



COLLINGWOOD

LIGHTING

LIGHTING INNOVATION

LANDSCAPE





INOVARA
GROUP

PREPARE TO BE ENLIGHTENED

Welcome to Inovara. The culmination and new home of Collingwood, Nobile, and Indigo. We bring together technically advanced skills, innovative backgrounds, sustainability-focused and forward-thinking minds, and data-driven lighting solutions to empower you and your business. With our support and expertise, you'll feel enabled to make confident, future-proof decisions that set new benchmarks in the development of sustainable properties within the residential, commercial, industrial, and landscape sectors.

But our commitment is far-reaching. Our pan-European presence is indeed strong, but with our newly formed capabilities and scalability, we have the stability and long-term market presence to grow yet further. Our focus is on you, your future, the sustainability of your projects, and our commitment in delivering an impeccably designed solution for your LED lighting integration. We can achieve all of that by being your global-thinking partner – a strategic partner, not just a product supplier.

































Introducing the strength of Inovara. Lighting innovation.



























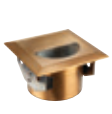











Contents

1	Introduction
2	Pictorial content
9	Amazing spaces
10	Light is an experience
12	Landscape
20	Ground lights
62	Step lights
76	Spike lights
94	Feature lights
102	Wall lights
112	Decorative lighting
120	Bollards
138	Uplights
144	Soffit downlights
148	Residential floodlights
158	Strip lights
176	Colour change
178	3 Simple steps
186	Ground lights
190	Feature lights
194	Wall lights
195	LED strip
196	Lighting controls
200	Products per driver matrix
204	Driver comparison
212	Accessories
214	Cable lengths guide
215	Information

Pictorial Contents

Ground lights			
GL016 Frosted Stainless Steel		GL016SSFD22 GL016SSFD27 GL016SSFD30 GL016SSFD40	46
GL016 Half Moon Stainless Steel		GL016SSHM22 GL016SSHM27 GL016SSHM30 GL016SSHM40	50
GL016 Low Glare Stainless Steel		GL016SSLG22F GL016SSLG22S GL016SSLG27F GL016SSLG27S GL016SSLG30F GL016SSLG30S GL016SSLG40F GL016SSLG40S	48
GL016 Round Stainless Steel		GL016RSS22F GL016RSS22S GL016RSS27F GL016RSS27S GL016RSS30F GL016RSS30S GL016RSS40F GL016RSS40S	45
GL016 Square Stainless Steel		GL016SQSS27F GL016SQSS30F GL016SQSS40F	51
GL016 Ultra Low Glare Stainless Steel		GL016USS22F GL016USS27F GL016USS30F GL016USS40F	49
GL018 C		GL018 C 27 GL018 C NW GL018 C WW	24
GL018 CAB		GL018 C AB WW	24
GL018 SQ		GL018 SQ WW	25
GL019 Frosted Stainless Steel		GL019SSFD22 GL019SSFD27 GL019SSFD30 GL019SSFD40	28
GL019 Half Moon Stainless Steel		GL019SSHM22 GL019SSHM27 GL019SSHM30 GL019SSHM40	32
GL019 Low Glare Stainless Steel		GL019SSLG22F GL019SSLG22S GL019SSLG27F GL019SSLG27S GL019SSLG30F GL019SSLG30S GL019SSLG40F GL019SSLG40S	30
GL019 Round Stainless Steel		GL019RSS22F GL019RSS22S GL019RSS27F GL019RSS27S GL019RSS30F GL019RSS30S GL019RSS40F GL019RSS40S	27
GL019 Square Stainless Steel		GL019SQSS30F GL019SQSS40F GL019SQSS40S	33
GL019 Ultra Low Glare Stainless Steel		GL019USS22F GL019USS22S GL019USS27F GL019USS27S GL019USS30F GL019USS30S GL019USS40F GL019USS40S	31
GL038 Stainless Steel		GL038SS22MF GL038SS27MF GL038SS30MF GL038SS40MF	
GL040 Frosted Stainless Steel		GL040SSFD22 GL040SSFD27 GL040SSFD30 GL040SSFD40	53
GL040 Half Moon Stainless Steel		GL040SSHM22 GL040SSHM27 GL040SSHM30 GL040SSHM40	56
GL040 Low Glare Stainless Steel		GL040SSLG22F GL040SSLG22S GL040SSLG27F GL040SSLG27S GL040SSLG30F GL040SSLG30S GL040SSLG40F GL040SSLG40S	54
GL040 Round Stainless Steel		GL040RSS22F GL040RSS22S GL040RSS27F GL040RSS27S GL040RSS30F GL040RSS30S GL040RSS40F GL040RSS40S	52
GL040 Ultra Low Glare Stainless Steel		GL040USS22F GL040USS22S GL040USS27F GL040USS27S GL040USS30F GL040USS30S GL040USS40F GL040USS40S	55
GL100 Stainless steel 1 window		GL100SSIW22 GL100SSIW27 GL100SSIW30 GL100SSIW40	34
GL100 Stainless steel 2 windows 1 direction		GL100SS2W22 GL100SS2W27 GL100SS2W30 GL100SS2W40	35
GL100 Stainless steel 2 windows 2 directions		GL100SS2O22 GL100SS2O27 GL100SS2O30 GL100SS2O40	35
GL100 Stainless steel 3 windows		GL100SS3W22 GL100SS3W27 GL100SS3W30 GL100SS3W40	36
GL100 Stainless steel 4 windows		GL100SS4W22 GL100SS4W27 GL100SS4W30 GL100SS4W40	37
GL200 Antique brass 1 window		GL200AXIX30	42
GL200 Antique brass 2 windows 1 direction		GL200AX2I30	42
GL200 Antique brass 2 windows 2 directions		GL200AX2230	42
GL200 Antique brass 3 windows		GL200AX3X30	43
GL200 Antique brass 4 windows		GL200AX4X30	43
GL200 Stainless steel 1 window		GL200DXIX27 GL200DXIX30 GL200DXIX40	39
GL200 Stainless steel 2 windows 1 direction		GL200DX2I27 GL200DX2I30 GL200DX2I40	39

Ground lights			
GL200 Stainless steel 2 windows 2 directions		GL200DX2227 GL200DX2230 GL200DX2240	39
GL200 Stainless steel 3 windows		GL200DX3X27 GL200DX3X30	40
GL200 Stainless steel 4 windows		GL200DX4X27 GL200DX4X30 GL200DX4X40	40
Tilt Mains ground light		GLTMFI47T30 GLTMFI65T30 GLTMSI19T30 GLTMSI47T30 GLTMSI65T30 GLTMSI93T30 GLTMS223T30	61
Ground lights accessories			
TUBE/50		TUBE/50	60
TUBE/68		TUBE/68	60
TUBE332		TUBE332	60
Step lights			
GL019 Eyelid Black		GL019BK22EL GL019BK27EL GL019BK30EL GL019BK40EL GL019E27BL GL019E30BL	66
GL019 Eyelid Stainless steel		GL019E27SS GL019E30SS GL019SS22EL GL019SS27EL GL019SS30EL GL019SS40EL	66
GL021		GL021 27 GL021 NW	70
GL022		GL022 27 GL022 NW GL022 WW	71
GL034 Stainless Steel		GL034SS22MF GL034SS27MF GL034SS30MF GL034SS40MF	69
Spike lights			
WL339		WL339WW	72
WL340 Antique brass		WL340AB27 WL340ABWW	73
WL340 Stainless steel		WL340WW	73
WL341		WL341NW WL341WW	74
WL342 Antique brass		WL342AB27 WL342AB30	75
WL342 Stainless steel		WL34227 WL342NW WL342WW	75
SL030 Stainless steel		SL030 F 27 SL030 F NW SL030 F WW	80
SL040A		SL040A F 27 SL040A F WW SL040A S 27 SL040A S NW SL040A S WW	81
SL130 Black		SL13027 SL13030 SL13040	80
SL220 Low Voltage Stainless Steel		SL220SS22XF SL220SS22XS SL220SS27XF SL220SS27XS SL220SS30XF SL220SS30XS SL220SS40XF SL220SS40XS	82
SL220 Mains Voltage Stainless Steel		SL220SS22MF SL220SS22MS SL220SS27MF SL220SS27MS SL220SS30MF SL220SS30MS SL220SS40MF SL220SS40MS	83
SL230 Black		SL230BWBX27 SL230BWBX30	86
SL230 Bronze		SL230ZWBX27 SL230ZWBX30	86
SL230 Mains Black		SL230BWBXM27 SL230BWBXM30	87
SL230 Mains Bronze		SL230ZWBXM30	87
SL230 Mains Stainless steel		SL230DWBXM27 SL230DWBXM30	87
SL230 Stainless steel		SL230DWBX30	86
SLM230 Mains Anthacite grey		SLM230SHA30	85
SLM230 Mains Black		SLM230SHB30	85
SLX230 Anthacite grey		SLX230SHA30	84
SLX230 Black		SLX230SHB30	84
Spydra 300mm Grey		SPYA3DCS SPYA3FCS	90
Spydra 300mm Black		SPYB3DCS SPYB3FCS	92
Spydra 600mm Grey		SPYA6DCS SPYA6FCS	91
Spydra 600mm Black		SPYB6DCS SPYB6FCS	93

Pictorial Contents

Spike lights accessories

GH220 Black		GH220B	89
GH220 Bronze		GH220Z	89
GH220 Stainless steel		GH220D	89
GS220 Black		GS220B	89
GS220 Bronze		GS220Z	89
GS220 Stainless steel		GS220D	89

Feature lights

Fountain		FOUX167N30	101
UL010 Stainless Steel		UL010SS22XF UL010SS27XF UL010SS30XF UL010SS40XF	100
UL030 Stainless Steel		UL030SS22XF UL030SS22XS UL030SS27XF UL030SS27XS UL030SS30XF UL030SS30XS UL030SS40XF UL030SS40XS	99

Wall lights

WL060 Silver		WL060 NW WL060 WW	110
WL070 Black		WL070BNBM27 WL070BNBM30 WL070BNBM40	107

WL070 Bronze		WL070ZNBM27 WL070ZNBM30	107
WL070 Copper		WL070CNBM27 WL070CNBM30	107
WL070 Silver		WL070SNBM27 WL070SNBM30 WL070SNBM40	107
WL075 Black		WL075BNBM27 WL075BNBM30 WL075BNBM40	109
WL075 Bronze		WL075ZNBM27 WL075ZNBM30	109
WL075 Silver		WL075SNBM27 WL075SNBM30 WL075SNBM40	109
WL160 Black		WL160 27 WL160 NW WL160 WW	110
WL220 Stainless Steel		WL220SS22MF WL220SS22MS WL220SS27MF WL220SS27MS WL220SS30MF WL220SS30MS WL220SS40MF WL220SS40MS	108

Decorative lighting









LED Lyte IP		LED LYTE IP 27 LED LYTE IP NW LED LYTE IP WW	117
LED Lyte IPT		LED LYTE IPT NW	118
ML01		ML01 27 ML01 NW ML01 WW	116
WL012 Black		WL012X30	111

WL012 Grey		WL012G30	111
WL041IP		WL041 IP NW WL041 IP WW	115

Decorative lighting accessories

LED Lyte 1M EXT		LED LYTE 1M EXT	119
LED Lyte 6WAY EXT		LED LYTE 6WAY EXT	119

Bollards

BL01 Chamfered iroko		BL01FIB30 BL01FIS30	126
BL01 Domed iroko		BL01DIB27 BL01DIB30 BL01DIB40 BL01DIS30	126
BL01 Pointed iroko		BL01PIB27 BL01PIB30 BL01PIS27 BL01PIS30 BL01PIS40	126
BL03 Chamfered iroko		BL03FIB30 BL03FIS27 BL03FIS30 BL03FIS40	127
BL03 Domed iroko		BL03DIB30 BL03DIS27 BL03DIS30	127
BL03 Pointed iroko		BL03PIB30 BL03PIS27 BL03PIS30 BL03PIS40	127
BOL100		BOL100X30	131
BOL101		BOL101X30	131

Bollards			
BOL201		BOL201X30	132
BOL300		BOL300X30	133
BOL301		BOL301X30	133
Luxi 54		OUI3624	137
Luxi 650		OUI3824	135
Slim Bollard 300mm Black		BLSBK3RDCS	134
Slim Bollard 300mm Corten		BLSCN3RDCS	134
Slim Bollard 300mm Grey		BLSAG3RDCS	134
Slim Bollard 600mm Black		BLSBK6RDCS	134
Slim Bollard 600mm Corten		BLSCN6RDCS	134
Slim Bollard 600mm Grey		BLSAG6RDCS	134

Bollards accessory

BOL LED Bracket		BOL LED BRACKET	128
-----------------	---	-----------------	-----

Uplights			
Volta LEDLINE 1000mm		LL1000AT27 LL1000AT30 LL1000MT27 LL1000MT30 LL1000WT27 LL1000WT30	143
Volta LEDLINE 500mm		LL500AT27 LL500AT30 LL500MT27 LL500MT30 LL500WT27 LL500WT30	142

Soffit downlights







H2 Pro Extreme CSP		H2EXTIA H2EXTIB H2EXTIW	147
--------------------	---	-------------------------------	-----

Residential floodlights





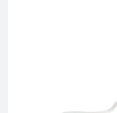



































FL01 Anthracite grey		FL01APCS FL01AXCS	152
FL01 Black		FL01BPCS FL01BXCS	152
FL01 White		FL01WPCS FL01WXCS	152
FL02 Anthracite grey		FL02APCS FL02AXCS	153
FL02 Black		FL02BPCS FL02BXCS	153
FL02 White		FL02WPCS FL02WXCS	153
FL03 Anthracite grey		FL03APCS FL03AXCS	155
FL03 Black		FL03BPCS FL03BXCS	155
FL03 White		FL03WPCS FL03WXCS	155





































FL05 Anthracite grey		FL05APCS FL05AXCS	156
FL05 Black		FL05BPCS FL05BXCS	156
FL05 White		FL05WPCS FL05WXCS	156
FL10		FL10BXCS	157

12 Strip lights











LSC82		LSC8227200 LSC8230200 LSC8240200	168
LSC84		LSC8427400 LSC8430400 LSC8440400	170
LSC85		LSC8527400 LSC8530400 LSC8540400	169
LSC86		LSC8627400 LSC8630400 LSC8640400	171
LSNS		LSNS7327030 LSNS7327050 LSNS7327100 LSNS7330030 LSNS7330050 LSNS7330100 LSNS7340030 LSNS7340050 LSNS7340100 LSNS7527030 LSNS7527050 LSNS7530030 LSNS7530050 LSNS7540030 LSNS7540050	172
LSNT		LSNT7327030 LSNT7327050 LSNT7327100 LSNT7330030 LSNT7330050 LSNT7330100 LSNT7340030 LSNT7340050 LSNT7340100 LSNT7527030 LSNT7527050 LSNT7530030 LSNT7530050 LSNT7540030 LSNT7540050	174

Pictorial Contents

Strip lights accessories								
LSNS1217B2P		LSNS1217B2P 164	LSNT1312EC		LSNT1312EC 164	GL090RGBW		GL090RGBW 187
LSNS1217E2P		LSNS1217E2P 164	LSNT1312L2P		LSNT1312L2P 164	LEDRGBWEXT		LEDRGBWEXT 185
LSNS1217EC		LSNS1217EC 164	LSNT1312MAL		LSNT1312MAL LSNT1312MPC 163	PR3011		PR3011 184
LSNS1217L2P		LSNS1217L2P 164	LSNT1312PAL		LSNT1312PAL 163	Tilt RGBW ground light		GLTXS119RGBW GLTXS147RGBW GLTXS165RGBW GLTXS193RGBW GLTXS223RGBW 193
LSNS1217MAL		LSNS1217MAL 162	LSNT1312PFL		LSNT1312PFL 163	UL010RGBW		UL010RGBW 190
LSNS1217MPC		LSNS1217MPC 162	LSNT1312PPC		LSNT1312PPC 163	UL030RGBW		UL030RGBW 191
LSNS1217PAL		LSNS1217PAL 162	LSNT1312R2P		LSNT1312R2P 164	WL070RGBW		WL070RGBW 194
LSNS1217PFL		LSNS1217PFL 162	LSNT1312SS		LSNT1312SS 164			
LSNS1217PPC		LSNS1217PPC 162	LSNT1312SSF		LSNT1312SSF 164	Colour change components		
LSNS1217R2P		LSNS1217R2P 164	RP28		RP28 122	CCDRV100DALI		CCDRV100DALI 182
LSNS1217SS		LSNS1217SS 164	SM28		SM28010 SM28020 122	CCDRV100DMX		CCDRV100DMX 182
LSNS1217SSF		LSNS1217SSF 164	Colour change			CCDRV100RF		CCDRV100RF 182
LSNT1312B2P		LSNT1312B2P 164	Fountain RGBW		FOUX167RGBW 189	CCDRV200DALI		CCDRV200DALI 182
LSNT1312E2P		LSNT1312E2P 164	GL016RGBW		GL016RGBW 186	CCDRV200DMX		CCDRV200DMX 182
						CCDRV200RF		CCDRV200RF 182

Colour change components								
CCDRV75DALI		CCDRV75DALI 182	LSD6024		LSD6024 206 - 211	PSDIM700		PSDIM700 206 - 211
CCDRV75DMX		CCDRV75DMX 182	PDCINTI-10V		PDCINTI-10V 206 - 211	PSDIM900		PSDIM900 206 - 211
CCDRV75RF		CCDRV75RF 182	PLD UNI-DRIVE 350MA		PLD UNI-DRIVE 350MA 206 - 211	PSDIP10024		PSDIP10024 206 - 211
CCREMOTEB		CCREMOTEB 180	PLD UNI-DRIVE 700MA		PLD UNI-DRIVE 700MA 206 - 211	PSDIP6024		PSDIP6024 206 - 211
CCRFCONVWIFI		CCRFCONVWIFI 181	PLDM70011		PLDM70011 206 - 211	PSIP15024		PSIP15024 206 - 211
CCWALLRFB		CCWALLRFB 180	PSI524		PSI524 206 - 211	PSIP25024		PSIP25024 206 - 211
CCWALLRFW		CCWALLRFW 180	PS3024B		PS3024B 206 - 211	PSIP35018W		PSIP35018W 206 - 211
CF505RGBW		CF505RGBW 185	PS7524		PS7524 206 - 211	PSIP3509W		PSIP3509W 206 - 211
COLLINGWOODRGBW APP		COLLINGWOODRGBW APP 181	PSDAL20024		PSDAL20024 206 - 211	PSIP70018W		PSIP70018W 206 - 211
CR575RGBW		CR575RGBW 185	PSDAL350M		PSDAL350M 206 - 211	PSIP70036W		PSIP70036W 206 - 211
			PSDAL700M		PSDAL700M 206 - 211	PSMD3024		PSMD3024 206 - 211
			PSDAL900M		PSDAL900M 206 - 211	PSMDIP10024		PSMDIP10024 206 - 211
			PSDIM180		PSDIM180 206 - 211			
			PSDIM350		PSDIM350 206 - 211			
						Lighting control general accessories		
						JB1		JB1 212

Pictorial Contents

14 Lighting control general accessories		
JB2		212
JB3		212
JB4		212
JB5		212
JB6		212
JB7		212
UY2 CONNECTOR		213
WC 5-9		212
WCR 275 BLACK		213
WCR 375 BLACK		213





Amazing spaces

**Your vision, your way,
created together**

We believe you have the ability to create amazing projects and we want to help you achieve it. Creating environments that put people's experience first and enhance everyday life are fundamental to our approach at Collingwood. Let's create an amazing space together.

#lightyourmoment



Light is an experience

There's lighting, and then there's lighting

Filling a landscape with light is easy, but bringing a space to life with light takes expertise. We thrive on making the most of spaces and taking your projects to the next level with our lighting design studio.

Our team of professional lighting designers are accredited LIA certified designers have decades of experience, providing bespoke lighting design solutions for our stockists and end contractors. We pride ourselves on providing a quality hassle free service, delivering quality, compliant, energy saving solutions on time.

What is included in our service?

- Customised designs built specifically for your needs.
- From single room to entire building projects.
- Quick, efficient and on budget service.
- Compliant lighting solutions.
- Value engineer service.
- We use Dialux and Relux to make sure we have the most effective software possible.
- We provide a full quote and solution.

All you need to do is provide us with a DWG or PDF plan of your project, and from there we can provide you with a full solution and quote.

Atmosphere with colour

Choosing the ideal CCT is essential to creating the perfect atmosphere for your project.



Ember
2200K



Warmest
2700K



Warm
3000K



Natural white
4000K



Wood / Sand
2200K - 2700K



Stone
3000K



Whites
4000K

Maximising materials with colour

Bring the best out of the materials in your project by using the ideal CCT (Correlated Colour Temperature).



Layering light for exteriors

Combining functional, feature and social lighting will make the most of an exterior space whilst adding depth to the lighting scheme.

① Functional lighting

Lights areas for specific tasks to take place in the space.

② Feature lighting

Provides points of focus and highlights elements of the space to add depth.

③ Social lighting

Creates ambience and a space that people will spend most of their time in.

Landscape



Landscape lighting

Adding depth to landscapes

Transforming any landscape with lighting design is as important as interior lighting. It can invigorate the environment and bring the space to life.

Incorporating lighting into landscape design

To amplify the quality of a landscape, lighting should be incorporated into the design. When it comes to landscape lighting, three key areas should be considered; functional areas, feature areas and entertainment areas. If consideration is taken for these, landscapes will have added depth and can really be brought to life.

Low-level decorative lighting

The correct lighting should be considered when illumination is required for a certain task, such as visibility or circulation. Pathways and storage areas usually require functional lighting but can be used as a layer of light that contributes to the overall landscape.

Feature areas

Sculptures, ponds and interesting plant life can form distinct features in a landscape design, but may be lost at night. Consider the most appropriate way to light them to ensure they become the focal point in a landscape.

Entertainment areas

Lighting in this area should be used to create ambience as it often becomes the most used area in a landscape. As such, it is a good idea to consider lighting at the start of the design. This can be further enhanced through the use of controls.

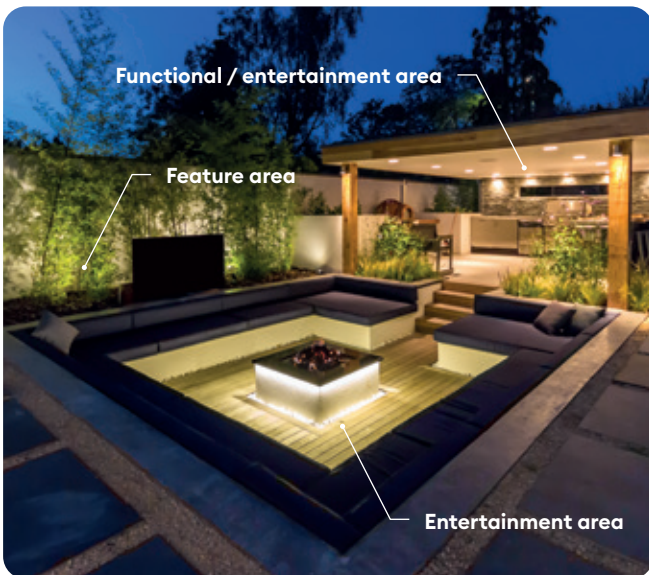

Maximising materials

Importance of colour temperature

Accentuating the materials in a landscape can be achieved by selecting a colour temperature that enhances the colour of the material being highlighted.

Wood / sand

Warmer tones found in materials such as these would be complimented by a colour temperature of 2200K - 3000K.

Stone

For featuring the natural components of stone, a colour temperature of 2700K - 3000K will be most suitable.

Whites

For white materials, such as painted brick or furniture, choose 4000K to emphasise the tones.



Finishes

The use of black, antique brass and bronze finishes are a popular trend with landscape lighting designers, and to accommodate this development we have just extended our offering to include even more varieties.

Black ground lights tap into the latest monochrome interior design trends. These ground lights are for decorative lit effects and ideal for placement on perimeters because they're not suitable for being walked or driven over.

Another design trend is for the use of warmer materials and body colours, such as antique brass and bronze. These finishes are particularly used in exterior spaces, alongside red, orange and brown hues, which are commonly found in wood, brick and stone.

Switchable drivers

Drivers designed for the ultimate flexibility. Turn any landscape product into a lumen switchable product via on-board dip switches, giving you the freedom during installation to achieve the perfect output for your garden design.

Non dimmable output:
150mA - 250mA - 350mA
500mA - 700mA

DRV150700



Triac dimmable output:
350mA - 500mA - 700mA

DRV350700TD



Atmosphere

The correct colour temperature is paramount for the choice of material you wish to highlight and the atmosphere you wish to create. Landscape designs are easily transformed by the correct colour temperature.

2200K



2700K



3000K



4000K



Flood Vs Spot

Choose the ideal beam angle to achieve the effect that you need.

Flood

Wash light over an area with a wider beam angle.

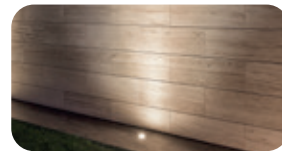

Spot

Concentrated beam of light with a narrower beam angle.

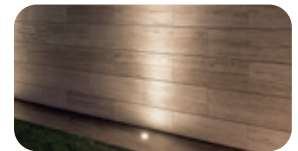

Textured surfaces vs. flat surfaces

When choosing a light fitting, it is imperative to consider the surface that the light will be used on. At this stage, it is a great opportunity to bring the materials to life and compliment the landscape design.

Textured surface

Use a spot, close to the surface, to graze light over the surface, highlighting the texture and adding depth to the surface.



Flat surfaces

Use a flood to wash light over the surface, highlighting the clean nature of the surface/design.



Landscape lighting

Environment Considerations

There are many considerations when designing an exterior lighting scheme, and they should always include the natural environment. Careful planning will ensure a lighting scheme which is both durable and impactful, whilst also remaining sympathetic to the environment.

Incorporating lighting into landscape design

Considerate lighting schemes reduce impacts on nocturnal animals

It is important to minimise any effects lighting has on nocturnal animals and insects such as bats, owls and moths. It is very important that bats specifically are taken into account when considering the need to light an area if they are known or suspected to use the area.

The amount of upwards light, and in particular blue light content, can impact them for many reasons, like survival and growth rates. Bats in the UK feed on insects and this missed opportunity can have a serious impact on them if they are missing the peak time of insect abundance (just after dusk). Other effects it can have is bats/wildlife being abandoned or becoming entombed in the roost, so when the entrance is lit up to the roost, they will be less inclined to leave their roosts in these conditions.

A range of low glare products as such as bollards, ground lights, spike lights and lighting controls to help support with illuminating areas.

Products available in 2200K keep blue light content to a minimum. Bollards, such as the black coated range are available in various sizes and with the low glare it has minimum up spill of lighting, making it suitable for areas where nocturnal animals such as bats, and any other wildlife that are affected by lighting.

The mini domed ground lights, GL100 and GL200 give out concentrated light sideways, so you can still illuminate a path for easy navigation and safety, whilst still protecting the environment from light pollution.

Control systems can offer various functions such as putting the lights on a timer or a sensor, so it is only used when needed.

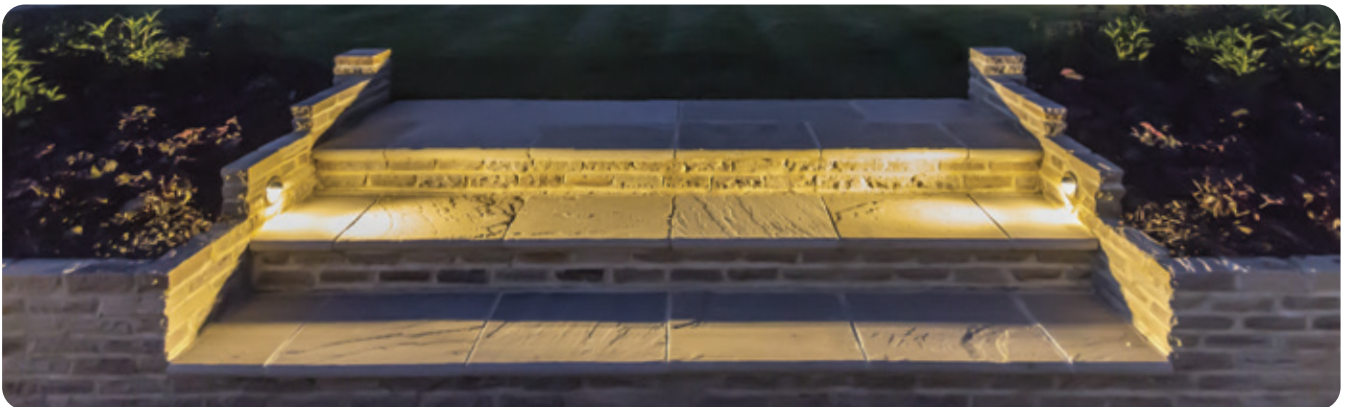

Patented underwater technology

IP68 rated lights are completely air tight and can be used underwater. Patented technology, unique to Collingwood, prevents water ingress from the back of the light, where the cable enters the product.

When designing a pond area, ensure that you are using IP68 rated products.

Our IP68 rated ground lights can withstand 1 bar pressure, meaning it can be installed up to a depth of 10 metres.



Coastal and pool areas

Material choice

Our landscape products are trusted by lighting specifiers and installers alike. This is thanks to superior product engineering and the use of durable and high-quality materials, including marine-grade stainless steel 316 and anodised aluminium.

Stainless steel 316

Unlike stainless steel 304, the 316 version has a higher resistance to corrosion meaning it is an excellent choice for coastal areas where the water and air contain high concentration levels of salt, and for around swimming pools where there is exposure to chlorine. Not only this, but the material is very durable against wear and tear, particularly important for products recessed in walkways and driveways. Our products go through vigorous salt mist testing to ensure they are corrosion resistant.

Anodised Aluminium

This electrochemical process increases the thickness of the natural oxide layer on the surface of the aluminium, so the colour becomes part of the material itself. This has benefits over the more commonly seen powder coated alternative because it will not fade, peel or flake, and maintains some of its metallic appearance. Anodised aluminium is also resistant to corrosion and scratches, but it is a softer metal compared to stainless steel 316 so should be considered based on the light fitting's intended install location. Anodising is one of the most durable surface finishes available, as well as beautiful.

As with all light fittings, both the light and the product will maintain a high-quality appearance if they are installed correctly and are regularly wiped clean with a soft, damp cloth.



Sustainable Lighting Solutions

What is Eco-Design?

Eco-design principles in lighting focus on creating sustainable, energy-efficient, and environmentally friendly lighting solutions. These principles aim to reduce the environmental impact of lighting systems throughout their lifecycle, from production and operation to disposal.

The European Community (EC) has taken a significant step towards environmentally friendly design of products with the Ecodesign Directive (EU Directive 2009/125/EC). In the lighting industry in particular, this guideline plays a crucial role in developing ever more efficient and sustainable LED products and thus making an important contribution to climate protection

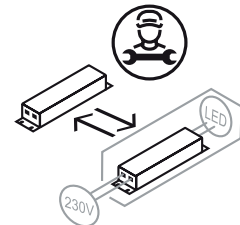
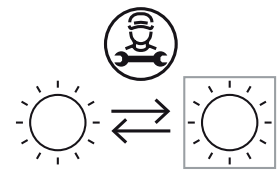

Eco-Design Principles

Here are some key aspects of Eco-design principles in lighting:

1. Energy Efficiency

Use of Efficient Light Sources: Prioritize LEDs and other high-efficiency lighting technologies that consume less power and produce more lumens per watt. **Adaptive Controls:** Incorporate technologies like dimmers, motion sensors, and daylight harvesting to adjust lighting based on occupancy and ambient light levels, reducing unnecessary energy consumption.

2. Durability and Longevity

Long Lifespan: Design lighting systems with components that last longer, reducing the frequency of replacements and associated waste. **Quality Materials:** Use durable, high-quality materials that can withstand wear and tear without compromising performance.

3. Minimizing Environmental Impact

Eco-Friendly Materials: Opt for non-toxic, recyclable, and sustainably sourced materials to reduce harm to the environment. **Reduced Emissions:** Select low-carbon manufacturing processes and design for reduced greenhouse gas emissions during production and use.

4. Optimal Light Quality

Human-Centric Design: Provide lighting that supports visual comfort, productivity, and well-being, reducing strain and fostering healthier environments. **Reduced Light Pollution:** Design fixtures to minimize glare, light trespass, and skyglow to protect ecosystems and improve visibility.

5. Innovation and Circularity

Modularity: Create systems with replaceable parts to extend overall product life. **Circular Economy Practices:** Design with a focus on reuse and recycling, ensuring that old fixtures and components can feed back into the production cycle.



A Modular Approach

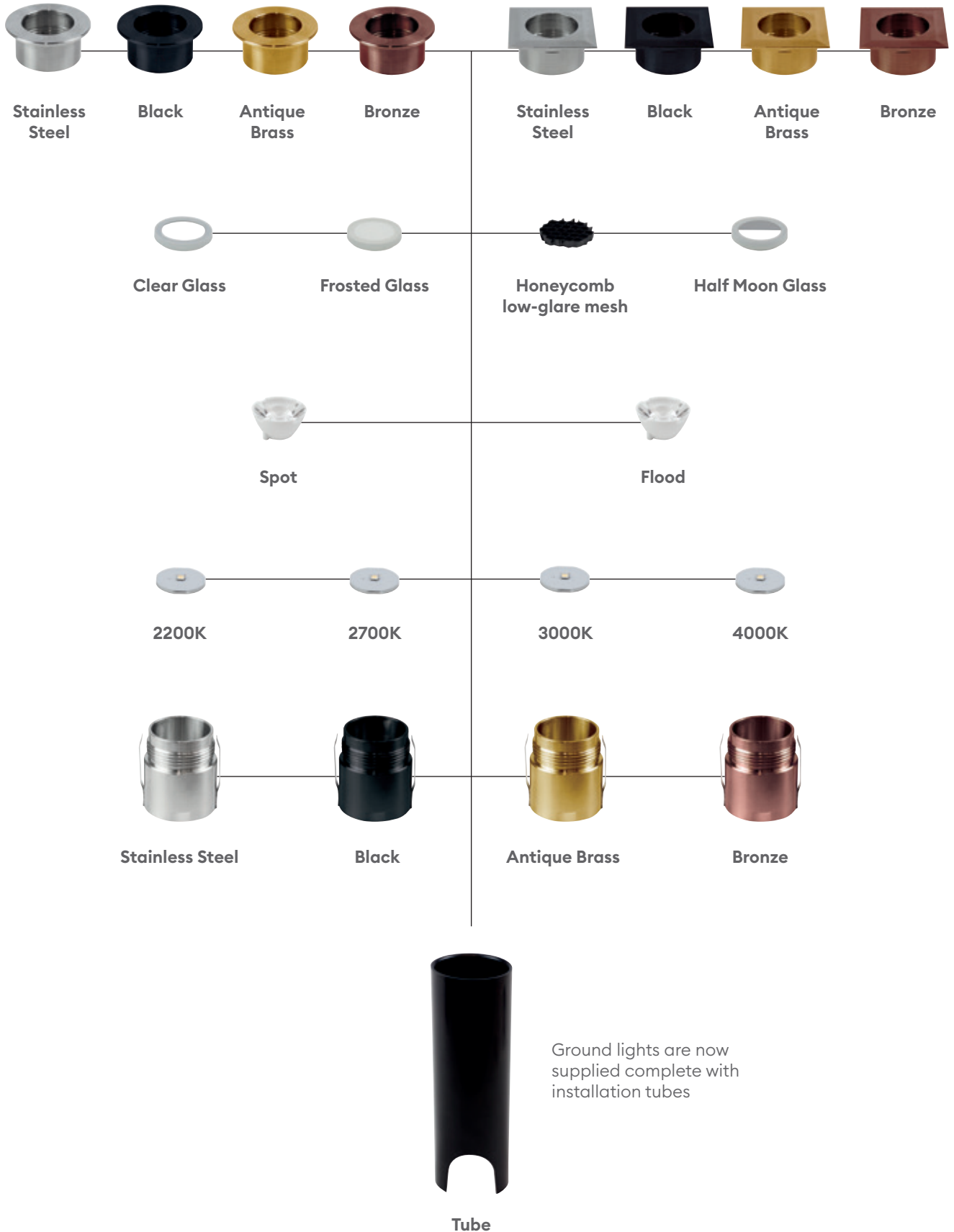

Ground Lights



Ground lights

Highlighting features inside and out

Using ground lights in any light design can transform your space from dark and uninspiring to a perfectly illuminated space to suit any requirement.

What type of ground light?

We offer the ideal ground light for every installation

- 1 High power ground light**

Powerful in output and large in scale, these fittings are ideal for illuminating tall trees and the façades of taller buildings.
- 2 Mid power ground light**

Choose these to light smaller façades, trees, shrubs and garden walls. These fittings can also be used inside large scale buildings to highlight architectural features.
- 3 Low power ground light**

Ideal for uplighting domestic façades and for use on wide steps and terraces with low level planting, these fittings can also be used inside to highlight architectural features. They can also be recessed into ceilings to provide small downlight options in display cases, alcoves or in showers.
- 4 Low glare ground light**

These fittings are ideal for use indoors or near terraces, seating areas and along pathways where people pass nearby.
- 5 Marker light**

Providing a subtle, diffused glow of light, these fittings are ideal for steps, pathways, driveways and car parks.
- 6 Underwater lighting**

IP68 and tested to 9m submersion.

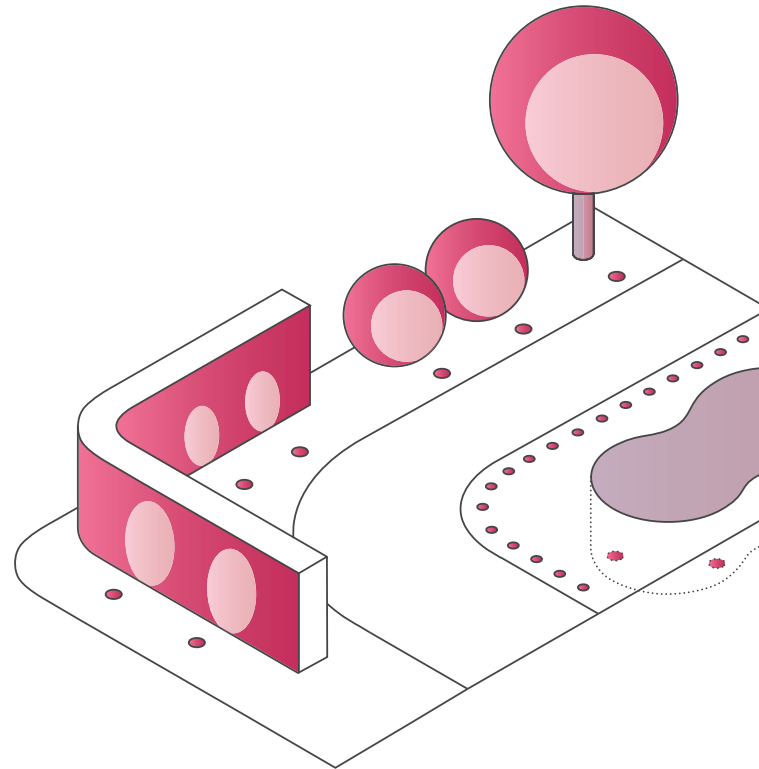

Choose the ideal size and output

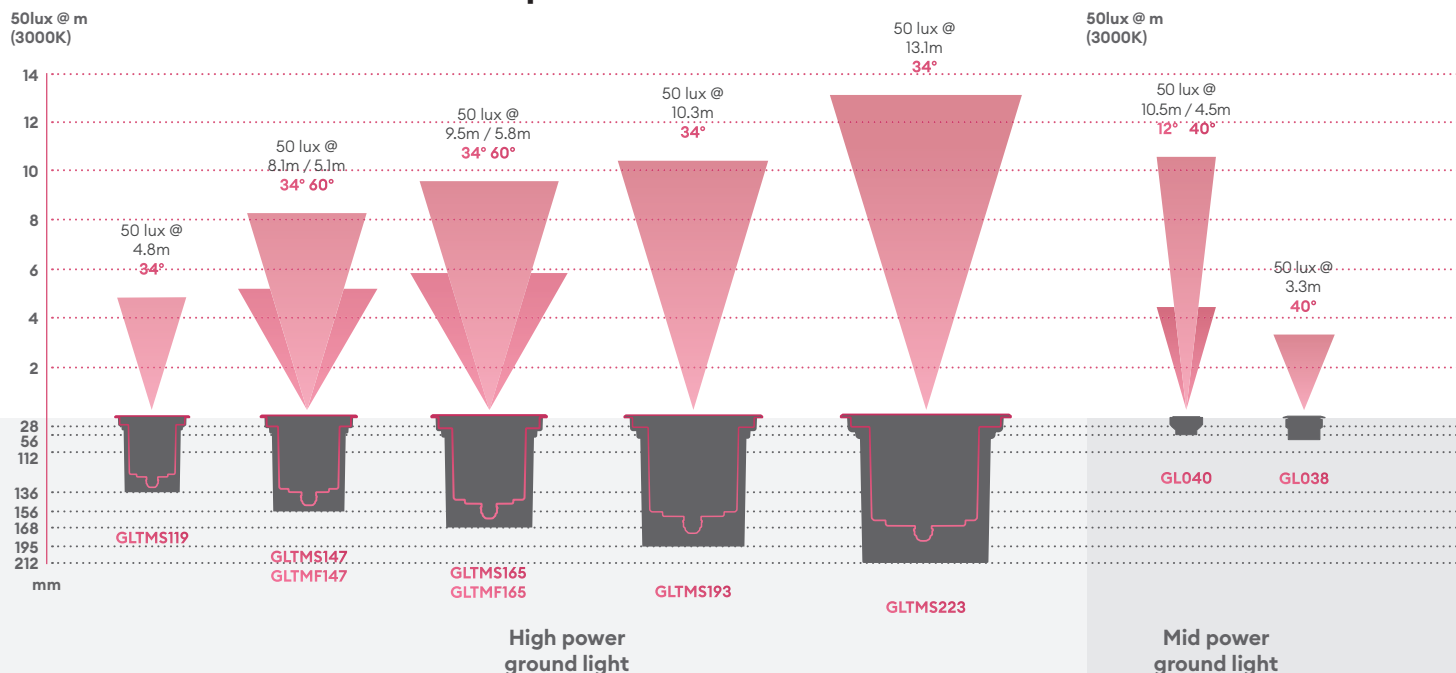

Tilt ground light adjustable light module

Our Tilt ground light has the flexibility to turn the dial to adjust beam angle direction by $\pm 25^\circ$

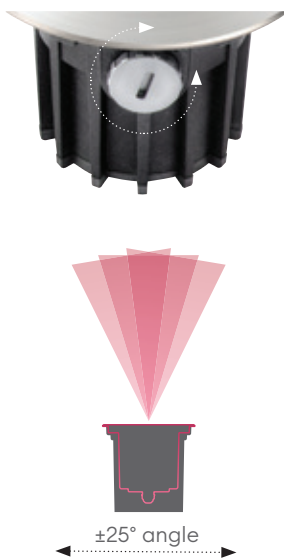

Patented underwater technology

IP68 rated ground lights are completely air tight and can be used under water.

Our low voltage ground lights utilise patented technology, unique to Collingwood, the anti syphon bung prevents water ingress when submerged, from where the cable enters the product.



Fitting guide

Product Code	Cut-out	Depth	Depth with tube
GLTMS119	119mm	129mm	136mm
GLTMF147 GLTMS147	147mm	156mm	168mm
GLTMF165 GLTMS165	165mm	250mm	278mm
GLTMS193	193mm	175mm	195mm
GLTMS223	223mm	183mm	212mm
GL016 Range	50mm	60mm	102mm
GL016 ULG	28mm	78mm	132mm
GL018 Range	28mm	50mm	N/A
GL019 Range	33mm	60mm	102mm
GL019 ULG	33mm	90mm	132mm
GL038	80-85mm	60mm	190mm
GL040	65mm	60mm	102mm
GL040 ULG	65mm	110mm	132mm
GL100	33mm	60mm	109mm
GL200	65mm	80mm	150mm

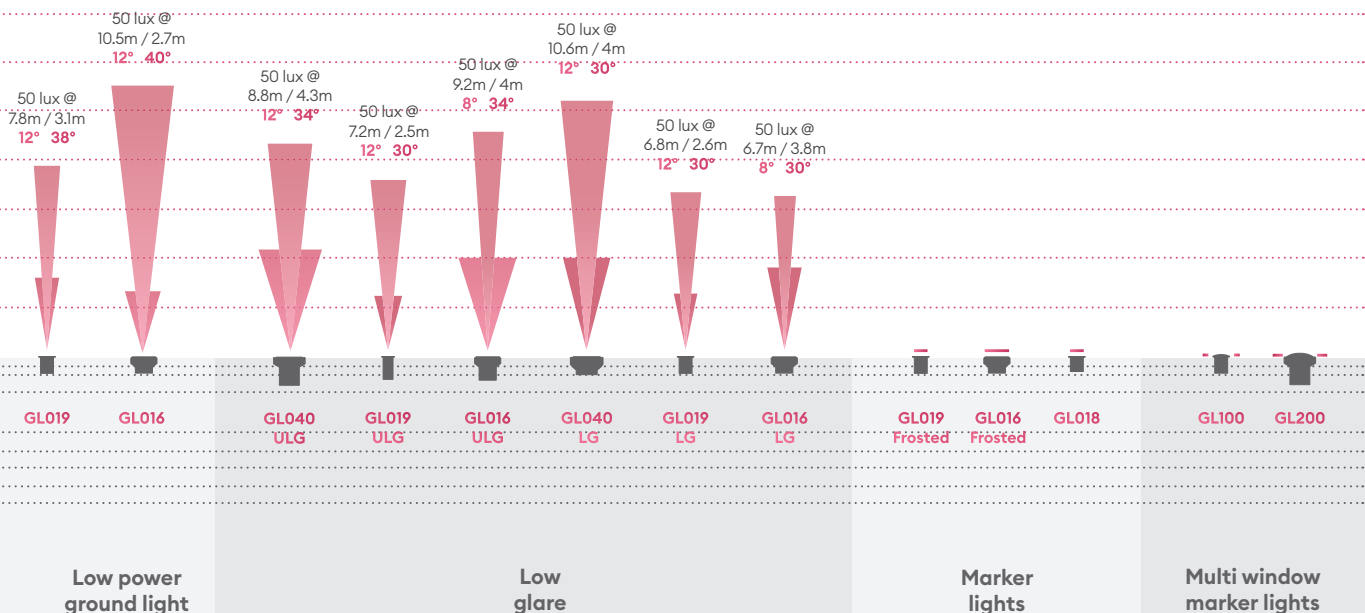

Ground Lights

0.5W 0.5W at 24V DC

 Frosted effect for low glare and soft lighting

 Low voltage ground light

Guarantee

7 years

Features & benefits

Robust cable for outdoor use
Shallow depth for easy installation
Coastal protected
Easy and quick installation with parallel wiring



GL018 C

0.4W, 4lm mini round marker ground light

Features

IK rating	IK07
IP rating	IP68
CSP switchable	Single CCT
Walk over / Drive over	Walk over (Stainless Steel & Antique Brass Only)
Input	24V DC
LED lifetime	L70 30,000h
Colour rendering index	CRI>80
Colour consistency	SDCM3

Installation information

Cut out size (mm)	28
Bathroom zone	0
Inrush current	N/A
Construction material	Stainless steel (316)
Suitable for coastal areas	Yes
Weight	300g
Maximum ambient temperature	35°C
SELV	N/A
Electric class (1, 2, 3)	3
Earth leakage	N/A

Photometrics @ 25°C

Product code	Finish	W	CCT	∠	lm	lm/W	Energy
GL018 C 27	Stainless steel	0.4W	2700K	120°	4	10	Exempt
GL018 C WW	Stainless steel	0.4W	3000K	120°	4	10	Exempt
GL018 C NW	Stainless steel	0.4W	4000K	120°	4	10	Exempt
GL018 C AB WW	Antique brass	0.4W	3000K	120°	4	10	Exempt

Energy rating is a reflection of the LED light source.

Wiring information

Cable / flying lead	1m (H05RN-F) rubberised cable (outside diameter: 6mm)
Type of wiring required	Parallel

Recommended LED drivers

See pages 200 - 203 for complete LED driver offer

Product code	Input	SELV	Dimming	Bathroom zone	Products per driver
PSI524	220-240V	Yes	Yes (with PDCINT1-10V)	0 (1 when dimming)	1-30
PS3024B	220-240V	Yes	Yes (with PDCINT1-10V)	0 (1 when dimming)	1-60
LSD6024	220-240V	Yes	Yes (with PDCINT1-10V)	0 (1 when dimming)	1-120

Accessories

JB1 / JB5 / JB6	IP68 waterproof connectors	Sold Separately	212
PDCINT1-10V	1-10V dimming interface for use with 24V LED drivers	Sold Separately	204

Beam angle: 120°

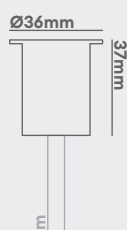
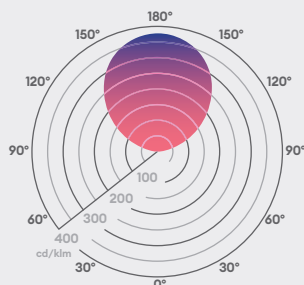

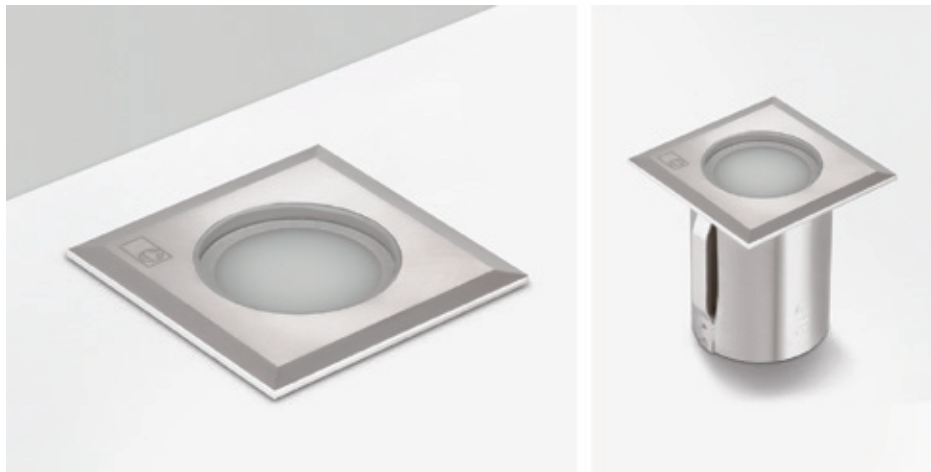

GL018 SQ

0.5W, 3lm square mini marker ground light

Features

IK rating	IK07
IP rating	IP68
CSP switchable	Single CCT
Walk over / Drive over	Walk over (Stainless Steel & Antique Brass Only)
Input	24V DC
LED lifetime	L70 30,000h
Colour rendering index	CRI>80
Colour consistency	SDCM3

Installation information

Cut out size (mm)	28
Bathroom zone	0
Inrush current	N/A
Construction material	Stainless steel (316)
Suitable for coastal areas	Yes
Weight	300g
Maximum ambient temperature	35°C
SELV	N/A
Electric class (1, 2, 3)	3
Earth leakage	N/A

Photometrics @ 25°C

Product code	Finish	W	CCT	∠°	lm	lm/W	Energy
GL018 SQ WW	Stainless steel	0.5W	3000K	120°	3	6	Exempt

Energy rating is a reflection of the LED light source.

Wiring information

Cable / flying lead	1m (H05RN-F) rubberised cable (outside diameter: 6mm)
Type of wiring required	Parallel

Recommended LED drivers

See pages 200 - 203 for complete LED driver offer

Product code	Input	SELV	Dimming	Bathroom zone	Products per driver
PSI524	220-240V	Yes	Yes (with PDCINT 1-10V)	0 (1 when dimming)	1-30
PS3024B	220-240V	Yes	Yes (with PDCINT 1-10V)	0 (1 when dimming)	1-60
LSD6024	220-240V	Yes	Yes (with PDCINT 1-10V)	0 (1 when dimming)	1-120

Accessories

JB1 / JB5 / JB6	IP68 waterproof connectors	Sold Separately	212
PDCINT1-10V	1-10V dimming interface for use with 24V LED drivers	Sold Separately	204

Ground Lights

0.5W 0.5W at 24V DC

 Frosted effect for low glare and soft lighting

 Low voltage ground light

Guarantee

3 years

Features & benefits

Square bezel for a different decorative effect

Robust cable for outdoor use

Shallow depth for easy installation

Easy and quick installation with parallel wiring

Beam angle: 120°

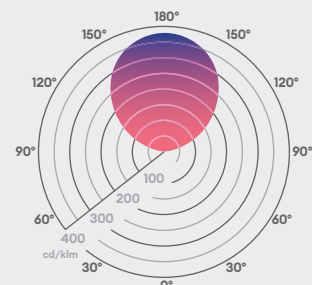

36x36mm

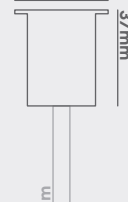





GL019 Round

Low Voltage Ground Light

Features

IK rating	IK07
IP rating	IP68
CSP switchable	Single CCT
Walk over / Drive over	Walk over (Stainless Steel & Antique Brass Only)
Input	150mA / 250mA / 350mA / 500mA / 700mA
LED lifetime	L70 70,000h
Colour rendering Index	CRI>80
Colour consistency	SDCM3

Installation information

Cut out size (mm)	33mm
Bathroom zone	0
Inrush current	N/A
Construction material	Stainless Steel
Suitable for coastal areas	Yes
Weight	204g
Maximum ambient temperature	55°C
SELV	N/A
Electric class (1, 2, 3)	3
Earth leakage	N/A

Photometrics @ 25°C

Product code	Finish	CCT	Beam angle	150mA			700mA			Energy
				W	lm	lm/W	W	lm	lm/W	
GL019RSS22F	Stainless steel 316	2200K	38°	0.4W	51	120	2.2W	196	89	100%
GL019RSS22S	Stainless steel 316	2200K	12°	0.4W	51	120	2.2W	196	89	100%
GL019RSS27F	Stainless steel 316	2700K	38°	0.4W	51	120	2.2W	169	89	100%
GL019RSS27S	Stainless steel 316	2700K	12°	0.4W	51	120	2.2W	169	89	100%
GL019RSS30F	Stainless steel 316	3000K	38°	0.4W	54	129	2.2W	210	95	100%
GL019RSS30S	Stainless steel 316	3000K	12°	0.4W	54	129	2.2W	210	95	100%
GL019RSS40F	Stainless steel 316	4000K	38°	0.4W	60	143	2.2W	234	106	100%
GL019RSS40S	Stainless steel 316	4000K	12°	0.4W	60	143	2.2W	234	106	100%

In the part code to replace your colour, change SS (Stainless Steel) to AB (Antique Brass) or BK (Black). Energy rating is a reflection of the LED light source.

Wiring information

Cable / flying lead	1m (H05RN-F) rubberised cable (outside diameter: 6mm)
Type of wiring required	Series

Recommended LED drivers

See pages 200 - 203 for complete LED driver offer

Product code	Input	SELV	Dimming	Bathroom zone	Products per driver
DRV150700 (all settings)	220-240V	Yes	No	N/A	1-13
DRV350700TD (350 & 500mA)	220-240V	Yes	Yes	N/A	3-12
DRV350700TD (700mA)	220-240V	Yes	Yes	N/A	3-8

Accessories

JB2 / JB4 / JB6	IP68 waterproof connectors	Sold Separately	212
WCR 275 BLACK	2-core rubber cable	Sold Separately	213

Ground Lights

IP68 IP68 perfect for internal or external applications

 Coastal protected

IK07 IK07 impact protection - walk over (Stainless Steel only)

Guarantee

7 years

Features & benefits

Supplied complete with installation tube

Low voltage ground light

SDCM3 ensuring uniform light appearance and consistency

CRI 80 providing true colour appearance

Available in a new 2200K setting to create a warm and cosy environment with minimal disruption to natural habitat

Compact yet powerful fitting

Robust cable for outdoor use

Available in an array of colours

Beam angle: 38° 12°

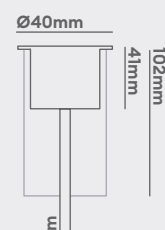
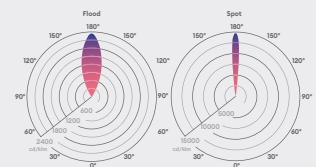

Ground Lights

IP68

IP68 perfect for internal or external applications



Coastal protected

IK07

IK07 impact protection - walk over (Stainless Steel only)

Guarantee

7 years

Features & benefits

Supplied complete with installation tube

Low voltage ground light

SDCM3 ensuring uniform light appearance and consistency

CRI 80 providing true colour appearance

Available in a new 2200K setting to create a warm and cosy environment with minimal disruption to natural habitat

Compact yet powerful fitting

Robust cable for outdoor use

Beam angle: 100°

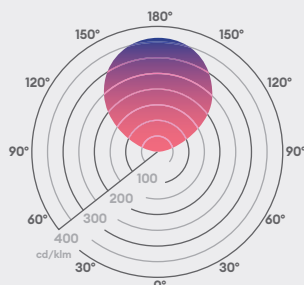

Ø40mm

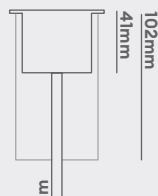

GL019 Frosted

Low Voltage Ground Light

Features

IK rating	IK07
IP rating	IP68
CSP switchable	Single CCT
Walk over / Drive over	Walk over (Stainless Steel & Antique Brass Only)
Input	150mA / 250mA / 350mA
LED lifetime	L70 70,000h
Colour rendering index	CRI>80
Colour consistency	SDCM3

Installation information

Cut out size (mm)	33mm
Bathroom zone	0
Inrush current	N/A
Construction material	Stainless Steel
Suitable for coastal areas	Yes
Weight	196g
Maximum ambient temperature	55°C
SELV	N/A
Electric class (1, 2, 3)	3
Earth leakage	N/A

Photometrics @ 25°C

Product code	Finish	CCT	Beam angle	150mA			350mA			Energy
				W	lm	lm/W	W	lm	lm/W	
GL019SSFD22	Stainless steel 316	2200K	100°	0.4W	11	27	1W	27	27	A C
GL019SSFD27	Stainless steel 316	2700K	100°	0.4W	13	33	1W	32	32	A C
GL019SSFD30	Stainless steel 316	3000K	100°	0.4W	13	33	1W	32	32	A C
GL019SSFD40	Stainless steel 316	4000K	100°	0.4W	13	33	1W	32	32	A C

In the part code to replace your colour change SS (Stainless Steel) to AB (Antique Brass) or BK (Black). **Important:** AB finish is made to order. Energy rating is a reflection of the LED light source.

Wiring information

Cable / flying lead	1m (H05RN-F) rubberised cable (outside diameter: 6mm)
Type of wiring required	Series

Recommended LED drivers

See pages 200 - 203 for complete LED driver offer

Product code	Input	SELV	Dimming	Bathroom zone	Products per driver
DRV150700 (150-350mA)	220-240V	Yes	No	N/A	1-13
DRV350700TD (350mA)	220-240V	Yes	Yes	N/A	3-12
PSIP35018W	220-240V	Yes	No	1	8-15

Accessories

JB2 / JB4 / JB6	IP68 waterproof connectors	Sold Separately	212
WCR 275 BLACK	2-core rubber cable	Sold Separately	213



Ground Lights

IP68

IP68 perfect for internal or external applications



Coastal protected

IK07

IK07 impact protection - walk over (Stainless Steel only)

Guarantee

7 years

Features & benefits

Supplied complete with installation tube

Low voltage ground light

SDCM3 ensuring uniform light appearance and consistency

CRI 80 providing true colour appearance

Available in a new 2200K setting to create a warm and cosy environment with minimal disruption to natural habitat

Compact yet powerful fitting

Robust cable for outdoor use

Available in an array of colours

Beam angle: 30° 12°

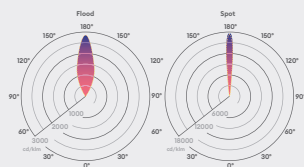

Ø40mm

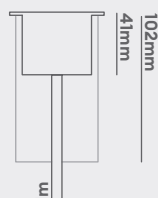

GL019 Low Glare

Low Voltage Ground Light

Features

IK rating	IK07
IP rating	IP68
CSP switchable	Single CCT
Walk over / Drive over	Walk over (Stainless Steel & Antique Brass Only)
Input	150mA / 250mA / 350mA / 500mA / 700mA
LED lifetime	L70 70,000h
Colour rendering Index	CRI>80
Colour consistency	SDCM3

Installation information

Cut out size (mm)	33mm
Bathroom zone	0
Inrush current	N/A
Construction material	Stainless Steel
Suitable for coastal areas	Yes
Weight	204g
Maximum ambient temperature	55°C
SELV	N/A
Electric class (1, 2, 3)	3
Earth leakage	N/A

Photometrics @ 25°C

Product code	Finish	CCT	Beam angle	150mA			700mA			Energy
				W	lm	lm/W	W	lm	lm/W	
GL019SSLG22F	Stainless steel 316	2200K	30°	0.4W	31	74	2.2W	120	55	1 D
GL019SSLG22S	Stainless steel 316	2200K	12°	0.4W	31	74	2.2W	120	55	1 D
GL019SSLG27F	Stainless steel 316	2700K	30°	0.4W	31	74	2.2W	120	55	1 D
GL019SSLG27S	Stainless steel 316	2700K	12°	0.4W	31	74	2.2W	120	55	1 D
GL019SSLG30F	Stainless steel 316	3000K	30°	0.4W	33	79	2.2W	128	58	1 D
GL019SSLG30S	Stainless steel 316	3000K	12°	0.4W	33	79	2.2W	128	58	1 D
GL019SSLG40F	Stainless steel 316	4000K	30°	0.4W	37	87	2.2W	143	65	1 D
GL019SSLG40S	Stainless steel 316	4000K	12°	0.4W	37	87	2.2W	143	65	1 D

In the part code to replace your colour, change SS (Stainless Steel) to AB (Antique Brass) or BK (Black). **Important:** BK & AB finish are made to order. Energy rating is a reflection of the LED light source.

Wiring information

Cable / flying lead	1m (H05RN-F) rubberised cable (outside diameter: 6mm)
Type of wiring required	Series

Recommended LED drivers

See pages 200 - 203 for complete LED driver offer

Product code	Input	SELV	Dimming	Bathroom zone	Products per driver
DRV150700 (all settings)	220-240V	Yes	No	N/A	1-13
DRV350700TD (350 & 500mA)	220-240V	Yes	Yes	N/A	3-12
DRV350700TD (700mA)	220-240V	Yes	Yes	N/A	3-8

Accessories

JB2 / JB4 / JB6	IP68 waterproof connectors	Sold Separately	212
WCR 275 BLACK	2-core rubber cable	Sold Separately	213



GL019 Ultra Low Glare

Low Voltage Ground Light

Features

IK rating	IK07
IP rating	IP68
CSP switchable	Single CCT
Walk over / Drive over	Walk over (Stainless Steel & Antique Brass Only)
Input	150mA / 250mA / 350mA
LED lifetime	L70 70,000h
Colour rendering index	CRI>80
Colour consistency	SDCM3

Installation information

Cut out size (mm)	33mm
Bathroom zone	0
Inrush current	N/A
Construction material	Stainless Steel
Suitable for coastal areas	Yes
Weight	204g
Maximum ambient temperature	55°C
SELV	N/A
Electric class (1, 2, 3)	3
Earth leakage	N/A

Photometrics @ 25°C

Product code	Finish	CCT	Beam angle	150mA			350mA			Energy
				W	lm	lm/W	W	lm	lm/W	
GL019USS22F	Stainless steel 316	2200K	38°	0.4W	36	85	1W	77	77	D
GL019USS22S	Stainless steel 316	2200K	12°	0.4W	41	98	1W	89	89	D
GL019USS27F	Stainless steel 316	2700K	38°	0.4W	36	85	1W	77	77	D
GL019USS27S	Stainless steel 316	2700K	12°	0.4W	41	98	1W	89	89	D
GL019USS30F	Stainless steel 316	3000K	38°	0.4W	38	90	1W	82	82	D
GL019USS30S	Stainless steel 316	3000K	12°	0.4W	44	105	1W	95	95	D
GL019USS40F	Stainless steel 316	4000K	38°	0.4W	42	101	1W	91	91	D
GL019USS40S	Stainless steel 316	4000K	12°	0.4W	49	117	1W	106	106	D

In the part code to replace your colour change SS (Stainless Steel) to AB (Antique Brass) or BK (Black). **Important:** AB finish is made to order. Energy rating is a reflection of the LED light source.

Wiring information

Cable / flying lead	1m (H05RN-F) rubberised cable (outside diameter: 6mm)
Type of wiring required	Series

Recommended LED drivers

See pages 200 - 203 for complete LED driver offer

Product code	Input	SELV	Dimming	Bathroom zone	Products per driver
DRV150700 (all settings)	220-240V	Yes	No	N/A	1-13
DRV350700TD (350mA)	220-240V	Yes	Yes	N/A	3-12
PSIP35018W	220-240V	Yes	No	1	8-16

Accessories

JB2 / JB4 / JB6	IP68 waterproof connectors	Sold Separately	212
WCR 275 BLACK	2-core rubber cable	Sold Separately	213

Ground Lights

IP68 IP68 perfect for internal or external applications

 Coastal protected

IK07 IK07 impact protection - walk over (Stainless Steel only)

Guarantee

7 years

Features & benefits

Supplied complete with installation tube

Low voltage ground light

SDCM3 ensuring uniform light appearance and consistency

CRI 80 providing true colour appearance

Available in a new 2200K setting to create a warm and cosy environment with minimal disruption to natural habitat

Compact yet powerful fitting

Robust cable for outdoor use

Available in an array of colours

Beam angle: 38° 12°

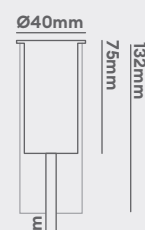
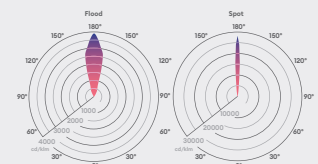

Ground Lights

IP68

IP68 perfect for internal or external applications



Coastal protected

IK07

IK07 impact protection - walk over (Stainless Steel only)

Guarantee

7 years

Features & benefits

Supplied complete with installation tube

Low voltage ground light

SDCM3 ensuring uniform light appearance and consistency

CRI 80 providing true colour appearance

Available in a new 2200K setting to create a warm and cosy environment with minimal disruption to natural habitat

Compact yet powerful fitting

Robust cable for outdoor use

Available in an array of colours

Beam angle: 38°

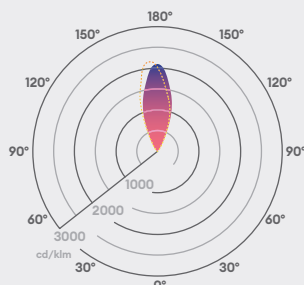

Ø40mm

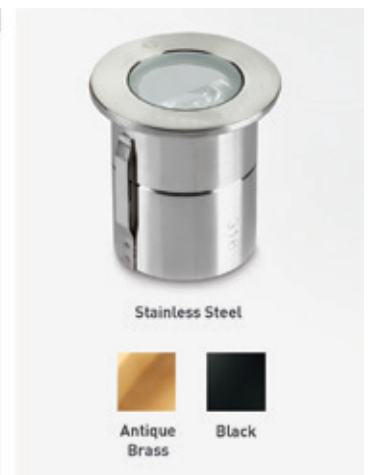
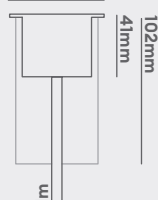

GL019 Half Moon

Low Voltage Ground Light

Features

IK rating	IK07
IP rating	IP68
CSP switchable	Single CCT
Walk over / Drive over	Walk over (Stainless Steel & Antique Brass Only)
Input	150mA / 250mA / 350mA / 500mA / 700mA
LED lifetime	L70 70,000h
Colour rendering Index	CRI>80
Colour consistency	SDCM3

Installation information

Cut out size (mm)	33mm
Bathroom zone	0
Inrush current	N/A
Construction material	Stainless Steel
Suitable for coastal areas	Yes
Weight	204g
Maximum ambient temperature	55°C
SELV	N/A
Electric class (1, 2, 3)	3
Earth leakage	N/A

Photometrics @ 25°C

Product code	Finish	CCT	Beam angle	150mA			700mA			Energy
				W	lm	lm/W	W	lm	lm/W	
GL019SSHM22	Stainless steel 316	2200K	38°	0.4W	34	80	2.2W	131	60	1 D
GL019SSHM27	Stainless steel 316	2700K	38°	0.4W	34	80	2.2W	131	60	1 D
GL019SSHM30	Stainless steel 316	3000K	38°	0.4W	36	86	2.2W	140	64	1 D
GL019SSHM40	Stainless steel 316	4000K	38°	0.4W	40	95	2.2W	156	71	1 D

In the part code to replace your colour change SS (Stainless Steel) to AB (Antique Brass) or BK (Black). **Important:** All finishes are made to order. Energy rating is a reflection of the LED light source.

Wiring information

Cable / flying lead	1m (H05RN-F) rubberised cable (outside diameter: 6mm)
Type of wiring required	Series

Recommended LED drivers

See pages 200 - 203 for complete LED driver offer

Product code	Input	SELV	Dimming	Bathroom zone	Products per driver
DRV150700 (all settings)	220-240V	Yes	No	N/A	1-13
DRV350700TD (350 & 500mA)	220-240V	Yes	Yes	N/A	3-12
DRV350700TD (700mA)	220-240V	Yes	Yes	N/A	3-8

Accessories

JB2 / JB4 / JB6	IP68 waterproof connectors	Sold Separately	212
WCR 275 BLACK	2-core rubber cable	Sold Separately	213



GL019 Square

Low Voltage Ground Light

Features

IK rating	IK07
IP rating	IP68
CSP switchable	Single CCT
Walk over / Drive over	Walk over (Stainless Steel & Antique Brass Only)
Input	150mA / 250mA / 350mA / 500mA / 700mA
LED lifetime	L70 70,000h
Colour rendering Index	CRI>80
Colour consistency	SDCM3

Installation information

Cut out size (mm)	33mm
Bathroom zone	0
Inrush current	N/A
Construction material	Stainless Steel
Suitable for coastal areas	Yes
Weight	204g
Maximum ambient temperature	55°C
SELV	N/A
Electric class (1, 2, 3)	3
Earth leakage	N/A

Photometrics @ 25°C

Product code	Finish	CCT	Beam angle	150mA			700mA			Energy
				W	lm	lm/W	W	lm	lm/W	
GL019SQSS30F	Stainless steel 316	3000K	38°	0.4W	54	129	2.2W	210	95	
GL019SQSS40F	Stainless steel 316	4000K	38°	0.4W	60	143	2.2W	234	106	
GL019SQSS40S	Stainless steel 316	4000K	12°	0.4W	60	143	2.2W	234	106	

In the part code to replace your colour, change SS (Stainless Steel) to AB (Antique Brass) or BK (Black). **Important:** BK & AB finish are made to order. Energy rating is a reflection of the LED light source.

Wiring information

Cable / flying lead	1m (H05RN-F) rubberised cable (outside diameter: 6mm)
Type of wiring required	Series

Recommended LED drivers

See pages 200 - 203 for complete LED driver offer

Product code	Input	SELV	Dimming	Bathroom zone	Products per driver
DRV150700 (all settings)	220-240V	Yes	No	N/A	1-13
DRV350700TD (350 & 500mA)	220-240V	Yes	Yes	N/A	3-12
DRV350700TD (700mA)	220-240V	Yes	Yes	N/A	3-8

Accessories

JB2 / JB4 / JB6	IP68 waterproof connectors	Sold Separately	212
WCR 275 BLACK	2-core rubber cable	Sold Separately	213

Ground Lights

IP68 IP68 perfect for internal or external applications

Coastal protected

IK07 IK07 impact protection - walk over (Stainless Steel only)

Guarantee

7 years

Features & benefits

Supplied complete with installation tube

Low voltage ground light

SDCM3 ensuring uniform light appearance and consistency

CRI 80 providing true colour appearance

Available in a new 2200K setting to create a warm and cosy environment with minimal disruption to natural habitat

Compact yet powerful fitting

Robust cable for outdoor use

Available in an array of colours

Beam angle: 38° 12°

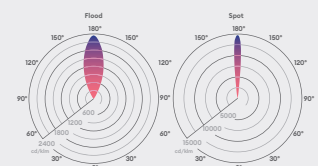

40x40mm

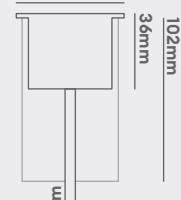

Ground Lights

IP68

IP68 perfect for internal or external applications



Coastal protected

IK07

IK07 impact protection - walk over (Stainless Steel only)

Guarantee

7 years

Features & benefits

Supplied complete with installation tube

Low voltage ground light

Walk over ground light ideal for paths or steps

SDCM3 ensuring uniform light appearance and consistency

CRI 80 providing true colour appearance

Available in a new 2200K setting to create a warm and cosy environment with minimal disruption to natural habitat

Long-lifetime of 70,000hrs

Available in an array of colours

Beam angle: 75°

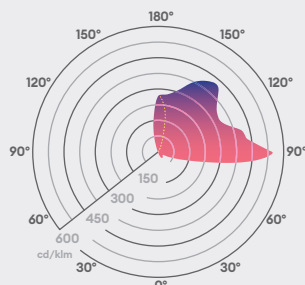

Ø40mm

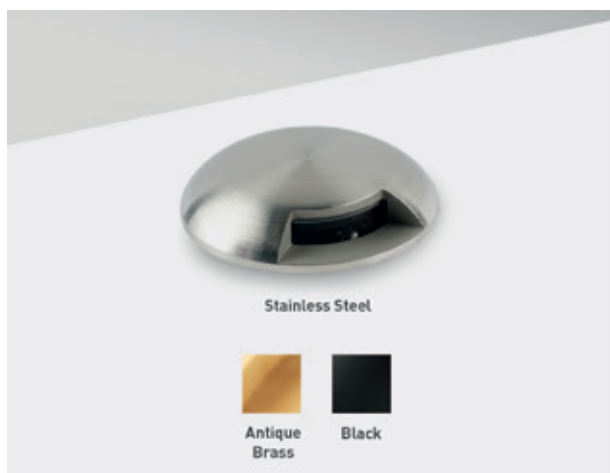
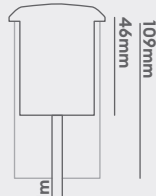

GL100 1 window

Domed Ground Light

Features

IK rating	IK07
IP rating	IP68
CSP switchable	Single CCT
Walk over / Drive over	Walk over (Stainless Steel & Antique Brass Only)
Input	150mA / 250mA / 350mA / 500mA / 700mA
LED lifetime	L70 70,000h
Colour rendering Index	CRI>80
Colour consistency	SDCM3

Installation information

Cut out size (mm)	33
Bathroom zone	0
Inrush current	N/A
Construction material	Stainless Steel
Suitable for coastal areas	Yes
Weight	GL100AB: 236g, GL100BK: TBC, GL100SS: 221g
Maximum ambient temperature	55°C
SELV	N/A
Electric class (1, 2, 3)	3
Earth leakage	N/A

Photometrics @ 25°C

Product code	Finish	Window	CCT	∠°	150mA			700mA			Energy
					W	lm	lm/W	W	lm	lm/W	
GL100SS1W22	Stainless steel 316	1 Window	2200K	75°	0.4W	1	3	2.2W	5	2	A D
GL100SS1W27	Stainless steel 316	1 Window	2700K	75°	0.4W	1	3	2.2W	5	2	A D
GL100SS1W30	Stainless steel 316	1 Window	3000K	75°	0.4W	1	3	2.2W	6	3	A D
GL100SS1W40	Stainless steel 316	1 Window	4000K	75°	0.4W	2	4	2.2W	6	3	A D

In the part code to replace your colour change SS (Stainless Steel) to AB (Antique Brass) or BK (Black). **Important:** BK finish is made to order. Energy rating is a reflection of the LED light source.

Wiring information

Cable / flying lead	1m (H05RN-F) rubberised cable (outside diameter: 6mm)
Type of wiring required	Series

Recommended LED drivers

See pages 200 - 203 for complete LED driver offer

Product code	Input	SELV	Dimming	Bathroom zone	Products per driver
DRV150700 (all settings)	220-240V	Yes	No	N/A	1-13
DRV350700TD (350 & 500mA)	220-240V	Yes	Yes	N/A	3-12
DRV350700TD (700mA)	220-240V	Yes	Yes	N/A	3-8

Accessories

JB2 / JB4 / JB6	IP68 waterproof connectors	Sold Separately	212
WCR 275 BLACK	2-core rubber cable	Sold Separately	213



GL100 2 windows 2 directions

Domed Ground Light

Features

IK rating	IK07
IP rating	IP68
CSP switchable	Single CCT
Walk over / Drive over	Walk over (Stainless Steel & Antique Brass Only)
Input	150mA / 250mA / 350mA / 500mA / 700mA
LED lifetime	L70 70,000h
Colour rendering Index	CRI>80
Colour consistency	SDCM3

Installation information

Cut out size (mm)	33
Bathroom zone	0
Inrush current	N/A
Construction material	Stainless Steel
Suitable for coastal areas	Yes
Weight	GL100AB: 231g, GL100BK: TBC, GL100SS: 217g
Maximum ambient temperature	55°C
SELV	N/A
Electric class (1, 2, 3)	3
Earth leakage	N/A

Photometrics @ 25°C

Product code	Finish	Window	CCT	∠°	150mA			700mA			Energy
					W	lm	lm/W	W	lm	lm/W	
GL100SS2O22	Stainless steel 316	2 Windows 2 Directions	2200K	75°	0.4W	3	6	2.2W	10	5	
GL100SS2O27	Stainless steel 316	2 Windows 2 Directions	2700K	75°	0.4W	3	6	2.2W	10	5	
GL100SS2O30	Stainless steel 316	2 Windows 2 Directions	3000K	75°	0.4W	3	7	2.2W	11	5	
GL100SS2O40	Stainless steel 316	2 Windows 2 Directions	4000K	75°	0.4W	3	8	2.2W	12	6	
GL100SS2W22	Stainless steel 316	2 Windows 1 Direction	2200K	75°	0.4W	3	6	2.2W	10	5	
GL100SS2W27	Stainless steel 316	2 Windows 1 Direction	2700K	75°	0.4W	3	6	2.2W	10	5	
GL100SS2W30	Stainless steel 316	2 Windows 1 Direction	3000K	75°	0.4W	3	7	2.2W	11	5	
GL100SS2W40	Stainless steel 316	2 Windows 1 Direction	4000K	75°	0.4W	3	8	2.2W	12	6	

In the part code to replace your colour change SS (Stainless Steel) to AB (Antique Brass) or BK (Black). **Important:** BK finish is made to order. Energy rating is a reflection of the LED light source.

Wiring information

Cable / flying lead	1m (H05RN-F) rubberised cable (outside diameter: 6mm)
Type of wiring required	Series

Recommended LED drivers

See pages 200 - 203 for complete LED driver offer

Product code	Input	SELV	Dimming	Bathroom zone	Products per driver
DRV150700 (all settings)	220-240V	Yes	No	N/A	1-13
DRV350700TD (350 & 500mA)	220-240V	Yes	Yes	N/A	3-12
DRV350700TD (700mA)	220-240V	Yes	Yes	N/A	3-8

Accessories

JB2 / JB4 / JB6	IP68 waterproof connectors	Sold Separately	212
-----------------	----------------------------	-----------------	-----

Ground Lights

IP68 IP68 perfect for internal or external applications

Coastal protected

IK07 IK07 impact protection - walk over (Stainless Steel only)

Guarantee

7 years

Features & benefits

Supplied complete with installation tube

Low voltage ground light

Walk over ground light ideal for paths or steps

SDCM3 ensuring uniform light appearance and consistency

CRI 80 providing true colour appearance

Available in a new 2200K setting to create a warm and cosy environment with minimal disruption to natural habitat

Long-lifetime of 70,000hrs

Available in an array of colours

Beam angle: 75°

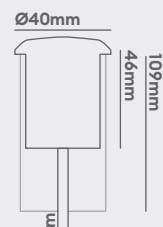
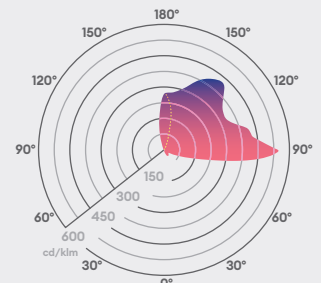

Ground Lights

IP68 IP68 perfect for internal or external applications



Coastal protected

IK07 IK07 impact protection - walk over (Stainless Steel only)

Guarantee

7 years

Features & benefits

Supplied complete with installation tube

Low voltage ground light

Walk over ground light ideal for paths or steps

SDCM3 ensuring uniform light appearance and consistency

CRI 80 providing true colour appearance

Available in a new 2200K setting to create a warm and cosy environment with minimal disruption to natural habitat

Long-lifetime of 70,000hrs

Available in an array of colours

Beam angle: 75°

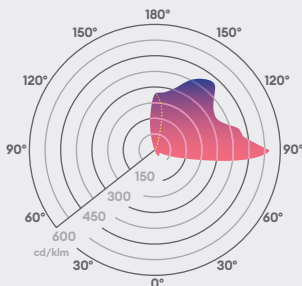

Ø40mm

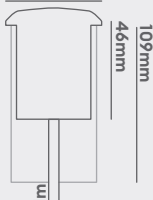

GL100 3 windows

Domed Ground Light

Features

IK rating	IK07
IP rating	IP68
CSP switchable	Single CCT
Walk over / Drive over	Walk over (Stainless Steel & Antique Brass Only)
Input	150mA / 250mA / 350mA / 500mA / 700mA
LED lifetime	L70 70,000h
Colour rendering Index	CRI>80
Colour consistency	SDCM3

Installation information

Cut out size (mm)	33
Bathroom zone	0
Inrush current	N/A
Construction material	Stainless Steel
Suitable for coastal areas	Yes
Weight	GL100AB: 228g, GL100BK: TBC, GL100SS: 215g
Maximum ambient temperature	55°C
SELV	N/A
Electric class (1, 2, 3)	3
Earth leakage	N/A

Photometrics @ 25°C

Product code	Finish	Window	CCT	Beam angle	150mA			700mA			Energy
					W	lm	lm/W	W	lm	lm/W	
GL100SS3W22	Stainless steel 316	3 Windows	2200K	75°	0.4W	4	10	2.2W	16	7	1A D
GL100SS3W27	Stainless steel 316	3 Windows	2700K	75°	0.4W	4	10	2.2W	16	7	1A D
GL100SS3W30	Stainless steel 316	3 Windows	3000K	75°	0.4W	4	10	2.2W	17	8	1A D
GL100SS3W40	Stainless steel 316	3 Windows	4000K	75°	0.4W	5	11	2.2W	19	8	1A D

In the part code to replace your colour change SS (Stainless Steel) to AB (Antique Brass) or BK (Black). **Important:** BK finish is made to order. Energy rating is a reflection of the LED light source.

Wiring information

Cable / flying lead	1m (H05RN-F) rubberised cable (outside diameter: 6mm)
Type of wiring required	Series

Recommended LED drivers

See pages 200 - 203 for complete LED driver offer

Product code	Input	SELV	Dimming	Bathroom zone	Products per driver
DRV150700 (all settings)	220-240V	Yes	No	N/A	1-13
DRV350700TD (350 & 500mA)	220-240V	Yes	Yes	N/A	3-12
DRV350700TD (700mA)	220-240V	Yes	Yes	N/A	3-8

Accessories

JB2 / JB4 / JB6	IP68 waterproof connectors	Sold Separately	212
WCR 275 BLACK	2-core rubber cable	Sold Separately	213

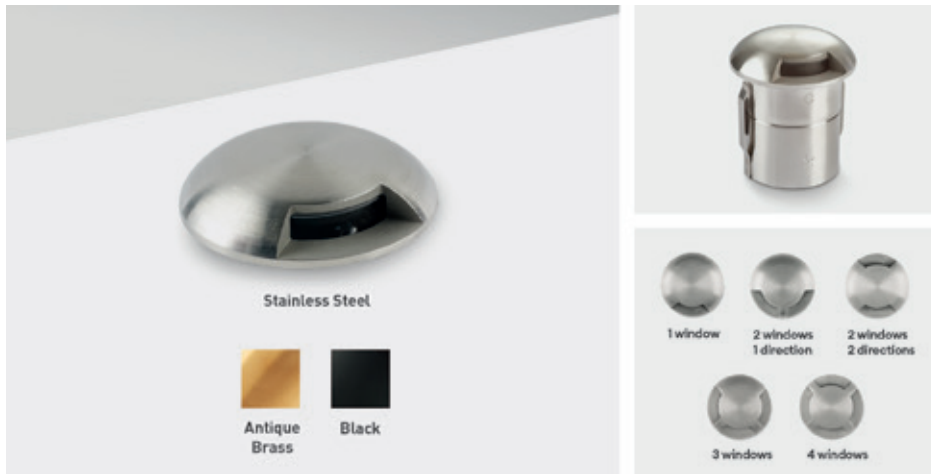

GL100 4 windows

Domed Ground Light

Features

IK rating	IK07
IP rating	IP68
CSP switchable	Single CCT
Walk over / Drive over	Walk over (Stainless Steel & Antique Brass Only)
Input	150mA / 250mA / 350mA / 500mA / 700mA
LED lifetime	L70 70,000h
Colour rendering Index	CRI>80
Colour consistency	SDCM3

Installation information

Cut out size (mm)	33
Bathroom zone	0
Inrush current	N/A
Construction material	Stainless Steel
Suitable for coastal areas	Yes
Weight	GL100AB: 221g, GL100BK: TBC, GL100SS: 212g
Maximum ambient temperature	55°C
SELV	N/A
Electric class (1, 2, 3)	3
Earth leakage	N/A

Photometrics @ 25°C

Product code	Finish	Window	CCT	Beam angle	150mA			700mA			Energy
					W	lm	lm/W	W	lm	lm/W	
GL100SS4W22	Stainless steel 316	4 Windows	2200K	75°	0.4W	5	11	2.2W	18	8	11 D
GL100SS4W27	Stainless steel 316	4 Windows	2700K	75°	0.4W	5	11	2.2W	18	8	11 D
GL100SS4W30	Stainless steel 316	4 Windows	3000K	75°	0.4W	5	12	2.2W	20	9	11 D
GL100SS4W40	Stainless steel 316	4 Windows	4000K	75°	0.4W	6	13	2.2W	22	10	11 D

In the part code to replace your colour change SS (Stainless Steel) to AB (Antique Brass) or BK (Black). **Important:** BK finish is made to order. Energy rating is a reflection of the LED light source.

Wiring information

Cable / flying lead	1m (H05RN-F) rubberised cable (outside diameter: 6mm)
Type of wiring required	Series

Recommended LED drivers

See pages 200 - 203 for complete LED driver offer

Product code	Input	SELV	Dimming	Bathroom zone	Products per driver
DRV150700 (all settings)	220-240V	Yes	No	N/A	1-13
DRV350700TD (350 & 500mA)	220-240V	Yes	Yes	N/A	3-12
DRV350700TD (700mA)	220-240V	Yes	Yes	N/A	3-8

Accessories

JB2 / JB4 / JB6	IP68 waterproof connectors	Sold Separately	212
WCR 275 BLACK	2-core rubber cable	Sold Separately	213

Ground Lights

IP68 IP68 perfect for internal or external applications

 Coastal protected

IK07 IK07 impact protection - walk over (Stainless Steel only)

Guarantee

7 years

Features & benefits

Supplied complete with installation tube

Low voltage ground light

Walk over ground light ideal for paths or steps

SDCM3 ensuring uniform light appearance and consistency

CRI 80 providing true colour appearance

Available in a new 2200K setting to create a warm and cosy environment with minimal disruption to natural habitat

Long-lifetime of 70,000hrs

Available in an array of colours

Beam angle: 75°

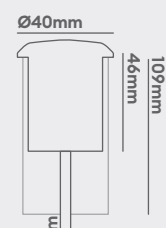
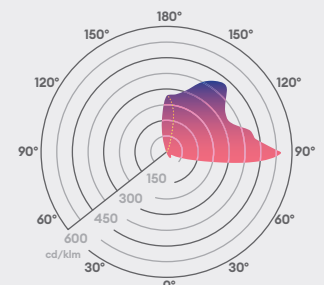





GL200 (1-2 Windows)

5.7W, 40lm, domed ground light

Features

IK rating	IK10
IP rating	IP65
CSP switchable	Single CCT
Walk over / Drive over	Walk over (Stainless Steel & Antique Brass Only)
Input	220-240V AC
LED lifetime	L70 70,000h
Colour rendering index	CRI>80
Colour consistency	SDCM3

Installation information

Cut out size (mm)	70
Bathroom zone	2
Inrush current	31A 0.12ms
Construction material	Stainless steel (316)
Suitable for coastal areas	Yes
Weight	960g
Maximum ambient temperature	35°C
SELV	Yes
Electric class (1, 2, 3)	1
Earth leakage	0.1mA

Photometrics @ 25°C

Product code	Finish	Window	W	CCT	∠°	lm	lm/W	Energy
GL200DX1X27	Stainless steel 316	1 Window	5.7W	2700K	90°	10	2	
GL200DX1X30	Stainless steel 316	1 Window	5.7W	3000K	90°	10	2	
GL200DX1X40	Stainless steel 316	1 Window	5.7W	4000K	90°	10	2	
GL200DX2127	Stainless steel 316	2 Windows 1 Direction	5.7W	2700K	90°	20	4	
GL200DX2130	Stainless steel 316	2 Windows 1 Direction	5.7W	3000K	90°	20	4	
GL200DX2140	Stainless steel 316	2 Windows 1 Direction	5.7W	4000K	90°	20	4	
GL200DX2227	Stainless steel 316	2 Windows 2 Directions	5.7W	2700K	90°	20	4	
GL200DX2230	Stainless steel 316	2 Windows 2 Directions	5.7W	3000K	90°	20	4	
GL200DX2240	Stainless steel 316	2 Windows 2 Directions	5.7W	4000K	90°	20	4	

Energy rating is a reflection of the LED light source.

Wiring information

Cable / flying lead	3m H05RN-F rubberised cable (outside diameter: 7mm)
Type of wiring required	Parallel

Accessories

JB5	Gell filled waterproof connector	Sold Separately	212
TUBE/68	Installation tube	Sold Separately	60
WC 5-9	Quick waterproof connector	Sold Separately	212

Ground Lights

5.7W 5.7W



Coastal protected



Straight to mains ground light

Guarantee

7 years

Features & benefits

Marine grade stainless steel 316 or antique brass

5 window styles and colour temperatures to suit any installation

Beam angle: 90°

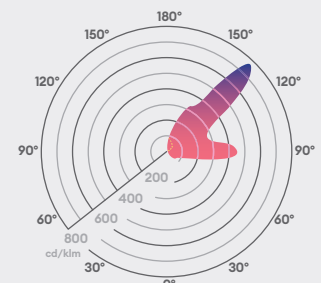

Ø76mm

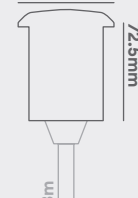

Ground Lights

5.7W 5.7W



Coastal protected



Straight to mains ground light

Guarantee

7 years

Features & benefits

Marine grade stainless steel 316 or antique brass

5 window styles and colour temperatures to suit any installation



GL200 (3-4 Windows)

5.7W, 40lm, domed ground light

Features

IK rating	IK10
IP rating	IP65
CSP switchable	Single CCT
Walk over / Drive over	Walk over (Stainless Steel & Antique Brass Only)
Input	220-240V AC
LED lifetime	L70 70,000h
Colour rendering index	CRI>80
Colour consistency	SDCM3

Installation information

Cut out size (mm)	70
Bathroom zone	2
Inrush current	31A 0.12ms
Construction material	Stainless steel (316)
Suitable for coastal areas	Yes
Weight	940g
Maximum ambient temperature	35°C
SELV	Yes
Electric class (1, 2, 3)	1
Earth leakage	0.1mA

Photometrics @ 25°C

Product code	Finish	Window	W	CCT	∠	lm	lm/W	Energy
GL200DX3X27	Stainless steel 316	3 Windows	5.7W	2700K	90°	30	5	E
GL200DX3X30	Stainless steel 316	3 Windows	5.7W	3000K	90°	30	5	E
GL200DX4X27	Stainless steel 316	4 Windows	5.7W	2700K	90°	40	7	E
GL200DX4X30	Stainless steel 316	4 Windows	5.7W	3000K	90°	40	7	E
GL200DX4X40	Stainless steel 316	4 Windows	5.7W	4000K	90°	40	7	D

Energy rating is a reflection of the LED light source.

Beam angle: 90°

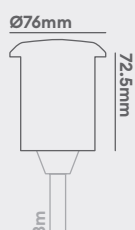
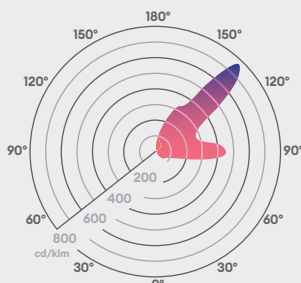



Ground Lights

5.7W 5.7W



Coastal protected



Straight to mains ground light

Guarantee

7 years

Features & benefits

Marine grade stainless steel 316 or antique brass

5 window styles and colour temperatures to suit any installation



GL200 (1-2 Windows)

5.7W, 40lm, domed ground light

Features

IK rating	IK10
IP rating	IP65
CSP switchable	Single CCT
Walk over / Drive over	Walk over (Stainless Steel & Antique Brass Only)
Input	220-240V AC
LED lifetime	L70 70,000h
Colour rendering index	CRI>80
Colour consistency	SDCM3

Installation information

Cut out size (mm)	70
Bathroom zone	2
Inrush current	31A 0.12ms
Construction material	Brass
Suitable for coastal areas	Yes
Weight	1060g
Maximum ambient temperature	35°C
SELV	Yes
Electric class (1, 2, 3)	1
Earth leakage	0.1mA

Photometrics @ 25°C

Product code	Finish	Window	W	CCT	∠	lm	lm/W	Energy
GL200AX1X30	Antique brass	1 Window	5.7W	3000K	90°	10	2	
GL200AX2130	Antique brass	2 Windows 1 Direction	5.7W	3000K	90°	20	4	
GL200AX2230	Antique brass	2 Windows 2 Direction	5.7W	3000K	90°	20	4	

Energy rating is a reflection of the LED light source.

Wiring information

Cable / flying lead	3m H05RN-F rubberised cable (outside diameter: 7mm)
Type of wiring required	Parallel

Accessories

JB5	Gell filled waterproof connector	Sold Separately	212
TUBE/68	Installation tube	Sold Separately	60
WC 5-9	Quick waterproof connector	Sold Separately	212

Beam angle: 90°

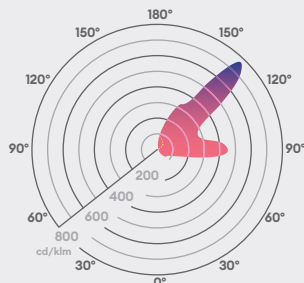

Ø76mm

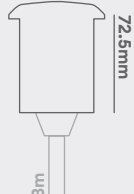



GL200 (3-4 Windows)

5.7W, 40lm, domed ground light

Features

IK rating	IK10
IP rating	IP65
CSP switchable	Single CCT
Walk over / Drive over	Walk over (Stainless Steel & Antique Brass Only)
Input	220-240V AC
LED lifetime	L70 70,000h
Colour rendering index	CRI>80
Colour consistency	SDCM3

Installation information

Cut out size (mm)	70
Bathroom zone	2
Inrush current	31A 0.12ms
Construction material	Brass
Suitable for coastal areas	Yes
Weight	1060g
Maximum ambient temperature	35°C
SELV	Yes
Electric class (1, 2, 3)	1
Earth leakage	0.1mA

Photometrics @ 25°C

Product code	Finish	Window	W	CCT	∠	lm	lm/W	Energy
GL200AX3X30	Antique brass	3 Windows	5.7W	3000K	90°	30	5	
GL200AX4X30	Antique brass	4 Windows	5.7W	3000K	90°	40	7	

Energy rating is a reflection of the LED light source.

Wiring information

Cable / flying lead	3m H05RN-F rubberised cable (outside diameter: 7mm)
Type of wiring required	Parallel

Accessories

JB5	Gell filled waterproof connector	Sold Separately	212
TUBE/68	Installation tube	Sold Separately	60
WC 5-9	Quick waterproof connector	Sold Separately	212

Ground Lights

5.7W 5.7W



Coastal protected



Straight to mains ground light

Guarantee

7 years

Features & benefits

Marine grade stainless steel 316 or antique brass

5 window styles and colour temperatures to suit any installation

Beam angle: 90°

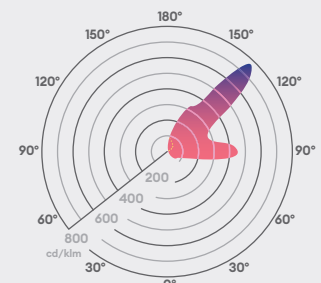

Ø76mm

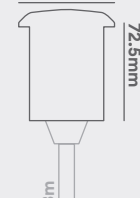





GL016 Round

Low Voltage Ground Light

Features

IK rating	IK09
IP rating	IP68
CSP switchable	Single CCT
Walk over / Drive over	Walk over (Stainless Steel & Antique Brass Only)
Input	150mA / 250mA / 350mA / 500mA / 700mA
LED lifetime	L70 70,000h
Colour rendering Index	CRI>80
Colour consistency	SDCM3

Installation information

Cut out size (mm)	50mm
Bathroom zone	0
Inrush current	N/A
Construction material	Stainless Steel
Suitable for coastal areas	Yes
Weight	GL016AB: TBC, GL016BK: 180g, GL016SS: 400g
Maximum ambient temperature	55°C
SELV	Yes
Electric class (1, 2, 3)	3
Earth leakage	N/A

Photometrics @ 25°C

Product code	Finish	CCT	Beam angle	150mA			700mA			Energy
				W	lm	lm/W	W	lm	lm/W	
GL016RSS22F	Stainless steel 316	2200K	40°	0.4W	51	120	2.2W	196	89	
GL016RSS22S	Stainless steel 316	2200K	12°	0.4W	51	120	2.2W	196	89	
GL016RSS27F	Stainless steel 316	2700K	40°	0.4W	51	120	2.2W	169	89	
GL016RSS27S	Stainless steel 316	2700K	12°	0.4W	51	120	2.2W	169	89	
GL016RSS30F	Stainless steel 316	3000K	40°	0.4W	54	129	2.2W	210	95	
GL016RSS30S	Stainless steel 316	3000K	12°	0.4W	54	129	2.2W	210	95	
GL016RSS40F	Stainless steel 316	4000K	40°	0.4W	60	143	2.2W	234	106	
GL016RSS40S	Stainless steel 316	4000K	12°	0.4W	60	143	2.2W	234	106	

In the part code to replace your colour, change SS (Stainless Steel) to AB (Antique Brass) or BK (Black).
Energy rating is a reflection of the LED light source.

Wiring information

Cable / flying lead	1m (H05RN-F) rubberised cable (outside diameter: 6mm)
Type of wiring required	Series

Recommended LED drivers

See pages 200 - 203 for complete LED driver offer

Product code	Input	SELV	Dimming	Bathroom zone	Products per driver
DRV150700 (all settings)	220-240V	Yes	No	N/A	1-13
DRV350700TD (350 & 500mA)	220-240V	Yes	Yes	N/A	3-12
DRV350700TD (700mA)	220-240V	Yes	Yes	N/A	3-8

Accessories

JB2 / JB4 / JB6	IP68 waterproof connectors	Sold Separately	212
WCR 275 BLACK	2-core rubber cable	Sold Separately	213

Ground Lights

IP68 IP68 perfect for internal or external applications

Coastal protected

IK09 IK09 impact protection - walk over (Stainless Steel only)

Guarantee

7 years

Features & benefits

Supplied complete with installation tube

SDCM3 ensuring uniform light appearance and consistency

CRI 80 providing true colour appearance

Available in a new 2200K setting to create a warm and cosy environment with minimal disruption to natural habitat

Robust cable for outdoor use

Shallow depth for easy installation

Available in an array of colours

Beam angle: 40° 12°

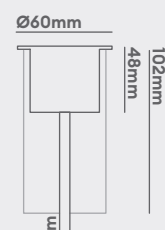
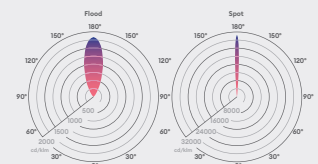

Ground Lights

IP68 IP68 perfect for internal or external applications

 Coastal protected

IK09 IK09 impact protection - walk over (Stainless Steel only)

Guarantee

7 years

Features & benefits

Supplied complete with installation tube

SDCM3 ensuring uniform light appearance and consistency

CRI 80 providing true colour appearance

Available in a new 2200K setting to create a warm and cosy environment with minimal disruption to natural habitat



GL016 Frosted

Low Voltage Ground Light





Features

IK rating	IK09
IP rating	IP68
CSP switchable	Single CCT
Walk over / Drive over	Walk over (Stainless Steel & Antique Brass Only)
Input	150mA / 250mA / 350mA
LED lifetime	L70 70,000h
Colour rendering index	CRI>80
Colour consistency	SDCM3

Installation information

Cut out size (mm)	50mm
Bathroom zone	0
Inrush current	N/A
Construction material	Stainless Steel
Suitable for coastal areas	Yes
Weight	GL016AB: TBC, GL016BK: 180g, GL016SS: 400g
Maximum ambient temperature	55°C
SELV	Yes
Electric class (1, 2, 3)	3
Earth leakage	N/A

Photometrics @ 25°C

Product code	Finish	CCT	Beam angle	150mA			350mA			Energy
				W	lm	lm/W	W	lm	lm/W	
GL016SSF22	Stainless steel 316	2200K	100°	0.4W	12	29	1W	25	25	
GL016SSF27	Stainless steel 316	2700K	100°	0.4W	14	35	1W	30	30	
GL016SSF30	Stainless steel 316	3000K	100°	0.4W	14	35	1W	30	30	
GL016SSF40	Stainless steel 316	4000K	100°	0.4W	14	35	1W	30	30	

In the part code to replace your colour change SS (Stainless Steel) to AB (Antique Brass) or BK (Black). **Important:** AB finish is made to order. Energy rating is a reflection of the LED light source.

Wiring information

Cable / flying lead	1m (H05RN-F) rubberised cable (outside diameter: 6mm)
Type of wiring required	Series

Recommended LED drivers

See pages 200 - 203 for complete LED driver offer

Product code	Input	SELV	Dimming	Bathroom zone	Products per driver
DRV150700 (150-350mA)	220-240V	Yes	No	N/A	1-13
DRV350700TD (350mA)	220-240V	Yes	Yes	N/A	3-12
PSIP35018W	220-240V	Yes	No	1	9-17

Accessories

JB2 / JB4 / JB6	IP68 waterproof connectors	Sold Separately	212
WCR 275 BLACK	2-core rubber cable	Sold Separately	213

Beam angle: 100°

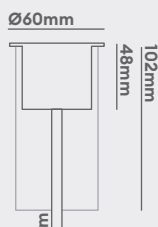
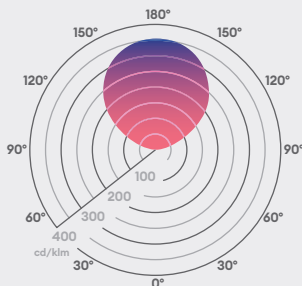



Ground Lights

IP68

IP68 perfect for internal or external applications



Coastal protected

IK09

IK09 impact protection - walk over (Stainless Steel only)

Guarantee

7 years

Features & benefits

Supplied complete with installation tube

SDCM3 ensuring uniform light appearance and consistency

CRI 80 providing true colour appearance

Available in a new 2200K setting to create a warm and cosy environment with minimal disruption to natural habitat

Robust cable for outdoor use

Shallow depth for easy installation

Available in an array of colours

Beam angle: 30° 8°

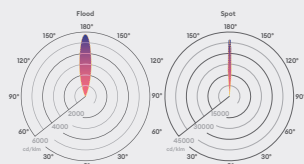

Ø60mm

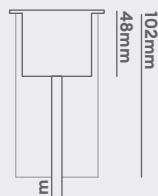

GL016 Low Glare

Low Voltage Ground Light

Features

IK rating	IK09
IP rating	IP68
CSP switchable	Single CCT
Walk over / Drive over	Walk over (Stainless Steel & Antique Brass Only)
Input	150mA / 250mA / 350mA / 500mA / 700mA
LED lifetime	L70 70,000h
Colour rendering Index	CRI>80
Colour consistency	SDCM3

Installation information

Cut out size (mm)	50mm
Bathroom zone	0
Inrush current	N/A
Construction material	Stainless Steel
Suitable for coastal areas	Yes
Weight	GL016AB: TBC, GL016BK: 180g, GL016SS: 400g
Maximum ambient temperature	55°C
SELV	Yes
Electric class (1, 2, 3)	3
Earth leakage	N/A

Photometrics @ 25°C

Product code	Finish	CCT	Beam angle	150mA			700mA			Energy
				W	lm	lm/W	W	lm	lm/W	
GL016SSLG22F	Stainless steel 316	2200K	30°	0.4W	31	74	2.2W	120	55	LED
GL016SSLG22S	Stainless steel 316	2200K	8°	0.4W	31	74	2.2W	120	55	LED
GL016SSLG27F	Stainless steel 316	2700K	30°	0.4W	31	74	2.2W	120	55	LED
GL016SSLG27S	Stainless steel 316	2700K	8°	0.4W	31	74	2.2W	120	55	LED
GL016SSLG30F	Stainless steel 316	3000K	30°	0.4W	33	79	2.2W	128	58	LED
GL016SSLG30S	Stainless steel 316	3000K	8°	0.4W	33	79	2.2W	128	58	LED
GL016SSLG40F	Stainless steel 316	4000K	30°	0.4W	37	87	2.2W	143	65	LED
GL016SSLG40S	Stainless steel 316	4000K	8°	0.4W	37	87	2.2W	143	65	LED

In the part code to replace your colour, change SS (Stainless Steel) to AB (Antique Brass) or BK (Black). Energy rating is a reflection of the LED light source.

Wiring information

Cable / flying lead	1m (H05RN-F) rubberised cable (outside diameter: 6mm)
Type of wiring required	Series

Recommended LED drivers

See pages 200 - 203 for complete LED driver offer

Product code	Input	SELV	Dimming	Bathroom zone	Products per driver
DRV150700 (all settings)	220-240V	Yes	No	N/A	1-13
DRV350700TD (350 & 500mA)	220-240V	Yes	Yes	N/A	3-12
DRV350700TD (700mA)	220-240V	Yes	Yes	N/A	3-8

Accessories

JB2 / JB4 / JB6	IP68 waterproof connectors	Sold Separately	212
WCR 275 BLACK	2-core rubber cable	Sold Separately	213



GL016 Ultra Low Glare

Low Voltage Ground Light

Features

IK rating	IK09
IP rating	IP68
CSP switchable	Single CCT
Walk over / Drive over	Walk over (Stainless Steel & Antique Brass Only)
Input	150mA / 250mA / 350mA
LED lifetime	L70 70,000h
Colour rendering index	CRI>80
Colour consistency	SDCM3

Installation information

Cut out size (mm)	50mm
Bathroom zone	0
Inrush current	N/A
Construction material	Stainless Steel
Suitable for coastal areas	Yes
Weight	GL016AB: TBC, GL016BK: 180g, GL016SS: 400g
Maximum ambient temperature	55°C
SELV	Yes
Electric class (1, 2, 3)	3
Earth leakage	N/A

Photometrics @ 25°C

Product code	Finish	CCT	Beam angle	150mA			350mA			Energy
				W	lm	lm/W	W	lm	lm/W	
GL016USS22F	Stainless steel 316	2200K	34°	0.4W	51	120	1W	109	109	1 D
GL016USS27F	Stainless steel 316	2700K	34°	0.4W	51	120	1W	109	109	1 D
GL016USS30F	Stainless steel 316	3000K	34°	0.4W	54	129	1W	116	116	1 D
GL016USS40F	Stainless steel 316	4000K	34°	0.4W	60	143	1W	129	129	1 D

In the part code to replace your colour change SS (Stainless Steel) to AB (Antique Brass) or BK (Black). **Important:** All finishes are made to order. Energy rating is a reflection of the LED light source.

Wiring information

Cable / flying lead	1m (H05RN-F) rubberised cable (outside diameter: 6mm)
Type of wiring required	Series

Recommended LED drivers

See pages 200 - 203 for complete LED driver offer

Product code	Input	SELV	Dimming	Bathroom zone	Products per driver
DRV150700 (all settings)	220-240V	Yes	No	N/A	1-13
DRV350700TD (350mA)	220-240V	Yes	Yes	N/A	3-12
PSIP35018W	220-240V	Yes	No	1	8-16

Accessories

JB2 / JB4 / JB6	IP68 waterproof connectors	Sold Separately	212
WCR 275 BLACK	2-core rubber cable	Sold Separately	213

Ground Lights

IP68 IP68 perfect for internal or external applications

 Coastal protected

IK09 IK09 impact protection - walk over (Stainless Steel only)

Guarantee

7 years

Features & benefits

Supplied complete with installation tube

SDCM3 ensuring uniform light appearance and consistency

CRI 80 providing true colour appearance

Available in a new 2200K setting to create a warm and cosy environment with minimal disruption to natural habitat

Robust cable for outdoor use

Shallow depth for easy installation

Available in an array of colours

Beam angle: 34°

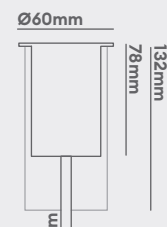
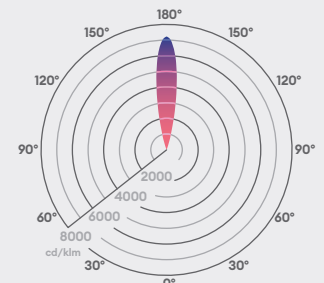

Ground Lights

IP68 IP68 perfect for internal or external applications

Coastal protected

IK09 IK09 impact protection - walk over (Stainless Steel only)

Guarantee

7 years

Features & benefits

Supplied complete with installation tube

SDCM3 ensuring uniform light appearance and consistency

CRI 80 providing true colour appearance

Available in a new 2200K setting to create a warm and cosy environment with minimal disruption to natural habitat

Robust cable for outdoor use

Shallow depth for easy installation

Available in an array of colours

Beam angle: 20°

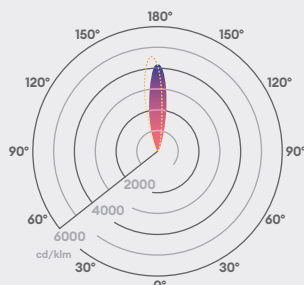

Ø60mm

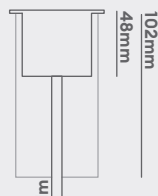

GL016 Half Moon

Low Voltage Ground Light

Features

IK rating	IK09
IP rating	IP68
CSP switchable	Single CCT
Walk over / Drive over	Walk over (Stainless Steel & Antique Brass Only)
Input	150mA / 250mA / 350mA / 500mA / 700mA
LED lifetime	L70 70,000h
Colour rendering Index	CRI>80
Colour consistency	SDCM3

Installation information

Cut out size (mm)	50mm
Bathroom zone	0
Inrush current	N/A
Construction material	Stainless Steel
Suitable for coastal areas	Yes
Weight	GL016AB: TBC, GL016BK: 180g, GL016SS: 400g
Maximum ambient temperature	55°C
SELV	Yes
Electric class (1, 2, 3)	3
Earth leakage	N/A

Photometrics @ 25°C

Product code	Finish	CCT	Beam angle	150mA			700mA			Energy
				W	lm	lm/W	W	lm	lm/W	
GL016SSHM22	Stainless steel 316	2200K	20°	0.4W	19	46	2.2W	75	38	1 D
GL016SSHM27	Stainless steel 316	2700K	20°	0.4W	19	46	2.2W	75	38	1 D
GL016SSHM30	Stainless steel 316	3000K	20°	0.4W	21	49	2.2W	80	36	1 D
GL016SSHM40	Stainless steel 316	4000K	20°	0.4W	23	54	2.2W	89	40	1 D

In the part code to replace your colour change SS (Stainless Steel) to AB (Antique Brass) or BK (Black). **Important:** All finishes are made to order. Energy rating is a reflection of the LED light source.

Wiring information

Cable / flying lead	1m (H05RN-F) rubberised cable (outside diameter: 6mm)
Type of wiring required	Series

Recommended LED drivers

See pages 200 - 203 for complete LED driver offer

Product code	Input	SELV	Dimming	Bathroom zone	Products per driver
DRV150700 (all settings)	220-240V	Yes	No	N/A	1-13
DRV350700TD (350 & 500mA)	220-240V	Yes	Yes	N/A	3-12
DRV350700TD (700mA)	220-240V	Yes	Yes	N/A	3-8

Accessories

JB2 / JB4 / JB6	IP68 waterproof connectors	Sold Separately	212
WCR 275 BLACK	2-core rubber cable	Sold Separately	213



GL016 Square

Low Voltage Ground Light

Features

IK rating	IK09
IP rating	IP68
CSP switchable	Single CCT
Walk over / Drive over	Walk over (Stainless Steel & Antique Brass Only)
Input	150mA / 250mA / 350mA / 500mA / 700mA
LED lifetime	L70 70,000h
Colour rendering Index	CRI>80
Colour consistency	SDCM3

Installation information

Cut out size (mm)	50mm
Bathroom zone	0
Inrush current	N/A
Construction material	Stainless Steel
Suitable for coastal areas	Yes
Weight	GL016AB: TBC, GL016BK: 180g, GL016SS: 400g
Maximum ambient temperature	55°C
SELV	Yes
Electric class (1, 2, 3)	3
Earth leakage	N/A

Photometrics @ 25°C

Product code	Finish	CCT	Beam angle	150mA			700mA			Energy
				W	lm	lm/W	W	lm	lm/W	
GL016SQSS27F	Stainless steel 316	2200K	40°	0.4W	51	120	2.2W	196	89	
GL016SQSS30F	Stainless steel 316	2200K	40°	0.4W	51	129	2.2W	196	95	
GL016SQSS40F	Stainless steel 316	2200K	40°	0.4W	51	143	2.2W	196	106	

In the part code to replace your colour, change SS (Stainless Steel) to AB (Antique Brass) or BK (Black). **Important:** BK & AB finish are made to order. Energy rating is a reflection of the LED light source.

Wiring information

Cable / flying lead	1m (H05RN-F) rubberised cable (outside diameter: 6mm)
Type of wiring required	Series

Recommended LED drivers

See pages 200 - 203 for complete LED driver offer

Product code	Input	SELV	Dimming	Bathroom zone	Products per driver
DRV150700 (all settings)	220-240V	Yes	No	N/A	1-13
DRV350700TD (350 & 500mA)	220-240V	Yes	Yes	N/A	3-12
DRV350700TD (700mA)	220-240V	Yes	Yes	N/A	3-8

Accessories

JB2 / JB4 / JB6	IP68 waterproof connectors	Sold Separately	212
WCR 275 BLACK	2-core rubber cable	Sold Separately	213

Ground Lights

IP68 IP68 perfect for internal or external applications

Coastal protected

IK09 IK09 impact protection - walk over (Stainless Steel only)

Guarantee

7 years

Features & benefits

Supplied complete with installation tube

SDCM3 ensuring uniform light appearance and consistency

CRI 80 providing true colour appearance

Available in a new 2200K setting to create a warm and cosy environment with minimal disruption to natural habitat

Robust cable for outdoor use

Shallow depth for easy installation

Available in an array of colours

Beam angle: 40°

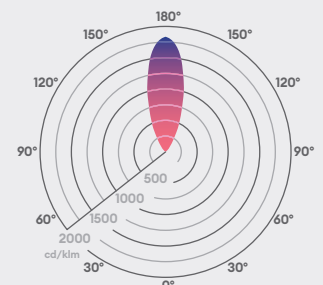

60x60mm

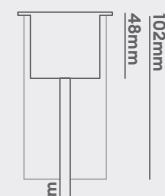

Ground Lights

IP68

IP65 perfect for internal or external applications



Coastal protected

IK08

IK08 impact protection - walk over (Stainless Steel only)

Guarantee

7 years

Features & benefits

Supplied complete with installation tube

SDCM3 ensuring uniform light appearance and consistency

Single LED and lens combination for maximum efficiency and optimal light distribution

CRI 80 providing true colour appearance

Available in a new 2200K setting to create a warm and cosy environment with minimal disruption to natural habitat

Long lifetime of 70,000hrs

Available in an array of colours

Beam angle: 40° 12°

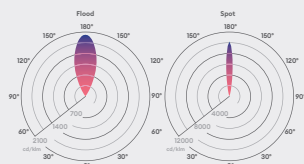

Ø76mm

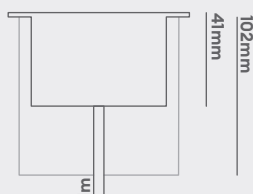

GL040 Round

Modular Ground Light

Features

IK rating	IK08
IP rating	IP68
CSP switchable	Single CCT
Walk over / Drive over	Walk over (Stainless Steel & Antique Brass Only)
Input	150mA / 250mA / 350mA / 500mA / 700mA
LED lifetime	L70 70,000h
Colour rendering Index	CRI>80
Colour consistency	SDCM3

Installation information

Cut out size (mm)	70mm
Bathroom zone	0
Inrush current	N/A
Construction material	Stainless Steel
Suitable for coastal areas	Yes
Weight	GL040AB: 600g, GL040BK: TBC, GL040SS: 720g
Maximum ambient temperature	55°C
SELV	N/A
Electric class (1, 2, 3)	3
Earth leakage	N/A

Photometrics @ 25°C

Product code	Finish	CCT	Beam angle	150mA			700mA			Energy
				W	lm	lm/W	W	lm	lm/W	
GL040RSS22F	Stainless steel 316	2200K	40°	0.8W	108	135	4.6W	431	94	1 E
GL040RSS22S	Stainless steel 316	2200K	12°	0.8W	108	135	4.6W	431	94	1 E
GL040RSS27F	Stainless steel 316	2700K	40°	0.8W	129	161	4.6W	515	112	1 E
GL040RSS27S	Stainless steel 316	2700K	12°	0.8W	129	161	4.6W	515	112	1 E
GL040RSS30F	Stainless steel 316	3000K	40°	0.8W	130	163	4.6W	520	113	1 E
GL040RSS30S	Stainless steel 316	3000K	12°	0.8W	130	163	4.6W	520	113	1 E
GL040RSS40F	Stainless steel 316	4000K	40°	0.8W	134	168	4.6W	538	117	1 E
GL040RSS40S	Stainless steel 316	4000K	12°	0.8W	134	168	4.6W	538	117	1 E

In the part code to replace your colour change SS (Stainless Steel) to AB (Antique Brass) or BK (Black). **Important:** BK finish is made to order. Energy rating is a reflection of the LED light source.

Wiring information

Cable / flying lead	1m (H05RN-F) rubberised cable (outside diameter: 6mm)
Type of wiring required	Series

Recommended LED drivers

See pages 200 - 203 for complete LED driver offer

Product code	Input	SELV	Dimming	Bathroom zone	Products per driver
DRV150700 (all settings)	220-240V	Yes	No	N/A	1-6
DRV350700TD (700mA)	220-240V	Yes	Yes	N/A	2-4
PSMD70024	220-240V	Yes	Yes	N/A	1-2

Accessories

JB2 / JB4 / JB6	IP68 waterproof connectors	Sold Separately	212
WCR 275 BLACK	2-core rubber cable	Sold Separately	213



GL040 Frosted

Modular Ground Light

Features

IK rating	IK08
IP rating	IP68
CSP switchable	Single CCT
Walk over / Drive over	Walk over (Stainless Steel & Antique Brass Only)
Input	150mA / 250mA / 350mA
LED lifetime	L70 70,000h
Colour rendering index	CRI>80
Colour consistency	SDCM3

Installation information

Cut out size (mm)	70mm
Bathroom zone	1
Inrush current	N/A
Construction material	Stainless Steel
Suitable for coastal areas	Yes
Weight	GL040AB: 600g, GL040BK: TBC, GL040SS: 720g
Maximum ambient temperature	55°C
SELV	N/A
Electric class (1, 2, 3)	3
Earth leakage	N/A

Photometrics @ 25°C

Product code	Finish	CCT	Beam angle	150mA			350mA			Energy
				W	lm	lm/W	W	lm	lm/W	
GL040SSF22	Stainless steel 316	2200K	100°	0.4W	19	48	1W	45	45	A B C
GL040SSF27	Stainless steel 316	2700K	100°	0.4W	23	57	1W	56	56	A B C
GL040SSF30	Stainless steel 316	3000K	100°	0.4W	23	58	1W	56	56	A B C
GL040SSF40	Stainless steel 316	4000K	100°	0.4W	24	59	1W	56	56	A B C

In the part code to replace your colour change SS (Stainless Steel) to AB (Antique Brass) or BK (Black). **Important:** All finishes are made to order. Energy rating is a reflection of the LED light source.

Wiring information

Cable / flying lead	1m (H05RN-F) rubberised cable (outside diameter: 6mm)
Type of wiring required	Series

Recommended LED drivers

See pages 200 - 203 for complete LED driver offer

Product code	Input	SELV	Dimming	Bathroom zone	Products per driver
DRV150700 (150-350mA)	220-240V	Yes	No	N/A	1-13
DRV350700TD (350mA)	220-240V	Yes	Yes	N/A	3-12
PSIP35018W	220-240V	Yes	No	1	8-15

Accessories

JB2 / JB4 / JB6	IP68 waterproof connectors	Sold Separately	212
WCR 275 BLACK	2-core rubber cable	Sold Separately	213

Ground Lights

IP68 IP65 perfect for internal or external applications

 Coastal protected

IK08 IK08 impact protection - walk over (Stainless Steel only)

Guarantee

7 years

Features & benefits

Supplied complete with installation tube

SDCM3 ensuring uniform light appearance and consistency

Single LED and lens combination for maximum efficiency and optimal light distribution

CRI 80 providing true colour appearance

Available in a new 2200K setting to create a warm and cosy environment with minimal disruption to natural habitat

Long lifetime of 70,000hrs

Available in an array of colours

Beam angle: 100°

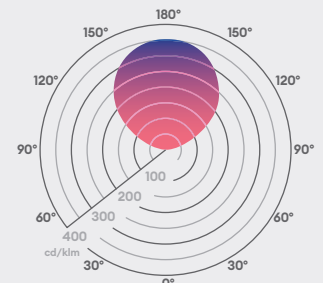

Ø76mm

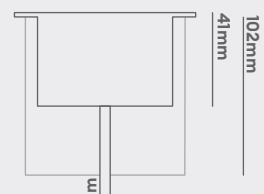

Ground Lights

IP68 IP65 perfect for internal or external applications

 Coastal protected

IK08 IK08 impact protection - walk over (Stainless Steel only)

Guarantee

7 years

Features & benefits

Supplied complete with installation tube

SDCM3 ensuring uniform light appearance and consistency

Single LED and lens combination for maximum efficiency and optimal light distribution

CRI 80 providing true colour appearance

Available in a new 2200K setting to create a warm and cosy environment with minimal disruption to natural habitat

Long lifetime of 70,000hrs

Available in an array of colours

Beam angle: 30° 12°

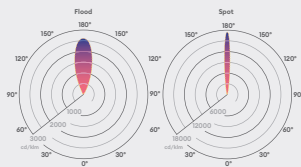

Ø76mm

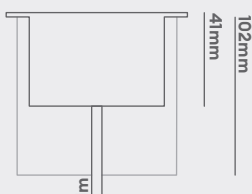

GL040 Low Glare

Modular Ground Light

Features

IK rating	IK08
IP rating	IP68
CSP switchable	Single CCT
Walk over / Drive over	Walk over (Stainless Steel & Antique Brass Only)
Input	150mA / 250mA / 350mA / 500mA / 700mA
LED lifetime	L70 70,000h
Colour rendering Index	CRI>80
Colour consistency	SDCM3

Installation information

Cut out size (mm)	70mm
Bathroom zone	1
Inrush current	N/A
Construction material	Stainless Steel
Suitable for coastal areas	Yes
Weight	GL040AB: 700g, GL040BK: TBC, GL040SS: 818g
Maximum ambient temperature	55°C
SELV	N/A
Electric class (1, 2, 3)	3
Earth leakage	N/A

Photometrics @ 25°C

Product code	Finish	CCT	Beam angle	150mA			700mA			Energy
				W	lm	lm/W	W	lm	lm/W	
GL040SSLG22F	Stainless steel 316	2200K	30°	0.8W	66	82	4.6W	264	57	
GL040SSLG22S	Stainless steel 316	2200K	12°	0.8W	66	82	4.6W	264	57	
GL040SSLG27F	Stainless steel 316	2700K	30°	0.8W	79	98	4.6W	315	68	
GL040SSLG27S	Stainless steel 316	2700K	12°	0.8W	79	98	4.6W	315	68	
GL040SSLG30F	Stainless steel 316	3000K	30°	0.8W	79	99	4.6W	318	69	
GL040SSLG30S	Stainless steel 316	3000K	12°	0.8W	79	99	4.6W	318	69	
GL040SSLG40F	Stainless steel 316	4000K	30°	0.8W	82	103	4.6W	329	71	
GL040SSLG40S	Stainless steel 316	4000K	12°	0.8W	82	103	4.6W	329	71	

In the part code to replace your colour change SS (Stainless Steel) to AB (Antique Brass) or BK (Black). **Important:** All finishes are made to order. Energy rating is a reflection of the LED light source.

Wiring information

Cable / flying lead 1m (H05RN-F) rubberised cable (outside diameter: 6mm)

Type of wiring required Series

Recommended LED drivers

See pages 200 - 203 for complete LED driver offer

Product code	Input	SELV	Dimming	Bathroom zone	Products per driver
DRV150700 (all settings)	220-240V	Yes	No	N/A	1-6
DRV350700TD (700mA)	220-240V	Yes	Yes	N/A	2-4
PSMD70024	220-240V	Yes	Yes	N/A	1-2

Accessories

JB2 / JB4 / JB6	IP68 waterproof connectors	Sold Separately	212
WCR 275 BLACK	2-core rubber cable	Sold Separately	213

Ground Lights

IP68 IP65 perfect for internal or external applications

 Coastal protected

IK08 IK08 impact protection - walk over (Stainless Steel only)

Guarantee

7 years

Features & benefits

Supplied complete with installation tube

SDCM3 ensuring uniform light appearance and consistency

Single LED and lens combination for maximum efficiency and optimal light distribution

CRI 80 providing true colour appearance

Available in a new 2200K setting to create a warm and cosy environment with minimal disruption to natural habitat

Long lifetime of 70,000hrs

Available in an array of colours

Beam angle: 40°

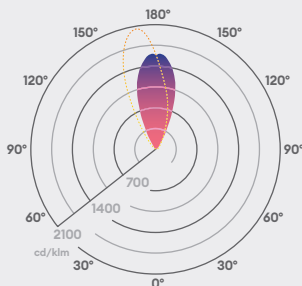

Ø76mm

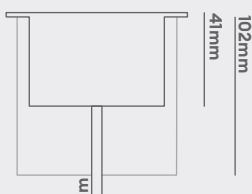

GL040 Half Moon

Modular Ground Light

Features

IK rating	IK08
IP rating	IP68
CSP switchable	Single CCT
Walk over / Drive over	Walk over (Stainless Steel & Antique Brass Only)
Input	150mA / 250mA / 350mA / 500mA / 700mA
LED lifetime	L70 70,000h
Colour rendering Index	CRI>80
Colour consistency	SDCM3

Installation information

Cut out size (mm)	70mm
Bathroom zone	1
Inrush current	N/A
Construction material	Stainless Steel
Suitable for coastal areas	Yes
Weight	GL040AB: 600g, GL040BK: TBC, GL040SS: 720g
Maximum ambient temperature	55°C
SELV	N/A
Electric class (1, 2, 3)	3
Earth leakage	N/A

Photometrics @ 25°C

Product code	Finish	CCT	Beam angle	150mA			700mA			Energy
				W	lm	lm/W	W	lm	lm/W	
GL040SSHM22	Stainless steel 316	2200K	40°	0.8W	37	47	4.6W	149	32	
GL040SSHM27	Stainless steel 316	2700K	40°	0.8W	45	56	4.6W	178	39	
GL040SSHM30	Stainless steel 316	3000K	40°	0.8W	45	56	4.6W	180	39	
GL040SSHM40	Stainless steel 316	4000K	40°	0.8W	47	58	4.6W	186	40	

In the part code to replace your colour change SS (Stainless Steel) to AB (Antique Brass) or BK (Black). **Important:** All finishes are made to order. Energy rating is a reflection of the LED light source.

Wiring information

Cable / flying lead	1m (H05RN-F) rubberised cable (outside diameter: 6mm)
Type of wiring required	Series

Recommended LED drivers

See pages 200 - 203 for complete LED driver offer

Product code	Input	SELV	Dimming	Bathroom zone	Products per driver
DRV150700 (all settings)	220-240V	Yes	No	N/A	1-6
DRV350700TD (700mA)	220-240V	Yes	Yes	N/A	2-4
PSMD70024	220-240V	Yes	Yes	N/A	1-2

Accessories

JB2 / JB4 / JB6	IP68 waterproof connectors	Sold Separately	212
WCR 275 BLACK	2-core rubber cable	Sold Separately	213



Ground Lights

IP65 IP65 perfect for internal or external applications

 Coastal protected

IK08 IK08 impact protection - walk over (Stainless Steel only)

Guarantee

7 years

Features & benefits

Supplied complete with installation tube

SDCM3 ensuring uniform light appearance and consistency

Single LED and lens combination for maximum efficiency and optimal light distribution

CRI 80 providing true colour appearance

Available in a new 2200K setting to create a warm and cosy environment with minimal disruption to natural habitat

Long lifetime of 70,000hrs

Available in an array of colours

Beam angle: 40°

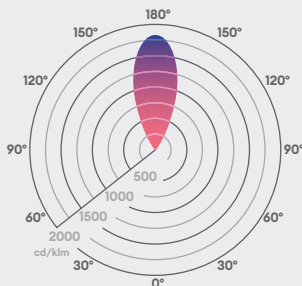

Ø98mm

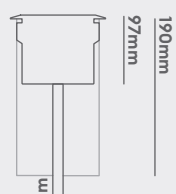

GL038 Low Voltage

Low Voltage LED Ground light





Features

IK rating	IK08
IP rating	IP65
CSP switchable	Single CCT
Walk over / Drive over	Walk over (Stainless Steel & Antique Brass Only)
Input	150mA / 250mA / 350mA / 500mA / 700mA
LED lifetime	L70 70,000h
Colour rendering Index	CRI>80
Colour consistency	SDCM3

Installation information

Cut out size (mm)	80-85mm
Bathroom zone	2
Inrush current	N/A
Construction material	Stainless steel 316
Suitable for coastal areas	Yes
Weight	GL038AB: 754g, GL038BK: TBC, GL038SS: 696g, GL038BZ: TBC
Maximum ambient temperature	35°C
SELV	Yes
Electric class (1, 2, 3)	1
Earth leakage	N/A

Photometrics @ 25°C

Product code	Finish	CCT	Beam angle	150mA			700mA			Energy
				W	lm	lm/W	W	lm	lm/W	
GL038SS22XF	Stainless steel 316	2200K	40°	0.8W	108	135	4.6W	431	94	
GL038SS27XF	Stainless steel 316	2700K	40°	0.8W	129	161	4.6W	515	112	
GL038SS30XF	Stainless steel 316	3000K	40°	0.8W	130	163	4.6W	520	113	
GL038SS40XF	Stainless steel 316	4000K	40°	0.8W	134	168	4.6W	538	117	

In the part code to replace your colour, change SS to AB (Antique Brass), BK (Black) or BZ (Bronze). **Important:** BK & BZ finish are made to order. Energy rating is a reflection of the LED light source.

Wiring information

Cable / flying lead	1m H05RN-F rubberised cable (outside diameter: 7mm)
Type of wiring required	Parallel

Recommended LED drivers

See pages 200 - 203 for complete LED driver offer

Product code	Input	SELV	Dimming	Bathroom zone	Products per driver
DRV150700 (all settings)	220-240V	Yes	No	N/A	1-6
DRV350700TD (350 & 500mA)	220-240V	Yes	Yes	N/A	3-12
DRV350700TD (700mA)	220-240V	Yes	Yes	N/A	2-4

Accessories

JB5	Gel filled waterproof connector	Sold Separately	212
WC 5-9	Quick release waterproof joint	Sold Separately	212



GL038 Mains

Straight to mains LED Ground light

Features

IK rating	IK08
IP rating	IP65
CSP switchable	Single CCT
Walk over / Drive over	Walk over (Stainless Steel & Antique Brass Only)
Input	220-240V AC
LED lifetime	L70 70,000h
Colour rendering index	CRI>80
Colour consistency	SDCM3

Installation information

Cut out size (mm)	80-85mm
Bathroom zone	2
Inrush current	GL038AB: 9A 0.8ms, GL038BK: TBC, GL038SS: 60A 0.037ms, GL038BZ: TBC
Construction material	Stainless steel 316
Suitable for coastal areas	Yes
Weight	GL038AB: 754g, GL038BK: TBC, GL038SS: 696g, GL038BZ: TBC
Maximum ambient temperature	35°C
SELV	Yes
Electric class (1, 2, 3)	1
Earth leakage	TBC

Photometrics @ 25°C

Product code	Finish	W	CCT	∠°	lm	lm/W	Energy
GL038SS22MF	Stainless steel 316	2.8W	2200K	40°	249	89	A E
GL038SS27MF	Stainless steel 316	2.8W	2700K	40°	297	106	A E
GL038SS30MF	Stainless steel 316	2.8W	3000K	40°	300	107	A E
GL038SS40MF	Stainless steel 316	2.8W	4000K	40°	310	111	A E

In the part code to replace your colour, change SS to AB (Antique Brass), BK (Black) or BZ (Bronze). **Important:** BK & BZ finish are made to order. Energy rating is a reflection of the LED light source.

Wiring information

Cable / flying lead	1m H05RN-F rubberised cable (outside diameter: 7mm)
Type of wiring required	Parallel

Accessories

JB5	Gel filled waterproof connector	Sold Separately
WC 5-9	Quick release waterproof joint	Sold Separately

Ground Lights

IP65 IP65 perfect for internal or external applications

 Coastal protected

IK08 IK08 impact protection - walk over (Stainless Steel only)

Guarantee

7 years

Features & benefits

Supplied complete with installation tube

SDCM3 ensuring uniform light appearance and consistency

Single LED and lens combination for maximum efficiency and optimal light distribution

CRI 80 providing true colour appearance

Available in a new 2200K setting to create a warm and cosy environment with minimal disruption to natural habitat

Long lifetime of 70,000hrs

Available in an array of colours

Beam angle: 40°

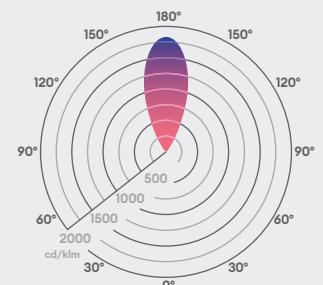

Ø98mm

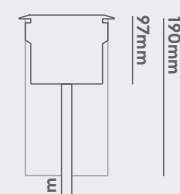

Ground light accessories

Choose the ideal accessory for your ground light

Change the aesthetic or find the perfect way to install your ground light.

Choose the ideal accessory

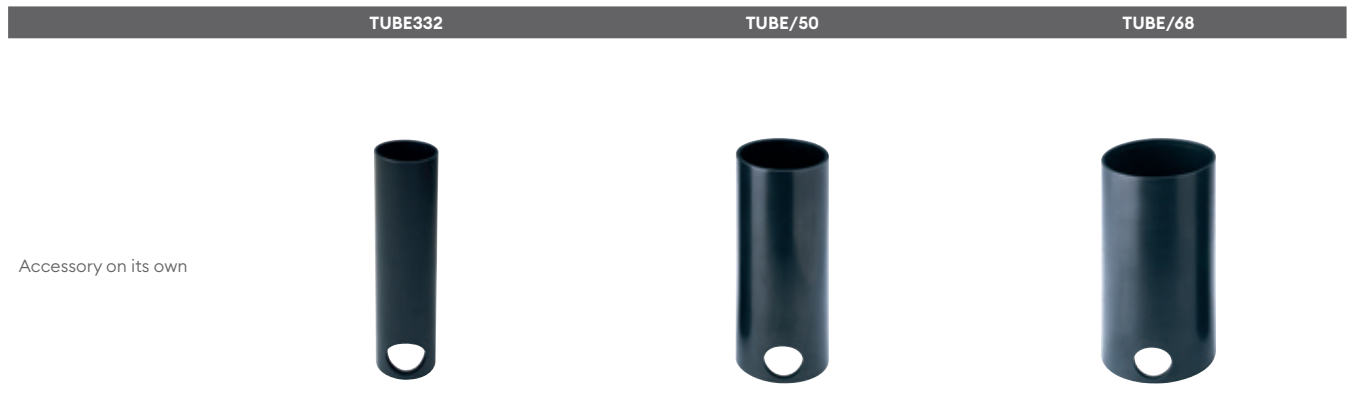

Accessory on its own

Product codes

Product Code	Description	Guarantee
TUBE332	Ground light installation tube	1 year extended warranty
TUBE/50	Ground light installation tube	1 year extended warranty
TUBE/68	Ground light installation tube	1 year extended warranty

For full product specification visit collingwoodlighting.com

Compatible with

	GL200 Page 39-43	GL019 Eyelid Page 66	GL021 Page 70	GL022 Page 71
TUBE332		●		
TUBE/50			●	●
TUBE/68	●			



Tilt Adjustable Ground Light

Straight to Mains, TRIAC mains dimmable

Features

IK rating	GLTM_11: IK08; GLTM_14: IK08; GLTM_16: IK10; GLTM_19: IK10; GLTM_22: IK10
IP rating	IP67
CSP switchable	Single CCT
Walk over / Drive over	Drive over (15mph maximum)
Input	220-240V AC
LED lifetime	L70 50,000h
Colour rendering Index	CRI>80
Colour consistency	SDCM3

Installation information

Cut out size (mm)	119/147/165/193/223
Bathroom zone	2
Inrush current	GLTM_11: 0.5A 0.4ms, GLTM_14: 0.6A 0.4ms, GLTM_16: 0.45A 0.5ms, GLTM_19: 0.55A 0.5ms, GLTM_22: 0.55A 0.5ms
Construction material	Anodised aluminium body, 316 SS bezel
Suitable for coastal areas	Yes
Weight	GLTM_11: 0.99kg, GLTM_14: 1.56kg, GLTM_16: 2.03kg, GLTM_19: 3.26kg, GLTM_22: 3.98kg
Maximum ambient temperature	-25°C - 40°C
SELV	Yes
Electric class (1, 2, 3)	1
Earth leakage	0.1mA

Photometrics @ 25°C

Product code	Type	Finish	W	CCT	∠°	lm	lm/W	Energy
GLTMS119T30	Ø119mm cut-out	Stainless steel 316	6W	3000K	34°	450	75	
GLTMS147T30	Ø147mm cut-out	Stainless steel 316	12W	3000K	34°	1200	100	
GLTMS165T30	Ø165mm cut-out	Stainless steel 316	18W	3000K	34°	1600	89	
GLTMS193T30	Ø193mm cut-out	Stainless steel 316	23W	3000K	34°	2300	100	
GLTMS223T30	Ø223mm cut-out	Stainless steel 316	30W	3000K	34°	3300	100	
GLTMF147T30	Ø147mm cut-out	Stainless steel 316	12W	3000K	60°	1200	100	
GLTMF165T30	Ø165mm cut-out	Stainless steel 316	18W	3000K	60°	1600	89	

Energy rating is a reflection of the LED light source.

Wiring information

Cable / flying lead	Pre-wired 1.0M H05RN-F, 3x1.0mm ²
Type of wiring required	Parallel

Accessories

DM298FP	Faceplate rotary mains dimmer	Sold Separately
DM298GRID	Grid rotary mains dimmer	Sold Separately
JB5	Gel filled waterproof connector	Sold Separately

212

Ground Lights

IP67

IP67 for complete protection against ingress of dust & water

IK08

IK08 (GLTM_11/14) IK10 (GLTM_16/19/22)



Suitable for coastal applications

Guarantee

5 years

Features & benefits

Tilt angle of luminaire is adjustable, just turn knob to tilt the light distribution up to 25 degrees

Static loading capacity is 2000kg

Pre-wired with 1 meter of cable to aid the installer

DALI-2 dimmable and RGBW options also available

Supplied with installation tube

Beam angle: 34° 60°

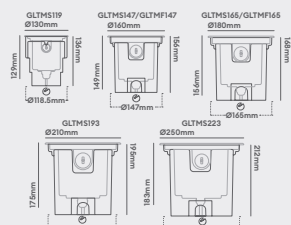
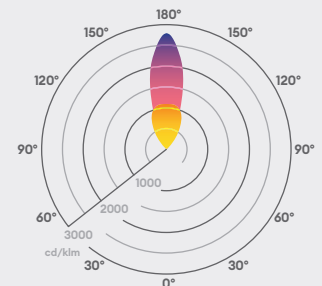

Step Lights



Step lighting

Functional and decorative

Step lights are the perfect solution for highlighting stairs and pathways. They are both functional and decorative whilst highlighting a potentially hazardous area in the dark.

Functional step lighting

Using lighting to highlight steps improves visual aesthetics and enhances safety, whilst adding an inviting glow to your space. Considerations should be made for maintenance and glare when positioning lighting, ensuring ultimate visual appeal and added security knowing the walkway is correctly lit.



Low glare step lighting

The purpose of step lighting is to mark or highlight a particular area. As this type of lighting serves a functional purpose, it is important that the fittings do not cause any visual discomfort from glare.

Hooded

Using a hood over the light will restrict upwards light spill. This results in low visibility of the light source from above and will prevent glare to passers-by.



Asymmetric

An asymmetric light source will direct the light downwards, ensuring the stairway is illuminated without upwards glare, without the need of a hood. Eliminating the need for a hood allows these lights to also be used as ground lights.





Decorative step lighting

Step lights can be used to enhance your landscape, to amplify your overall lighting when entertaining and for commercial exterior lighting. Linking people and spaces together, highlighting steps can make a real difference. Choose Collingwood's range of decorative step lighting which emit light from a decorative face-plate to transform your overall lighting design.



Round and square fittings

Choose between round and square fittings to achieve the ideal style for your installation.



Highlight features as ground lights

The asymmetric beam of step lights makes them great for using as a ground light that directs its light onto a feature.



Step Lights



1W at 350mA or 2W at 700mA



Coastal protected



Low voltage step light

Guarantee

7 years

Features & benefits

- Asymmetric beam angle
- 0% upward light spill
- Recess into a wall, floor or ceiling
- Suitable for indoor and outdoor use
- 33mm cut-out size

Beam angle: 50°

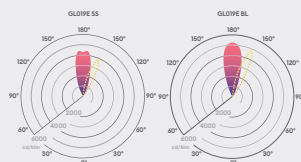

Ø40mm

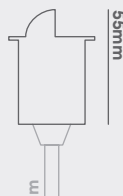

GL019 Eyelid

Asymmetric beam angle with zero upward light spill

Features

IK rating	N/A
IP rating	IP68
CSP switchable	Single CCT
Walk over / Drive over	No
Input	350mA / 700mA
LED lifetime	L70 70,000h
Colour rendering Index	CRI>80
Colour consistency	SDCM3

Installation information

Cut out size (mm)	33
Bathroom zone	0
Inrush current	N/A
Construction material	Anodised aluminium
Suitable for coastal areas	Yes
Weight	120g
Maximum ambient temperature	50°C
SELV	N/A
Electric class (1, 2, 3)	3
Earth leakage	N/A

Photometrics @ 25°C

Product code	Finish	CCT	Beam angle	350mA			700mA			Energy
				W	lm	lm/W	W	lm	lm/W	
GL019E27BL	Black	2700K	50°	1W	31	31	2W	3.3	28	A
GL019E30BL	Black	3000K	50°	1W	36	36	2W	3.8	32	A
GL019E27SS	Stainless steel	2700K	50°	1W	36	36	2W	5	31	A
GL019E30SS	Stainless steel	3000K	50°	1W	41	41	2W	6	36	A

Energy rating is a reflection of the LED light source.

Wiring information

Cable / flying lead	1m (H05RN-F) rubberised cable (outside diameter: 6mm)
Type of wiring required	Series

Recommended LED drivers

See pages 200 - 203 for complete LED driver offer

Product code	Input	SELV	Dimming	Bathroom zone	Products per driver
DRV150700 (all settings)	220-240V	Yes	No	N/A	1-14
DRV350700TD (700mA)	220-240V	Yes	Yes	N/A	4-9
PSIP70018W	220-240V	Yes	No	0	1-8

Accessories

JB2 / JB4 / JB6	IP68 waterproof connectors	Sold Separately	212
TUBE332	Installation tube	Sold Separately	60



GL034 Low Voltage

Hooded Low Voltage Ground Light

Features

IK rating	IK08
IP rating	IP65
CSP switchable	Single CCT
Walk over / Drive over	Walk over (Stainless Steel & Antique Brass Only)
Input	150mA / 250mA / 350mA / 500mA / 700mA
LED lifetime	L70 70,000h
Colour rendering Index	CRI>80
Colour consistency	SDCM3

Installation information

Cut out size (mm)	80-85mm
Bathroom zone	2
Inrush current	N/A
Construction material	Stainless steel 316
Suitable for coastal areas	Yes
Weight	Stainless Steel: 724g
Maximum ambient temperature	35°C
SELV	Yes
Electric class (1, 2, 3)	1
Earth leakage	N/A

Photometrics @ 25°C

Product code	Finish	CCT	∠°	150mA			700mA			Energy
				W	lm	lm/W	W	lm	lm/W	
GL034SS22XF	Stainless steel 316	2200K	40°	0.8W	108	135	4.6W	431	94	
GL034SS27XF	Stainless steel 316	2700K	40°	0.8W	129	161	4.6W	515	112	
GL034SS30XF	Stainless steel 316	3000K	40°	0.8W	130	163	4.6W	520	113	
GL034SS40XF	Stainless steel 316	4000K	40°	0.8W	134	168	4.6W	538	117	

In the part code to replace your colour, change SS to AB (Antique Brass), BK (Black) or BZ (Bronze). **Important:** BK, AB & BZ finish are made to order. Energy rating is a reflection of the LED light source.

Wiring information

Cable / flying lead	1m H05RN-F rubberised cable (outside diameter: 7mm)
Type of wiring required	Parallel

Recommended LED drivers

See pages 200 - 203 for complete LED driver offer

Product code	Input	SELV	Dimming	Bathroom zone	Products per driver
DRV150700 (all settings)	220-240V	Yes	No	N/A	1-6
DRV350700TD (350 & 500mA)	220-240V	Yes	Yes	N/A	3-12
DRV350700TD (700mA)	220-240V	Yes	Yes	N/A	2-4

Accessories

JB5	Gel filled waterproof connector	Sold Separately	212
WC 5-9	Quick release waterproof joint	Sold Separately	212

Step Lights

IP65 IP65 perfect for internal or external applications

Coastal protected

IK08 IK08 impact protection - walk over (Stainless Steel only)

Guarantee

7 years

Features & benefits

Supplied complete with installation tube

SDCM3 ensuring uniform light appearance and consistency

Single LED and lens combination for maximum efficiency and optimal light distribution

CRI 80 providing true colour appearance

Available in a new 2200K setting to create a warm and cosy environment with minimal disruption to natural habitat

Long lifetime of 70,000hrs

Available in an array of colours

Beam angle: 40°

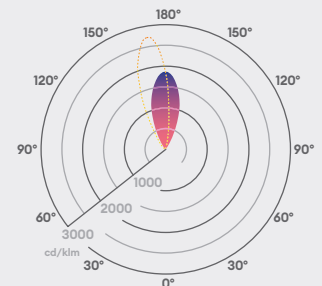

Ø98mm

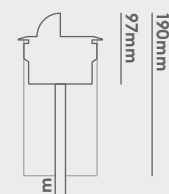





GL034 Mains

Hooded Mains Ground Light

Features

IK rating	IK08
IP rating	IP65
CSP switchable	Single CCT
Walk over / Drive over	Walk over (Stainless Steel & Antique Brass Only)
Input	220-240V AC
LED lifetime	L70 70,000h
Colour rendering index	CRI>80
Colour consistency	SDCM3

Installation information

Cut out size (mm)	80-85mm
Bathroom zone	2
Inrush current	GL034SS: 60A 0.037ms, Other Variant: TBC
Construction material	Stainless steel 316
Suitable for coastal areas	Yes
Weight	Stainless Steel: 724g
Maximum ambient temperature	35°C
SELV	Yes
Electric class (1, 2, 3)	1
Earth leakage	0.1mA

Photometrics @ 25°C

Product code	Finish	W	CCT	∠	lm	lm/W	Energy
GL034SS22MF	Stainless steel 316	2.8W	2200K	40°	154	55	
GL034SS27MF	Stainless steel 316	2.8W	2700K	40°	184	66	
GL034SS30MF	Stainless steel 316	2.8W	3000K	40°	186	66	
GL034SS40MF	Stainless steel 316	2.8W	4000K	40°	192	69	

In the part code to replace your colour, change SS to AB (Antique Brass), BK (Black) or BZ (Bronze). **Important:** BK, AB & BZ finish are made to order. Energy rating is a reflection of the LED light source.

Wiring information

Cable / flying lead	1m H05RN-F rubberised cable (outside diameter: 7mm)
Type of wiring required	Parallel

Accessories

JB5	Gel filled waterproof connector	Sold Separately	212
WC 5-9	Quick release waterproof joint	Sold Separately	212

Step Lights

IP65 IP65 perfect for internal or external applications

Coastal protected

IK08 IK08 impact protection - walk over (Stainless Steel only)

Guarantee

7 years

Features & benefits

Supplied complete with installation tube

SDCM3 ensuring uniform light appearance and consistency

Single LED and lens combination for maximum efficiency and optimal light distribution

CRI 80 providing true colour appearance

Available in a new 2200K setting to create a warm and cosy environment with minimal disruption to natural habitat

Long lifetime of 70,000hrs

Available in an array of colours

Beam angle: 40°

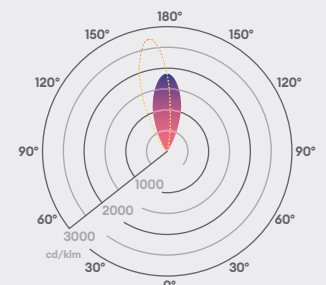

Ø98mm

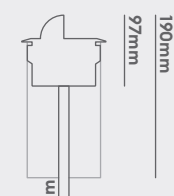

Step Lights

1W 1W at 350mA

 Coastal protected

 Low voltage groundlight

Guarantee

7 years

Features & benefits

Angled light, ideal for use as a step light

Robust cable for outdoor use

Brushed stainless steel for sleek effect



GL021

30° slotted LED ground / step light

Features

IK rating	IK07
IP rating	IP68
CSP switchable	Single CCT
Walk over / Drive over	Walk over (Stainless Steel Only)
Input	350mA
LED lifetime	L70 70,000h
Colour rendering index	CRI>80
Colour consistency	SDCM3

Installation information

Cut out size (mm)	50
Bathroom zone	0
Inrush current	N/A
Construction material	Stainless steel (316)
Suitable for coastal areas	Yes
Weight	400g
Maximum ambient temperature	35°C
SELV	N/A
Electric class (1, 2, 3)	3
Earth leakage	N/A

Photometrics @ 25°C

Product code	Finish	W	CCT	∠	lm	lm/W	Energy
GL021 27	Stainless steel	1W	2700K	30°	8	8	
GL021 NW	Stainless steel	1W	4000K	30°	10	10	

Energy rating is a reflection of the LED light source.

Wiring information

Cable / flying lead	1m (H05RN-F) rubberised cable (outside diameter: 6mm)
Type of wiring required	Series

Recommended LED drivers

See pages 200 - 203 for complete LED driver offer

Product code	Input	SELV	Dimming	Bathroom zone	Products per driver
DRV350700TD (350 & 500mA)	220-240V	Yes	Yes	N/A	4-14
PSIP3509W	220-240V	Yes	No	0	1-8
PSIP35018W	220-240V	Yes	No	1	9-17

Accessories

JB2 / JB4 / JB6	IP68 waterproof connectors	Sold Separately	212
TUBE/50	Installation tube	Sold Separately	60
WCR 275 BLACK	2-core rubber cable	Sold Separately	213

Beam angle: C0/C180

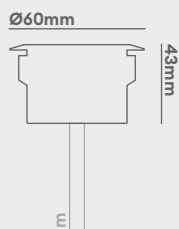
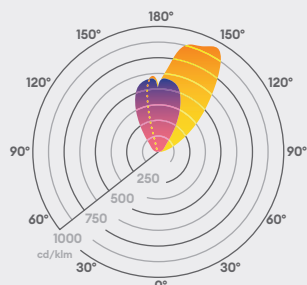



GL022

Square 30° slotted LED ground / step light

Features

IK rating	IK07
IP rating	IP68
CSP switchable	Single CCT
Walk over / Drive over	Walk over (Stainless Steel Only)
Input	350mA
LED lifetime	L70 70,000h
Colour rendering index	CRI>80
Colour consistency	SDCM3

Installation information

Cut out size (mm)	50
Bathroom zone	0
Inrush current	N/A
Construction material	Stainless steel (316)
Suitable for coastal areas	Yes
Weight	400g
Maximum ambient temperature	35°C
SELV	N/A
Electric class (1, 2, 3)	3
Earth leakage	N/A

Photometrics @ 25°C

Product code	Finish	W	CCT	∠°	lm	lm/W	Energy
GL022 27	Stainless steel	1W	2700K	30°	8	8	
GL022 WW	Stainless steel	1W	3000K	30°	8	8	
GL022 NW	Stainless steel	1W	4000K	30°	10	10	

Energy rating is a reflection of the LED light source.

Wiring information

Cable / flying lead	1m (H05RN-F) rubberised cable (outside diameter: 6mm)
Type of wiring required	Series

Recommended LED drivers

See pages 200 - 203 for complete LED driver offer

Product code	Input	SELV	Dimming	Bathroom zone	Products per driver
DRV350700TD (350 & 500mA)	220-240V	Yes	Yes	N/A	4-14
PSIP3509W	220-240V	Yes	No	0	1-8
PSIP35018W	220-240V	Yes	No	1	9-17

Accessories

JB2 / JB4 / JB6	IP68 waterproof connectors	Sold Separately	212
TUBE/50	Installation tube	Sold Separately	60
WCR 275 BLACK	2-core rubber cable	Sold Separately	213

Step Lights

1W 1W at 350mA

Coastal protected

Low voltage groundlight

Guarantee

7 years

Features & benefits

Angled light, ideal for use as a step light

Robust cable for outdoor use

Brushed stainless steel for sleek effect

Beam angle: C0/C180 C90/C270

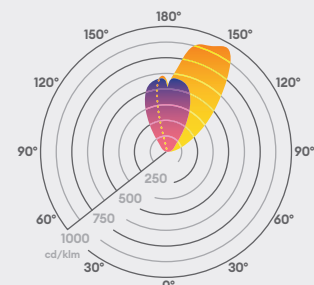

60x60mm

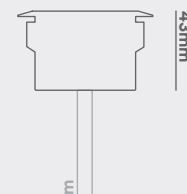

Step Lights

2.6W 2.6W



Coastal protected



Main voltage step light

Guarantee

7 years

Features & benefits

Recessed, asymmetric wall or ground light perfect for illuminating walls, steps and pathways

Available in rustic cast stainless steel and sleek brushed stainless steel finishes

Installation tube included



WL339

Asymmetric, straight to mains, cast finish step light

Features

IK rating	N/A
IP rating	IP65
CSP switchable	Single CCT
Walk over / Drive over	Walk over (Stainless Steel Only)
Input	220-240V AC
LED lifetime	L70 70,000h
Colour rendering index	CRI>80
Colour consistency	SDCM3

Installation information

Cut out size (mm)	80
Bathroom zone	2
Inrush current	9A 0.8ms
Construction material	Stainless steel (316)
Suitable for coastal areas	Yes
Weight	1000g
Maximum ambient temperature	35°C
SELV	Yes
Electric class (1, 2, 3)	1
Earth leakage	0.1mA

Photometrics @ 25°C

Product code	Finish	W	CCT	⤴	lm	lm/W	Energy
WL339WW	Stainless steel	2.6W	3000K	50°	50	19	

Energy rating is a reflection of the LED light source.

Wiring information

Cable / flying lead	1m (H05RN-F) rubberised cable (outside diameter: 7mm)
Type of wiring required	Parallel

Accessories

Installation Tube	For easy ground installation	Included	60
JB5	Gel filled waterproof connector	Sold Separately	212
WC 5-9	Quick release waterproof joint	Sold Separately	212

Plane: 50° C0/C180 50° C90/C270

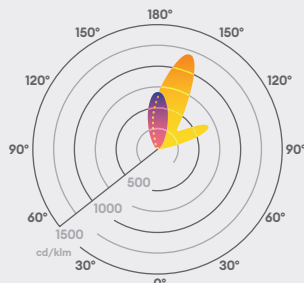

Ø98mm

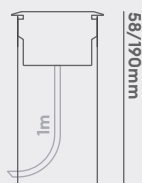



WL340

Asymmetric, straight to mains, step light

Features

IK rating	N/A
IP rating	IP65
CSP switchable	Single CCT
Walk over / Drive over	Walk over (Stainless Steel & Antique Brass Only)
Input	220-240V AC
LED lifetime	L70 70,000h
Colour rendering index	CRI>80
Colour consistency	SDCM3

Installation information

Cut out size (mm)	80
Bathroom zone	2
Inrush current	9A 0.8ms
Construction material	Antique Brass
Suitable for coastal areas	Yes
Weight	1100g
Maximum ambient temperature	35°C
SELV	Yes
Electric class (1, 2, 3)	1
Earth leakage	0.1mA

Photometrics @ 25°C

Product code	Finish	W	CCT	∠°	lm	lm/W	Energy
WL340AB27	Antique brass	2.6W	2700K	50°	49	19	
WL340ABWW	Antique brass	2.6W	3000K	50°	50	19	
WL340WW	Stainless steel	2.6W	3000K	50°	50	19	

Energy rating is a reflection of the LED light source.

Wiring information

Cable / flying lead	1m (H05RN-F) rubberised cable (outside diameter: 7mm)
Type of wiring required	Parallel

Accessories

Installation Tube	For easy ground installation	Included	60
JB5	Gel filled waterproof connector	Sold Separately	212
WC 5-9	Quick waterproof connector	Sold Separately	212

Step Lights

2.6W 2.6W

Coastal protected

Main voltage step light

Guarantee

7 years

Features & benefits

Installation tube included

Ideal for illuminating walls, steps and pathways

Plane: 50° C0/C180 50° C90/C270

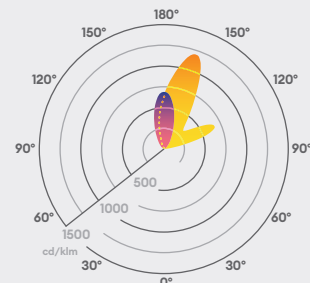

Ø98mm

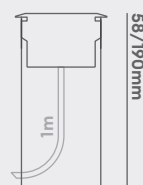

Step Lights

2.6W 2.6W



Coastal protected



Main voltage step light

Guarantee

7 years

Features & benefits

Can be used as a wall light or ground light

Installation tube included

1m H05RN-F rubber cable attached for permanent use outdoors



WL341

Asymmetric, straight to mains, cast finish step light

Features

IK rating	N/A
IP rating	IP65
CSP switchable	Single CCT
Walk over / Drive over	Walk over (Stainless Steel Only)
Input	220-240V AC
LED lifetime	L70 70,000h
Colour rendering index	CRI>80
Colour consistency	SDCM3

Installation information

Cut out size (mm)	80
Bathroom zone	2
Inrush current	9A 0.8ms
Construction material	Stainless steel (316)
Suitable for coastal areas	Yes
Weight	1000g
Maximum ambient temperature	35°C
SELV	Yes
Electric class (1, 2, 3)	1
Earth leakage	0.1mA

Photometrics @ 25°C

Product code	Finish	W	CCT	∠	lm	lm/W	Energy
WL341WW	Stainless steel	2.6W	3000K	50°	50	19	

Energy rating is a reflection of the LED light source.

Wiring information

Cable / flying lead	1m (H05RN-F) rubberised cable (outside diameter: 7mm)
Type of wiring required	Parallel

Accessories

Installation Tube	For easy ground installation	Included	60
JB5	Gel filled waterproof connector	Sold Separately	212
WC 5-9	Quick release waterproof joint	Sold Separately	212

Plane: 50° C0/C180 50° C90/C270

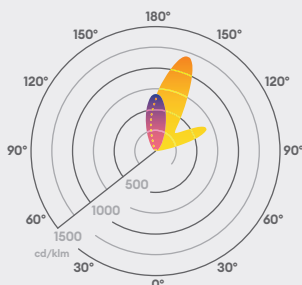

98x98mm

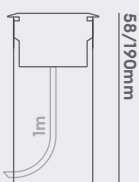



WL342

Asymmetric, straight to mains, brush finish step light

Features

IK rating	N/A
IP rating	IP65
CSP switchable	Single CCT
Walk over / Drive over	Walk over (Stainless Steel & Antique Brass Only)
Input	220-240V AC
LED lifetime	L70 70,000h
Colour rendering index	CRI>80
Colour consistency	SDCM3

Installation information

Cut out size (mm)	80
Bathroom zone	2
Inrush current	9A 0.8ms
Construction material	Stainless steel (316) antique brass
Suitable for coastal areas	Yes
Weight	1.2Kg
Maximum ambient temperature	35°C
SELV	Yes
Electric class (1, 2, 3)	1
Earth leakage	0.1mA

Photometrics @ 25°C

Product code	Finish	W	CCT	∠	lm	lm/W	Energy
WL342AB27	Antique brass	2.6W	2700K	50°	49	19	A B
WL342AB30	Antique brass	2.6W	3000K	50°	50	19	A B
WL342WW	Stainless steel	2.6W	3000K	50°	50	19	A B

Energy rating is a reflection of the LED light source.

Wiring information

Cable / flying lead	1m (H05RN-F) rubberised cable (outside diameter: 7mm)
Type of wiring required	Parallel

Accessories

Installation Tube	For easy ground installation	Included	60
JB5	Gel filled waterproof connector	Sold Separately	212
WC 5-9	Quick release waterproof joint	Sold Separately	212

Step Lights

2.6W 2.6W

Coastal protected

Main voltage step light

Guarantee

7 years

Features & benefits

Can be used as a wall light or ground light

Installation tube included

1m H05RN-F rubber cable attached for permanent use outdoors

Plane: 50° C0/C180 50° C90/C270

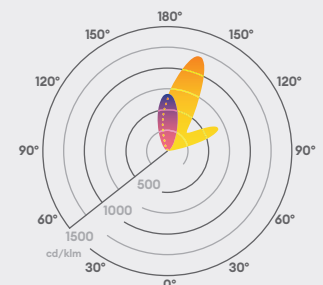

98x98mm

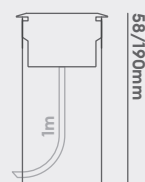

Spike Lights



Spike lights

To create engaging outdoor spaces

Whether lighting a pathway, planting or to really embellish an outdoor feature, spike lights are a great addition to any environment.

Choose your effect

Spike lights can be used in a variety of ways, for example, illuminating pathways, highlighting mid-level planting or to pick out certain features within a garden. The great thing about these products is that they can move as your landscape changes season to season, year to year.



Pathways



Mid-level planting



Features

Layering light

Spike lights can effectively work as the main focus of an outdoor lighting scheme; however, they also work well in spreading the focus throughout an installation. Combine various effects using these versatile fittings to light features at different levels and to create a scene with depth and interest. Pathway lighting can be combined with uplighting to create a multi-layered effect.



Light confined to one area



Light spread across installation

Product comparison

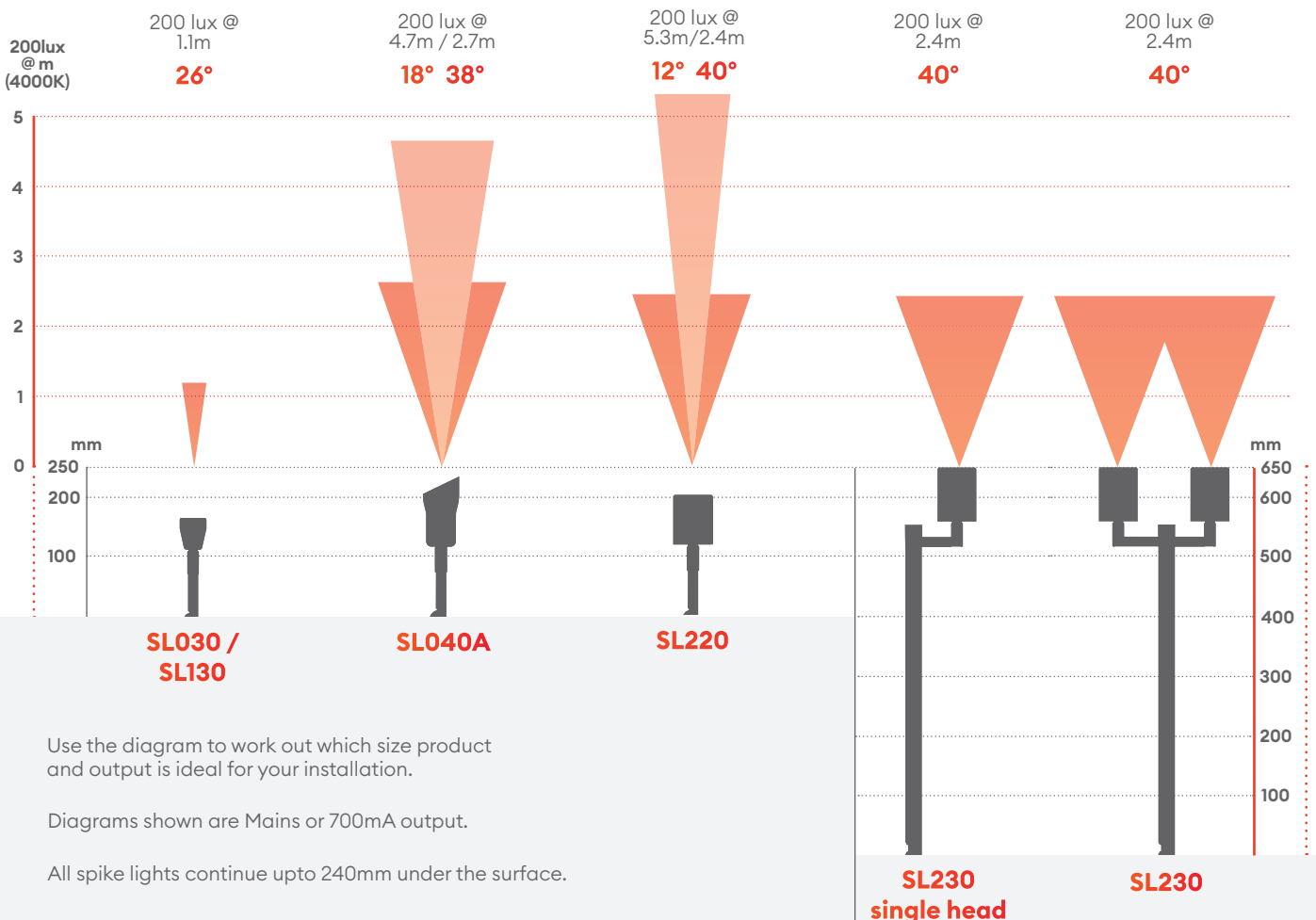

Low voltage Vs mains

Choose the right connection for any install with both mains and low voltage options available. These are ideal for both retro-fit and new installations.

All of our spike lights come with 3m integrated cable as standard for ease of installation.

Waterproof

Our spike lights are waterproof to IP65 and have been designed for permanent use outdoors. Spike lights must be installed using waterproof connections to avoid moisture ingress through non-waterproof joints. To choose from our range waterproof connectors, please see [page 212](#).



Low glare hoods and snoots

Upgrade the look and feel of your spike light installation with a simple low glare hood or snoot accessory. The accessories minimise any 'spill light' from the product to create a crisp beam of light which is low glare.

Standard spike light

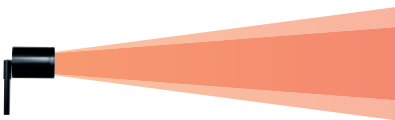

Flexible spike lighting with a high-quality fixture. Without using an accessory the beam of light has a soft halo around the measured beam angle.

Low glare hood

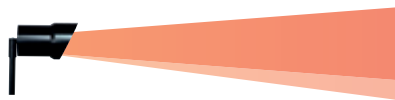

A simple solution to create discreet lighting whilst optimising the light distribution. The widest part of the hood reduces the spill light from one side of the light.

Low glare snoot



This cylindrical snoot accentuates the style factor. Perfect for creating a moonlight effect the snoot reduces the spill light in all directions.

Discreet lighting

Conceal your spike lights to allow attention to focus on the illumination, not the light source.

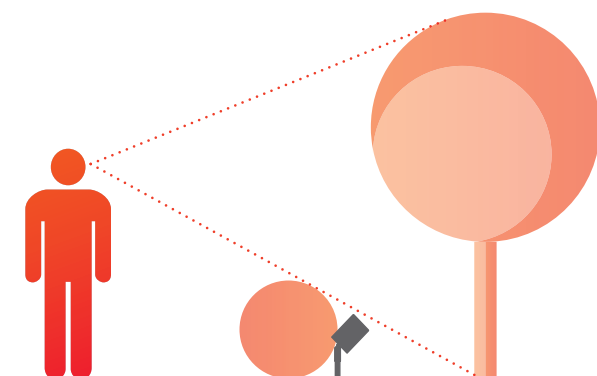

Flexibility

Spike lights are the most flexible lighting choice for a garden as they can be used in a variety of environments and are easy to manoeuvre, which gives the option to change the lighting scheme to reflect the season.

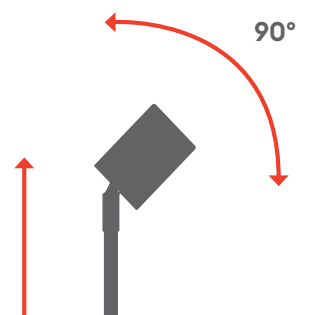

Tilt

Select the best angle to illuminate features.

Move

Simply pick up and move a spike light to illuminate a different feature.

Spike Lights



1W at 350mA or 2W at 700mA



Coastal protected



IP65 ideal for outdoor areas

Guarantee

7 years

Features & benefits

Long spike included for extra stability

Robust cable for outdoor use

Small & discreet

Single Point Source LED



SLO30 | SL130

1W LED spike light

Features

IP rating	IP65
CSP switchable	Single CCT
Tilttable	90°
Input	350mA / 700mA
LED lifetime	L70 70,000h
Colour rendering Index	CRI>80
Colour consistency	SDCM3

Installation information

Inrush current	N/A
Construction material	Stainless steel (316)
Suitable for coastal areas	Yes
Weight	700g
Maximum ambient temperature	35°C
SELV	N/A
Electric class (1, 2, 3)	3
Earth leakage	N/A

Photometrics @ 25°C

Product code	Finish	CCT	Beam angle	350mA			700mA			Energy
				W	lm	lm/W	W	lm	lm/W	
SL030 F27	Stainless steel 316	2700K	26°	1W	70	70	2W	337	60	
SL030 FWW	Stainless steel 316	3000K	26°	1W	75	75	2W	379	68	
SL13027	Black anodised aluminium	2700K	26°	1W	70	70	2W	337	60	
SL13030	Black anodised aluminium	3000K	26°	1W	75	75	2W	379	68	
SL130ZMBX27	Bronze anodised aluminium	2700K	26°	1W	70	70	2W	337	60	
SL130ZMBX30	Bronze anodised aluminium	3000K	26°	1W	75	75	2W	379	68	

Energy rating is a reflection of the LED light source.

Beam angle: 26°

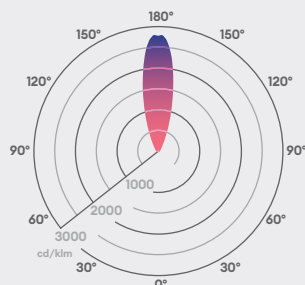

Wiring information

Cable / flying lead	3m H05RN-F rubberised cable (outside diameter: 6mm)
Type of wiring required	Series

Recommended LED drivers

See pages 200 - 203 for complete LED driver offer

Product code	Input	SELV	Dimming	Bathroom zone	Products per driver
DRV150700 (all settings)	220-240V	Yes	No	N/A	1-14
DRV350700TD (700mA)	220-240V	Yes	Yes	N/A	4-9
PSIP70018W	220-240V	Yes	No	1	1-8

Accessories

JB2 / JB4 / JB6	Waterproof junction box / Gel filled waterproof connectors	212
WCR 275 BLACK	2-core rubber cable	213

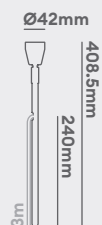



SL040A

High output LED spike light

Features

IP rating	IP65
CSP switchable	Single CCT
Tilttable	90°
Input	700mA
LED lifetime	L70 70,000h
Colour rendering Index	CRI>80
Colour consistency	SDCM3

Installation information

Inrush current	N/A
Construction material	Anodised aluminium
Suitable for coastal areas	Yes
Weight	600g
Maximum ambient temperature	35°C
SELV	N/A
Electric class (1, 2, 3)	3
Earth leakage	N/A

Photometrics @ 25°C

Product code	Finish	W	CCT	∠°	lm	lm/W	Energy
SL040A F 27	Black anodised aluminium	7W	2700K	18°	377	54	
SL040A F WW	Black anodised aluminium	7W	3000K	18°	413	59	
SL040A S 27	Black anodised aluminium	7W	2700K	38°	377	54	
SL040A S WW	Black anodised aluminium	7W	3000K	38°	413	59	

Energy rating is a reflection of the LED light source.

Wiring information

Cable / flying lead	3m H05RN-F rubberised cable (outside diameter: 6mm)
Type of wiring required	Series

Recommended LED drivers

See pages 200 - 203 for complete LED driver offer

Product code	Input	SELV	Dimming	Bathroom zone	Products per driver
DRV150700 (all settings)	220-240V	Yes	No	N/A	1-4
DRV350700TD (700mA)	220-240V	Yes	Yes	N/A	2-3
PSDIM700	220-240V	Yes	Yes (1-10V)	1	1-6

Accessories

JB2 / JB4 / JB6	Waterproof junction box / Gel filled waterproof connectors	Sold Separately	212
WCR 275 BLACK	2-core rubber cable	Sold Separately	213

Spike Lights

7W 7W

Coastal protected

IP65 IP65 ideal for outdoor areas

Guarantee

7 years

Features & benefits

Long spike included for extra stability

Robust cable for outdoor use

Hooded for reduced glare

Beam angle: 18°

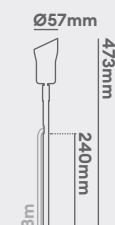
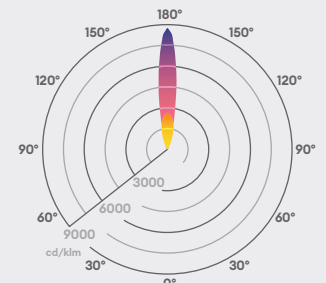

Spike Lights



Switchable driver option for quick and easy installation



Coastal protected



IP65 ideal for outdoor areas

Guarantee

7 years

Features & benefits

Tiltable for flexible lighting direction to help suit any installation

SDCM3 ensuring uniform light appearance and consistency

Single LED and lens combination for maximum efficiency and optimal light distribution

Choice of material finish to suit different styles

Beam angle: 40° 12°

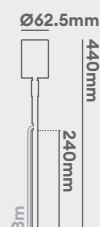
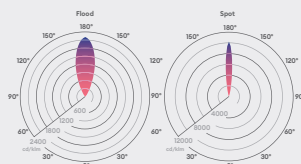

SL220 Low Voltage

Low Voltage LED Spike light

Features

IP rating	IP65
CSP switchable	Single CCT
Input	150mA / 250mA / 350mA / 500mA / 700mA
LED lifetime	L70 70,000h
Colour rendering index	CRI>80
Colour consistency	SDCM3

Installation information

Inrush current	0.07ms 5.2A
Construction material	Stainless Steel 316
Suitable for coastal areas	Yes
Weight	SL220AB: TBC, SL220BK: 580g, SL220SS: 1054g, SL220BZ: 588g
Maximum ambient temperature	55°C
SELV	Yes
Electric class (1, 2, 3)	3
Earth leakage	N/A

Photometrics @ 25°C

Product code	Finish	CCT	Beam angle	150mA			700mA			Energy
				W	lm	lm/W	W	lm	lm/W	
SL220SS22XF	Stainless steel	2200K	40°	0.8W	108	135	4.6W	421	94	Ⓐ E
SL220SS22XS	Stainless steel	2200K	12°	0.8W	108	135	4.6W	421	94	Ⓐ E
SL220SS27XF	Stainless steel	2700K	40°	0.8W	129	161	4.6W	515	112	Ⓐ E
SL220SS27XS	Stainless steel	2700K	12°	0.8W	129	161	4.6W	515	112	Ⓐ E
SL220SS30XF	Stainless steel	3000K	40°	0.8W	130	163	4.6W	520	113	Ⓐ E
SL220SS30XS	Stainless steel	3000K	12°	0.8W	130	163	4.6W	520	113	Ⓐ E
SL220SS40XF	Stainless steel	4000K	40°	0.8W	134	168	4.6W	538	117	Ⓐ E
SL220SS40XS	Stainless steel	4000K	12°	0.8W	134	168	4.6W	538	117	Ⓐ E

In the part code to replace your colour, change SS to AB (Antique Brass), BK (Black) or BZ (Bronze). **Important:** AB finish is made to order. Energy rating is a reflection of the LED light source.

Wiring information

Cable / flying lead	3m H05RN-F rubberised cable (outside diameter: 6mm)
Type of wiring required	Series

Recommended LED drivers

See pages 200 - 203 for complete LED driver offer

Product code	Input	SELV	Dimming	Bathroom zone	Products per driver
DRV150700 (all settings)	220-240V	Yes	No	N/A	1-6
DRV350700TD (350 & 500mA)	220-240V	Yes	Yes	N/A	2-6
DRV350700TD (700mA)	220-240V	Yes	Yes	N/A	2-4

Accessories

JB2 / JB4 / JB6	Waterproof junction box / Gel filled waterproof connectors	Sold Separately	212
GH220	Simple hood to reduce glare whilst maintaining a good light distribution	Sold Separately	89
GS220	Stylish, baffle-style snoot, perfect for creating a moonlighting effect	Sold Separately	89



SL220 Mains Voltage

Mains Voltage LED Spike light

Features

IP rating	IP65
CSP switchable	Single CCT
Tilttable	90°
Input	220-240V AC
LED lifetime	L70 70,000h
Colour rendering Index	CRI>80
Colour consistency	SDCM3

Installation information

Inrush current	0.07ms 5.2A
Construction material	Stainless Steel 316
Suitable for coastal areas	Yes
Weight	SL220AB: TBC, SL220BK: 714g, SL220SS: 1156g, SL220BZ: 694g
Maximum ambient temperature	55°C
SELV	Yes
Electric class (1, 2, 3)	1
Earth leakage	0.1mA

Photometrics @ 25°C

Product code	Finish	W	CCT	∠	lm	lm/W	Energy
SL220SS22MF	Stainless steel	5.7W	2200K	40°	431	76	
SL220SS22MS	Stainless steel	5.7W	2200K	12°	431	76	
SL220SS27MF	Stainless steel	5.7W	2700K	40°	515	90	
SL220SS27MS	Stainless steel	5.7W	2700K	12°	515	90	
SL220SS30MF	Stainless steel	5.7W	3000K	40°	520	91	
SL220SS30MS	Stainless steel	5.7W	3000K	12°	520	91	
SL220SS40MF	Stainless steel	5.7W	4000K	40°	538	94	
SL220SS40MS	Stainless steel	5.7W	4000K	12°	538	94	

In the part code to replace your colour, change SS to AB (Antique Brass), BK (Black) or BZ (Bronze). **Important:** AB finish is made to order. Energy rating is a reflection of the LED light source.

Wiring information

Cable / flying lead	3m H05RN-F rubberised cable (outside diameter: 6mm)
Type of wiring required	Parallel

Accessories

JB5	Gel filled waterproof connector	Sold Separately	212
GH220	Simple hood to reduce glare whilst maintaining a good light distribution	Sold Separately	89
GS220	Stylish, baffle-style snoot, perfect for creating a moonlighting effect	Sold Separately	89

Spike Lights

5.7W 5.7W

Coastal protected

IP65 IP65 ideal for outdoor areas

Guarantee

7 years

Features & benefits

Tilttable for flexible lighting direction to help suit any installation

SDCM3 ensuring uniform light appearance and consistency

Single LED and lens combination for maximum efficiency and optimal light distribution

Choice of material finish to suit different styles

Beam angle: 40° 12°

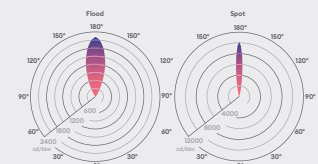

Ø62.5mm

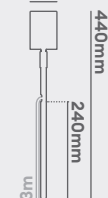

Spike Lights

2.2W
or
4.6W

2.2W at 350mA or
4.6W at 700mA



Coastal protected

IP65

IP65 ideal for
outdoor areas

Guarantee

7 years

Features & benefits

Single LED and lens combination for maximum efficiency and optimal light distribution

Choice of material finish to suit different styles

Choose from a range of hoods for reduced glare.



GH220B



GS220B

SL230 Single Head

Low voltage single head LED spike light

Features

IP rating	IP65
CSP switchable	Single CCT
Tilttable	90°
Input	350mA / 700mA
LED lifetime	L70 70,000h
Colour rendering Index	CRI>80
Colour consistency	SDCM3

Installation information

Inrush current	N/A
Construction material	Anodised aluminium
Suitable for coastal areas	Yes
Weight	1.05
Maximum ambient temperature	50°C
SELV	N/A
Electric class (1, 2, 3)	3
Earth leakage	N/A

Photometrics @ 25°C

Product code	Finish	CCT	Beam angle	350mA			700mA			Energy
				W	lm	lm/W	W	lm	lm/W	
SLX230SHA30	Anthracite	3000K	40°	2.2W	300	136	4.6W	1182	113	
SLX230SHB30	Black	3000K	40°	2.2W	300	136	4.6W	1182	113	

Energy rating is a reflection of the LED light source.

Wiring information

Cable / flying lead	3m H05RN-F rubberised cable (outside diameter: 6mm)
Type of wiring required	Series

Recommended LED drivers

See pages 200 - 203 for complete LED driver offer

Product code	Input	SELV	Dimming	Bathroom zone	Products per driver
DRV150700 (all settings)	220-240V	Yes	No	N/A	1-6
DRV350700TD (700mA)	220-240V	Yes	Yes	N/A	2-4
PSIP70018W	220-240V	Yes	No	1	1-3

Accessories

JB2 / JB4 / JB6	Waterproof junction box / Gel filled waterproof connectors	Sold Separately	212
GH220	Simple hood to reduce glare whilst maintaining a good light distribution	Sold Separately	89
GS220	Simple hood to reduce glare whilst maintaining a good light distribution	Sold Separately	89

Beam angle: 40°

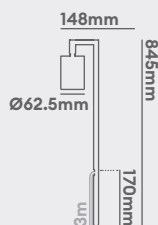
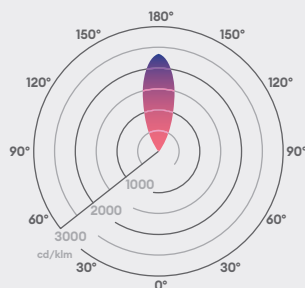



SL230 Single Head Mains

Mains voltage single head LED spike light

Features

IP rating	IP65
CSP switchable	Single CCT
Tilttable	90°
Input	220-240V AC
LED lifetime	L70 70,000h
Colour rendering Index	CRI>80
Colour consistency	SDCM3

Installation information

Inrush current	60A 37µs (SLM230SH_...)
Construction material	Anodised aluminium
Suitable for coastal areas	Yes
Weight	1.18
Maximum ambient temperature	50°C
SELV	Yes
Electric class (1, 2, 3)	1
Earth leakage	0.1mA

Photometrics @ 25°C

Product code	Finish	W	CCT	∠°	lm	lm/W	Energy
SLM230SHA30	Anthracite	5.7W	3000K	40°	520	91	
SLM230SHB30	Black	5.7W	3000K	40°	520	91	

Energy rating is a reflection of the LED light source.

Wiring information

Cable / flying lead	3m H05RN-F rubberised cable (outside diameter: 7mm)
Type of wiring required	Parallel

Accessories

JB5	Gel filled waterproof connector	Sold Separately	212
GH220	Simple hood to reduce glare whilst maintaining a good light distribution	Sold Separately	89
GS220	Simple hood to reduce glare whilst maintaining a good light distribution	Sold Separately	89

Spike Lights

5.7W 5.7W

Coastal protected

IP65 IP65 ideal for outdoor areas

Guarantee

7 years

Features & benefits

High efficacy of 91lm/W

Single LED and lens combination for maximum efficiency and optimal light distribution

Choice of material finish to suit different styles

Choose from a range of hoods for reduced glare.

Beam angle: 40°

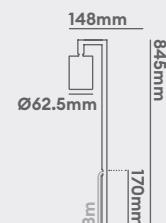
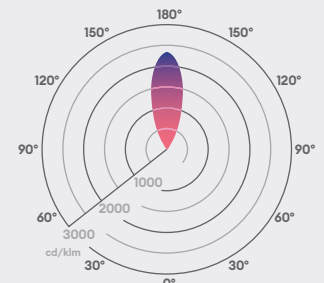

Spike Lights

4.4W or 9.2W 4.4W at 350mA or 9.2W at 700mA

 Coastal protected

IP65 IP65 ideal for outdoor areas

Guarantee

7 years

Features & benefits

Adjustable pole-mounted twin heads are perfect for illuminating paths, steps and trees

Easily ground mounted with spiked pole and single cable for quick installation

Elegant and discreet black and bronze finishes

Highly efficiency of 114lm/W

Discreet cabling

Beam angle: 40°

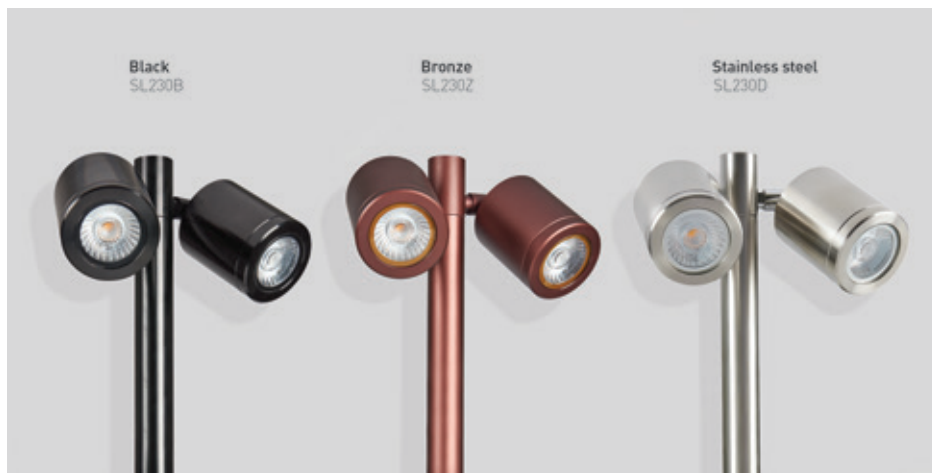
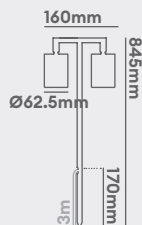
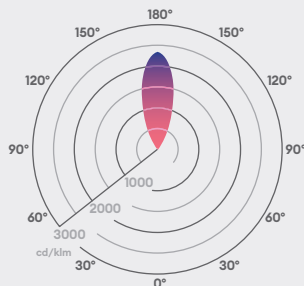

SL230

Low voltage LED twin pole spike light

Features

IP rating	IP65
CSP switchable	Single CCT
Tilttable	90°
Input	350mA / 700mA
LED lifetime	L70 70,000h
Colour rendering Index	CRI>80
Colour consistency	SDCM3

Installation information

Inrush current	N/A
Construction material	Anodised aluminium
Suitable for coastal areas	Yes
Weight	SL230B: 1432g SL230D: 3200g SL230Z: 1401g
Maximum ambient temperature	35°C
SELV	N/A
Electric class (1, 2, 3)	3

Photometrics @ 25°C

Product code	Finish	CCT	Beam angle	350mA			700mA			Energy
				W	lm	lm/W	W	lm	lm/W	
SL230BWBX27	Black anodised aluminium	2700K	40°	4.4W	580	135	9.2W	2 x 1171	111	
SL230BWBX30	Black anodised aluminium	3000K	40°	4.4W	580	140	9.2W	2 x 1182	112	
SL230DWBX30	Stainless steel	3000K	40°	4.4W	580	140	9.2W	2 x 1182	112	
SL230ZWBX27	Bronze anodised aluminium	2700K	40°	4.4W	580	135	9.2W	2 x 1171	111	
SL230ZWBX30	Bronze anodised aluminium	3000K	40°	4.4W	600	140	9.2W	2 x 1182	112	

Energy rating is a reflection of the LED light source.

Wiring information

Cable / flying lead	3m H05RN-F rubberised cable (outside diameter: 6mm)
Type of wiring required	Series

Recommended LED drivers

See pages 200 - 203 for complete LED driver offer

Product code	Input	SELV	Dimming	Bathroom zone	Products per driver
DRV150700 (all settings)	220-240V	Yes	No	N/A	1-3
DRV350700TD (700mA)	220-240V	Yes	Yes	N/A	1-2
PSIP70036W	220-240V	Yes	No	1	2-3

Accessories

JB2 / JB4 / JB6	Waterproof junction box / Gel filled waterproof connectors	Sold Separately	212
GH220	Simple hood to reduce glare whilst maintaining a good light distribution	Sold Separately	89
GS220	Simple hood to reduce glare whilst maintaining a good light distribution	Sold Separately	89

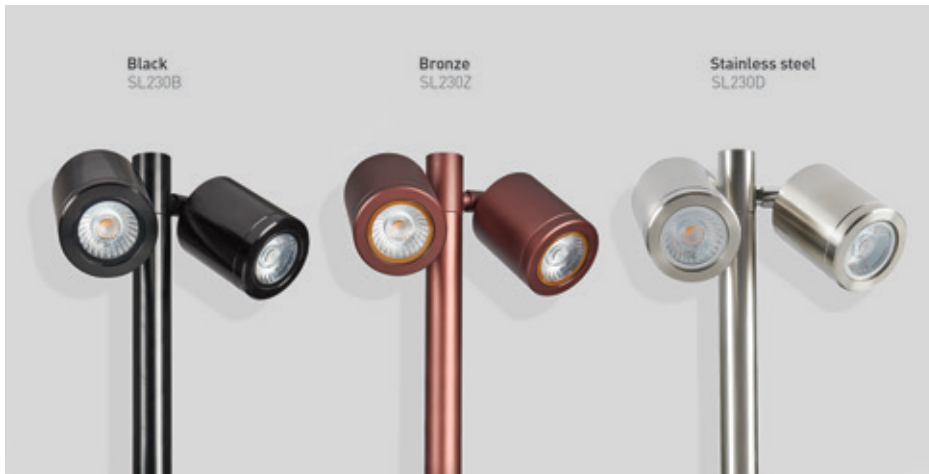

SL230 Mains

Mains voltage LED twin pole spike light

Features

IP rating	IP65
CSP switchable	Single CCT
Tilttable	90°
Input	220-240V AC
LED lifetime	L70 70,000h
Colour rendering Index	CRI>80
Colour consistency	SDCM3

Installation information

Inrush current	120A 37μs
Construction material	Anodised aluminium
Suitable for coastal areas	Yes
Weight	SL230B: 1578g SL230D: 3500g SL230Z: 1577g
Maximum ambient temperature	35°C
SELV	Yes
Electric class (1, 2, 3)	1
Earth leakage	0.1mA

Photometrics @ 25°C

Product code	Finish	W	CCT	∠	lm	lm/W	Energy
SL230BWBM27	Black anodised aluminium	11.4W	2700K	40°	1030	2 x 90	
SL230BWBM30	Black anodised aluminium	11.4W	3000K	40°	1040	2 x 91	
SL230DWBM27	Stainless steel	11.4W	2700K	40°	1030	2 x 90	
SL230DWBM30	Stainless steel	11.4W	3000K	40°	1040	2 x 91	
SL230ZWBM30	Bronze anodised aluminium	11.4W	3000K	40°	1040	2 x 91	

Energy rating is a reflection of the LED light source.

Wiring information

Cable / flying lead	3m H05RN-F rubberised cable (outside diameter: 7mm)
Type of wiring required	Parallel

Accessories

JB5	Gel filled waterproof connector	Sold Separately	212
GH220	Simple hood to reduce glare whilst maintaining a good light distribution	Sold Separately	89
GS220	Simple hood to reduce glare whilst maintaining a good light distribution	Sold Separately	89

Spike Lights

11.4W

11.4W



Coastal protected

IP65

IP65 ideal for outdoor areas

Guarantee

7 years

Features & benefits

Adjustable pole-mounted twin heads are perfect for illuminating paths, steps and trees

Easily ground mounted with spiked pole and single cable for quick installation

Elegant and discreet black and bronze finishes

Mains voltage for easy installation

Highly efficiency of 93lm/W

Beam angle: 40°

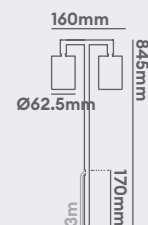
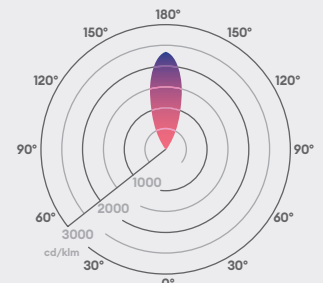



Spike light accessories

Choose the ideal accessory for your spike light

Lower the glare of your spike light for visual comfort and improving it's effect on wildlife.

Choose the ideal accessory

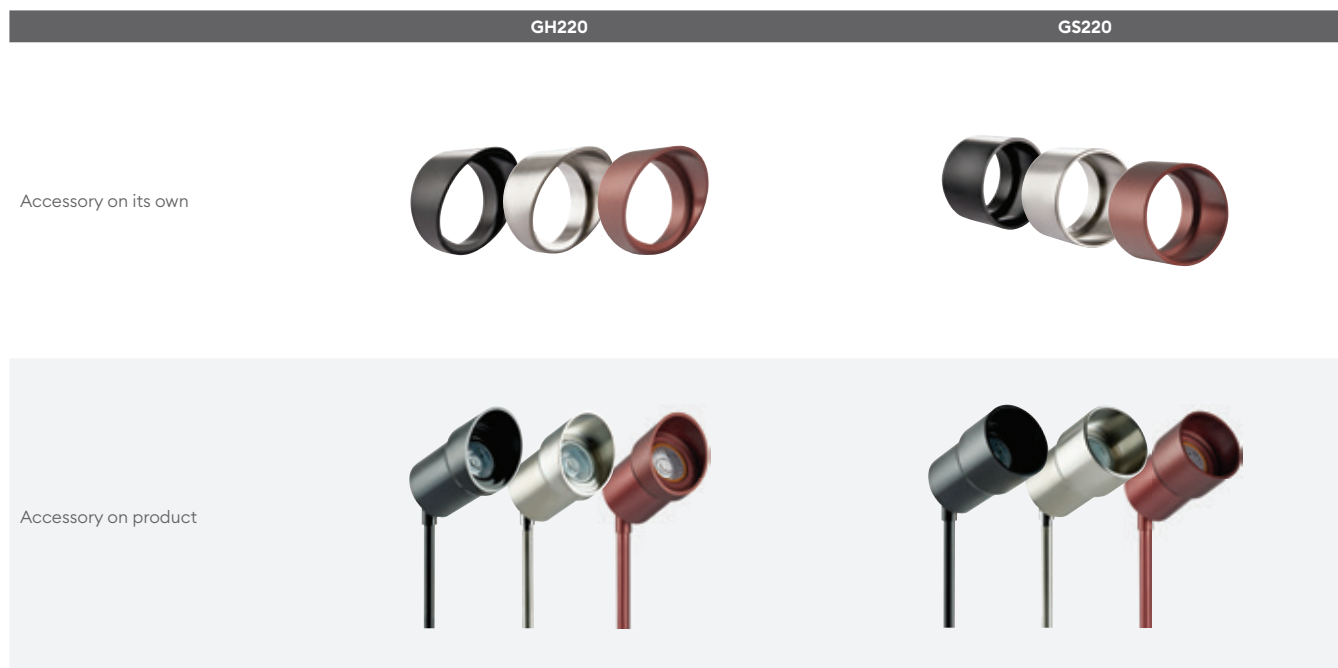

Product codes

Product Code	Finish	Description	Guarantee
GH220B	Black	Low-glare, tapered hood	7 year extended warranty
GH220D	Stainless steel 316	Low-glare, tapered hood	7 year extended warranty
GH220Z	Bronze	Low-glare, tapered hood	7 year extended warranty
GS220B	Black	Low-glare, cylindrical snoot	7 year extended warranty
GS220D	Stainless steel 316	Low-glare, cylindrical snoot	7 year extended warranty
GS220Z	Bronze	Low-glare, cylindrical snoot	7 year extended warranty

For full product specification visit collingwoodlighting.com

Compatible with

	SL220 Page 82	SL220 Mains Page 83	SL230 Single head Page 84	SL230 Single head Mains Page 85	SL230 Page 86	SL230 Mains Page 87
GH220B	●	●	●	●	●	●
GH220D	●	●	●	●	●	●
GH220Z	●	●	●	●	●	●
GS220B	●	●	●	●	●	●
GS220D	●	●	●	●	●	●
GS220Z	●	●	●	●	●	●

Spike Lights



Switchable between 2200K and 3000K



360° even light distribution



IP66 ideal for outdoor areas

Guarantee

5 years

Features & benefits

Installation spike included with product

Water ingress protection device included in cable

Can be dimmable based on driver used

A full range of aesthetical and installation accessories available

DC in Product Code = Domed Cover

FC in Product Code = Flat Cover

Product is delivered with Cover and Installation Spike as standard

Grey RAL 7016, Black RAL 9005

Beam angle: 120°

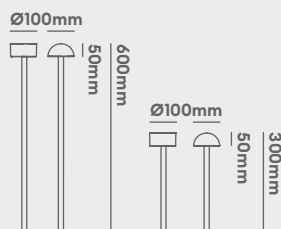
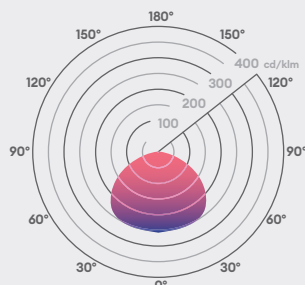

Spydra CSP 300mm Anthracite

CCT colour switchable LED low voltage spike light

Features

IP rating	IP66
CSP switchable	Switchable CCT
Tilttable	No
Input	8-11V DC
LED lifetime	L70 50,000h
Colour rendering Index	CRI>80
Colour consistency	SDCM3

Installation information

Inrush current	N/A
Construction material	Aluminium
Suitable for coastal areas	Yes
Weight	300mm: 430g
Maximum ambient temperature	-20°C - 40°C
SELV	N/A
Electric class (1, 2, 3)	3

Photometrics @ 25°C

Product code	Feature	Finish	W	CCT	∠	lm	lm/W	Energy
SPYA3DCS	Domed Grey	Anthracite	3W	2200K	120°	240	60	
				3000K	120°	310	77	
			6.5W	2200K	120°	450	56	
				3000K	120°	580	73	
SPYA3FCS	Flat Grey	Anthracite	3W	2200K	120°	240	60	
				3000K	120°	310	77	
			6.5W	2200K	120°	450	56	
				3000K	120°	580	73	

Energy rating is a reflection of the LED light source.

Wiring information

Cable / flying lead	3m H05RN-F rubberised cable (outside diameter: 6mm)
Type of wiring required	Series

Recommended LED drivers

See pages 200 - 203 for complete LED driver offer

Product code	Input	SELV	Dimming	Bathroom zone	Products per driver
DRV150700 (all settings)	220-240V	Yes	No	N/A	1-4
DRV350700TD (700mA)	220-240V	Yes	Yes	N/A	1-2
PSIP70018W	220-240V	Yes	No	1	1-2

Accessories

SPYBASEA	Spydra Base Plate for surface mounting, Grey	Sold Separately
SPYBASEB	Spydra Base Plate for surface mounting, Black	Sold Separately
SPYDCOVA	Spydra Domed Cover Round, Grey	Sold Separately
SPYDCOVB	Spydra Domed Cover Round, Black	Sold Separately
SPYFCOVA	Spydra Flat Cover, Grey	Sold Separately
SPYFCOVB	Spydra Flat Cover, Black	Sold Separately



Spydra CSP 600mm Anthracite

CCT colour switchable LED low voltage spike light

Features

IP rating	IP66
CSP switchable	Switchable CCT
Tiltable	No
Input	8-11V DC
LED lifetime	L70 50,000h
Colour rendering Index	CRI>80
Colour consistency	SDCM3

Installation information

Inrush current	N/A
Construction material	Aluminium
Suitable for coastal areas	Yes
Weight	600mm: 510g
Maximum ambient temperature	-20°C - 40°C
SELV	N/A
Electric class (1, 2, 3)	3

Photometrics @ 25°C

Product code	Feature	Finish	W	CCT	∠°	lm	lm/W	Energy
SPYA6DCS	Domed Grey	Anthracite	3W	2200K	120°	240	60	
				3000K	120°	310	77	
				6.5W	2200K	120°	450	
SPYA6FCS	Flat Grey	Anthracite	3W	2200K	120°	240	60	
				3000K	120°	310	77	
				6.5W	2200K	120°	450	
			6.5W	3000K	120°	580	73	

Energy rating is a reflection of the LED light source.

Wiring information

Cable / flying lead	3m H05RN-F rubberised cable (outside diameter: 6mm)
Type of wiring required	Series

Recommended LED drivers

See pages 200 - 203 for complete LED driver offer

Product code	Input	SELV	Dimming	Bathroom zone	Products per driver
DRV150700 (all settings)	220-240V	Yes	No	N/A	1-4
DRV350700TD (700mA)	220-240V	Yes	Yes	N/A	1-2
PSIP70018W	220-240V	Yes	No	1	1-2

Accessories

SPYBASEA	Spydra Base Plate for surface mounting, Grey	Sold Separately
SPYBASEB	Spydra Base Plate for surface mounting, Black	Sold Separately
SPYDCOVA	Spydra Domed Cover Round, Grey	Sold Separately
SPYDCOV B	Spydra Domed Cover Round, Black	Sold Separately
SPYFCOVA	Spydra Flat Cover, Grey	Sold Separately
SPYFCOV B	Spydra Flat Cover, Black	Sold Separately

Spike Lights



Switchable between 2200K and 3000K



360° even light distribution



IP66 ideal for outdoor areas

Guarantee

5 years

Features & benefits

Installation spike included with product

Water ingress protection device included in cable

Can be dimmable based on driver used

A full range of aesthetic and installation accessories available

DC in Product Code = Domed Cover

FC in Product Code = Flat Cover

Product is delivered with Cover and Installation Spike as standard

Grey RAL 7016, Black RAL 9005

Beam angle: 120°

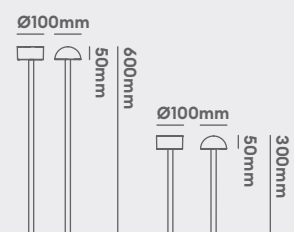
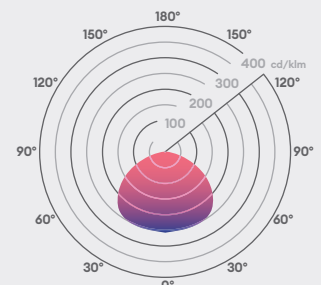

Spike Lights



Switchable between 2200K and 3000K



360° even light distribution



IP66 ideal for outdoor areas

Guarantee

5 years

Features & benefits

Installation spike included with product

Water ingress protection device included in cable

Can be dimmable based on driver used

A full range of aesthetical and installation accessories available

DC in Product Code = Domed Cover

FC in Product Code = Flat Cover

Product is delivered with Cover and Installation Spike as standard

Grey RAL 7016, Black RAL 9005

Beam angle: 120°

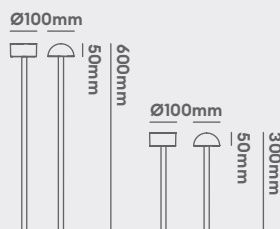
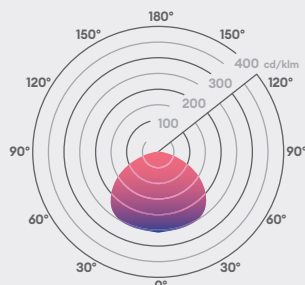

Spydra CSP 300mm Black

CCT colour switchable LED low voltage spike light

Features

IP rating	IP66
CSP switchable	Switchable CCT
Tiltable	No
Input	8-11V DC
LED lifetime	L70 50,000h
Colour rendering Index	CRI>80
Colour consistency	SDCM3

Installation information

Inrush current	N/A
Construction material	Aluminium
Suitable for coastal areas	Yes
Weight	300mm: 430g
Maximum ambient temperature	-20°C - 40°C
SELV	N/A
Electric class (1, 2, 3)	3

Photometrics @ 25°C

Product code	Feature	Finish	W	CCT	∠	lm	lm/W	Energy
SPYB3DCS	Domed Black	Black	3W	2200K	120°	240	60	
				3000K	120°	310	77	
			6.5W	2200K	120°	450	56	
				3000K	120°	580	73	
SPYB3FCS	Flat Black	Black	3W	2200K	120°	240	60	
				3000K	120°	310	77	
			6.5W	2200K	120°	450	56	
				3000K	120°	580	73	

Energy rating is a reflection of the LED light source.

Wiring information

Cable / flying lead	3m H05RN-F rubberised cable (outside diameter: 6mm)
Type of wiring required	Series

Recommended LED drivers

See pages 200 - 203 for complete LED driver offer

Product code	Input	SELV	Dimming	Bathroom zone	Products per driver
DRV150700 (all settings)	220-240V	Yes	No	N/A	1-4
DRV350700TD (700mA)	220-240V	Yes	Yes	N/A	1-2
PSIP70018W	220-240V	Yes	No	1	1-2

Accessories

SPYBASEA	Spydra Base Plate for surface mounting, Grey	Sold Separately
SPYBASEB	Spydra Base Plate for surface mounting, Black	Sold Separately
SPYDCOVA	Spydra Domed Cover Round, Grey	Sold Separately
SPYDCOVB	Spydra Domed Cover Round, Black	Sold Separately
SPYFCOVA	Spydra Flat Cover, Grey	Sold Separately
SPYFCOVB	Spydra Flat Cover, Black	Sold Separately



Spydra CSP 600mm Black

CCT colour switchable LED low voltage spike light

Features

IP rating	IP66
CSP switchable	Switchable CCT
Tiltable	No
Input	8-11V DC
LED lifetime	L70 50,000h
Colour rendering Index	CRI>80
Colour consistency	SDCM3

Installation information

Inrush current	N/A
Construction material	Aluminium
Suitable for coastal areas	Yes
Weight	600mm: 510g
Maximum ambient temperature	-20°C - 40°C
SELV	N/A
Electric class (1, 2, 3)	3

Photometrics @ 25°C

Product code	Feature	Finish	W	CCT	∠°	lm	lm/W	Energy
SPYB6DCS	Domed Black	Black	3W	2200K	120°	240	60	
				3000K	120°	310	77	
				6.5W	2200K	120°	450	
SPYB6FCS	Flat Black	Black	3W	2200K	120°	240	60	
				3000K	120°	310	77	
				6.5W	2200K	120°	450	
			6.5W	3000K	120°	580	73	

Energy rating is a reflection of the LED light source.

Wiring information

Cable / flying lead	3m H05RN-F rubberised cable (outside diameter: 6mm)
Type of wiring required	Series

Recommended LED drivers

See pages 200 - 203 for complete LED driver offer

Product code	Input	SELV	Dimming	Bathroom zone	Products per driver
DRV150700 (all settings)	220-240V	Yes	No	N/A	1-4
DRV350700TD (700mA)	220-240V	Yes	Yes	N/A	1-2
PSIP70018W	220-240V	Yes	No	1	1-2

Accessories

SPYBASEA	Spydra Base Plate for surface mounting, Grey	Sold Separately
SPYBASEB	Spydra Base Plate for surface mounting, Black	Sold Separately
SPYDCOVA	Spydra Domed Cover Round, Grey	Sold Separately
SPYDCOV B	Spydra Domed Cover Round, Black	Sold Separately
SPYFCOVA	Spydra Flat Cover, Grey	Sold Separately
SPYFCOV B	Spydra Flat Cover, Black	Sold Separately

Spike Lights



Switchable between 2200K and 3000K



360° even light distribution



IP66 ideal for outdoor areas

Guarantee

5 years

Features & benefits

Installation spike included with product

Water ingress protection device included in cable

Can be dimmable based on driver used

A full range of aesthetic and installation accessories available

DC in Product Code = Domed Cover

FC in Product Code = Flat Cover

Product is delivered with Cover and Installation Spike as standard

Grey RAL 7016, Black RAL 9005

Beam angle: 120°

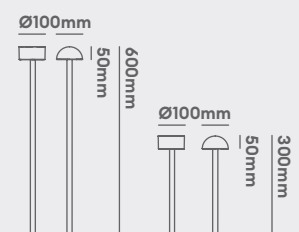
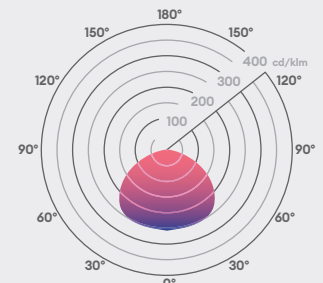

Feature Lights



Feature lights

A flexible solution

Collingwood's outdoor lights have been specifically engineered to cope with challenging environments. Whether illuminating sculptures, plant life or fully immersed in ponds or water features, rest assured that our luminaires are built to last.

Flexibility

With a 360° rotation and 180° tilt, our UL010 and UL030 lights provide ultimate flexibility with the ability to be pointed in any direction, illuminating the areas you want to showcase.

360° rotation

This is achieved with an adjustable bracket at the base of the product.



180° tiltable

Using the bracket directly attached to the product, the light can be tilted upwards and downwards.



Coastal protection

Our UL010 and UL030 products are completely protected from the effects of rust and salt water corrosion. This includes our marine-grade 316 and antique brass finish.

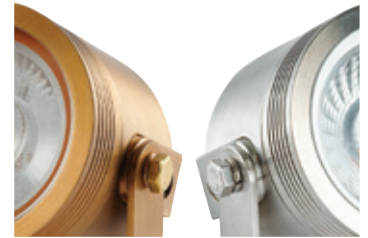

Mount anywhere

Designed with flexibility in mind, our fittings can be mounted on to most surfaces. The screw-in structure allows for attaching to a hard surface securely, where recessing a light is impossible.

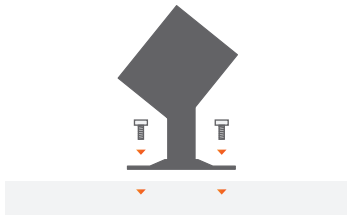

Output options

Both products have a narrow beam which means punchy illumination from a neat and compact fitting. As each installation is unique, it may require a high or low output fitting.

High output

The UL030 is ideal for general illumination.



Low output

The UL010 works well for subtle feature illumination.



Discreet fittings

We understand the focus of lighting should be the illumination, not the fitting, which is why the flexible nature of these products ensures they are easy to conceal in a landscape.



Underwater lighting

Illuminating a pond or water feature will help to transform any landscape design, creating a focal point whilst also adding a layer of protection, and ensuring passers-by are aware of where the later is located.

Lighting effect

A number of effects can be created when strategically lighting water and water features.

Backlighting waterfalls

Adding lighting to the soothing sound of a waterfall can create a calm and peaceful atmosphere.



Reflections

Indirectly illuminate by up lighting surrounding shrubs and trees; unique reflections will be cast into the water.



Highlighting water features

Maintain maximum visual impact after the sun sets by using spot lighting to highlight water features.

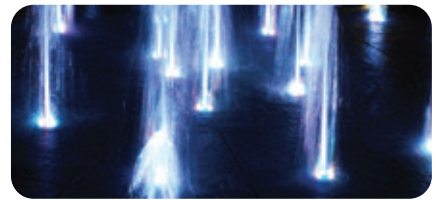

Adding depth to your landscape

Highlighting water features can add significant depth and appeal to the overall landscape design.



Submersible fittings

Our Collingwood patented technology ensures that our UL010 and UL030 IP68 rated feature lights are completely air tight and can be used under water.



The ripple effects

As water moves and ripples, the light moves with it. This adds a sense of motion and fluidity to your scheme and sparks visual interest.







UL030

High output universal LED light

Features

IP rating	IP68
CSP switchable	Single CCT
Tilttable	360°
Rotatable	360°
Dimmable	Driver dependent
Input	150mA / 250mA / 350mA / 500mA / 700mA
LED lifetime	L70 70,000h
Colour rendering index	CRI>80
Colour consistency	SDCM3

Installation information

Inrush current	N/A
Construction material	Stainless Steel 316
Suitable for coastal areas	Yes
Weight	UL030AB: 680g, UL030BK: 680g, UL030SS: 645g, UL030BZ: TBC
Maximum ambient temperature	55°C
SELV	N/A
Electric class (1, 2, 3)	3
Earth leakage	N/A

Photometrics @ 25°C

Product code	Finish	CCT	Beam angle	150mA			700mA			Energy
				W	lm	lm/W	W	lm	lm/W	
UL030SS22XF	Stainless steel	2200K	40°	0.85W	108	135	4.6W	431	94	▶
UL030SS22XS	Stainless steel	2200K	12°	0.85W	108	135	4.6W	431	94	▶
UL030SS27XF	Stainless steel	2700K	40°	0.85W	129	161	4.6W	515	112	▶
UL030SS27XS	Stainless steel	2700K	12°	0.85W	129	161	4.6W	515	112	▶
UL030SS30XF	Stainless steel	3000K	40°	0.85W	130	163	4.6W	520	113	▶
UL030SS30XS	Stainless steel	3000K	12°	0.85W	130	163	4.6W	520	113	▶
UL030SS40XF	Stainless steel	4000K	40°	0.85W	134	168	4.6W	538	117	▶
UL030SS40XS	Stainless steel	4000K	12°	0.85W	134	168	4.6W	538	117	▶

In the part code to replace your colour, change SS to AB (Antique Brass), BK (Black) or BZ (Bronze). **Important:** BZ finish is made to order. Energy rating is a reflection of the LED light source.

Wiring information

Cable / flying lead	1m (H05RN-F) rubberised cable (outside diameter: 6mm)
Type of wiring required	Series

Recommended LED drivers

See pages 200 - 203 for complete LED driver offer

Product code	Input	SELV	Dimming	Bathroom zone	Products per driver
DRV150700 (all settings)	220-240V	Yes	No	N/A	1-6
DRV350700TD (350 & 500mA)	220-240V	Yes	Yes	N/A	2-6
DRV350700TD (700mA)	220-240V	Yes	Yes	N/A	2-4

Accessories

JB2 / JB4	Waterproof junction box / Gel filled waterproof connector	Sold Separately	212
WCR 275 BLACK	2-core rubber cable	Sold Separately	213

Feature Lights



Switchable driver option for quick and easy installation



Coastal Protected



IP68 ideal for outdoor areas and under water lighting

Guarantee

7 years

Features & benefits

Single LED and lens combination for maximum efficiency and optimal light distribution

Complete with wall fixings

Tilt & rotate for adjusting light

Available in an array of colours

Long lifetime of 70,000hrs

Beam angle: 40°

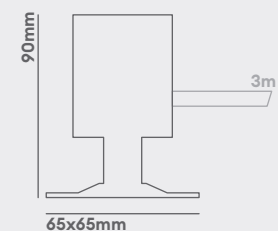
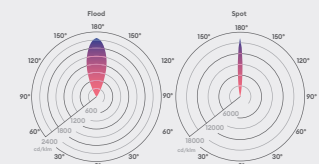

Feature Lights



Switchable driver option for quick and easy installation



Coastal Protected



IP68 ideal for outdoor areas and under water lighting

Guarantee

7 years

Features & benefits

Complete with wall fixings

Robust cable for use outdoors

Tilt & rotate for adjusting light

Available in an array of colours

Long lifetime of 70,000hrs



UL010

Universal LED light

Features

IP rating	IP68
CSP switchable	Single CCT
Tiltable	360°
Rotatable	360°
Dimmable	Driver dependent
Input	150mA / 250mA / 350mA / 500mA / 700mA
LED lifetime	L70 70,000h
Colour rendering index	CRI>80
Colour consistency	SDCM3

Installation information

Inrush current	N/A
Construction material	Stainless Steel 316
Suitable for coastal areas	Yes
Weight	UL010A: 512g, UL010BK: 512g, UL010SS: 500g, UL010BZ: TBC
Maximum ambient temperature	55°C
SELV	N/A
Electric class (1, 2, 3)	3
Earth leakage	N/A

Photometrics @ 25°C

Product code	Finish	CCT	∠°	150mA			700mA			Energy
				W	lm	lm/W	W	lm	lm/W	
UL010SS22XF	Stainless steel	2200K	40°	0.4W	51	120	2.2W	196	89	
UL010SS27XF	Stainless steel	2700K	40°	0.4W	51	120	2.2W	196	89	
UL010SS30XF	Stainless steel	3000K	40°	0.4W	54	129	2.2W	210	95	
UL010SS40XF	Stainless steel	4000K	40°	0.4W	60	143	2.2W	234	106	

In the part code to replace your colour, change SS to AB (Antique Brass), BK (Black) or BZ (Bronze). **Important:** BZ finish is made to order. Energy rating is a reflection of the LED light source.

Wiring information

Cable / flying lead	3m (H05RN-F) rubberised cable (outside diameter: 6mm)
Type of wiring required	Series

Recommended LED drivers

See pages 200 - 203 for complete LED driver offer

Product code	Input	SELV	Dimming	Bathroom zone	Products per driver
DRV150700 (all settings)	220-240V	Yes	No	N/A	1-13
DRV350700TD (350 & 500mA)	220-240V	Yes	Yes	N/A	3-12
DRV350700TD (700mA)	220-240V	Yes	Yes	N/A	3-8

Accessories

JB2 / JB4	Waterproof junction box / Gel filled waterproof connector	Sold Separately	212
WCR 275 BLACK	2-core rubber cable	Sold Separately	213

Beam angle: 40°

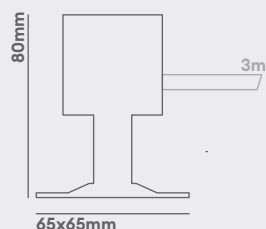
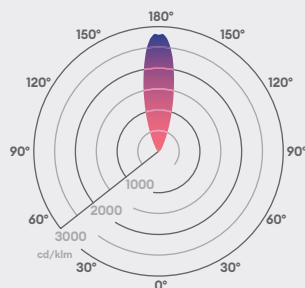



Fountain

Water feature light

Features

IK rating	IK08
IP rating	IP68
CSP switchable	Single CCT
Walk over / Drive over	Walk over (Stainless Steel Only)
Input	24V DC
LED lifetime	L70 50,000h
Colour rendering index	CRI>80
Colour consistency	SDCM3

Installation information

Cut out size (mm)	167
Bathroom zone	0, 1 (with dimming)
Construction material	316 Stainless Steel
Suitable for coastal areas	Yes
Weight	2.58kg
Maximum ambient temperature	-25°C - 40°C
SELV	Yes
Electric class (1, 2, 3)	3
Earth leakage	N/A

Photometrics @ 25°C

Product code	Finish	W	CCT	∠°	lm	lm/W	Energy
FOUX167N30	Stainless steel 316	25W	3000K	35°	1700	68	

Energy rating is a reflection of the LED light source.

Wiring information

Cable / flying lead	Pre-wired 5.0M H05RN-F, 2x1.0mm ²
Type of wiring required	Parallel

Recommended LED drivers

See pages 200 - 203 for complete LED driver offer

Product code	Input	SELV	Dimming	Bathroom zone	Products per driver
PSIP15024	220-240V	Yes	Yes (with PDCINT 1-10V)	N/A	1-6
LSD12024	220-240V	Yes	No	Outside zones	1 to 4
PSIP25024	220-240V	Yes	No	0	1-10

Accessories

JB5	Gel filled waterproof connector	Sold Separately	212
-----	---------------------------------	-----------------	------------

Feature Lights

IP68

IP68 suitable for full submersion into water

IK08

IK08 for protection against high impact



Suitable for coastal C5 and high acid and alkali environment

Guarantee

5 years

Features & benefits

316 Stainless steel housing and titanium cover provides outstanding corrosion resistance

Clear but strong 8mm tempered glass cover provides high efficiency and clear colour accuracy

TRIAC mains dimmable as standard with RGBW option

Pre-wired with 5 metres of cable to aid the installer

To be installed under water to prevent over-heating

1 1/2" BSP thread enables installation onto fabricated pipework

RGBW version available

Beam angle: 35°

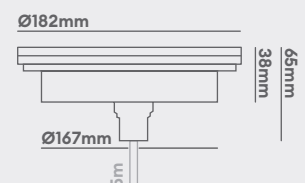
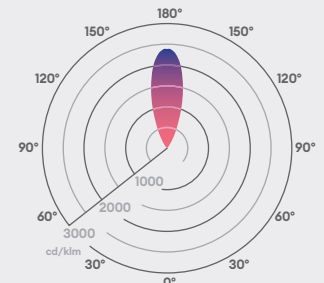

Wall Lights

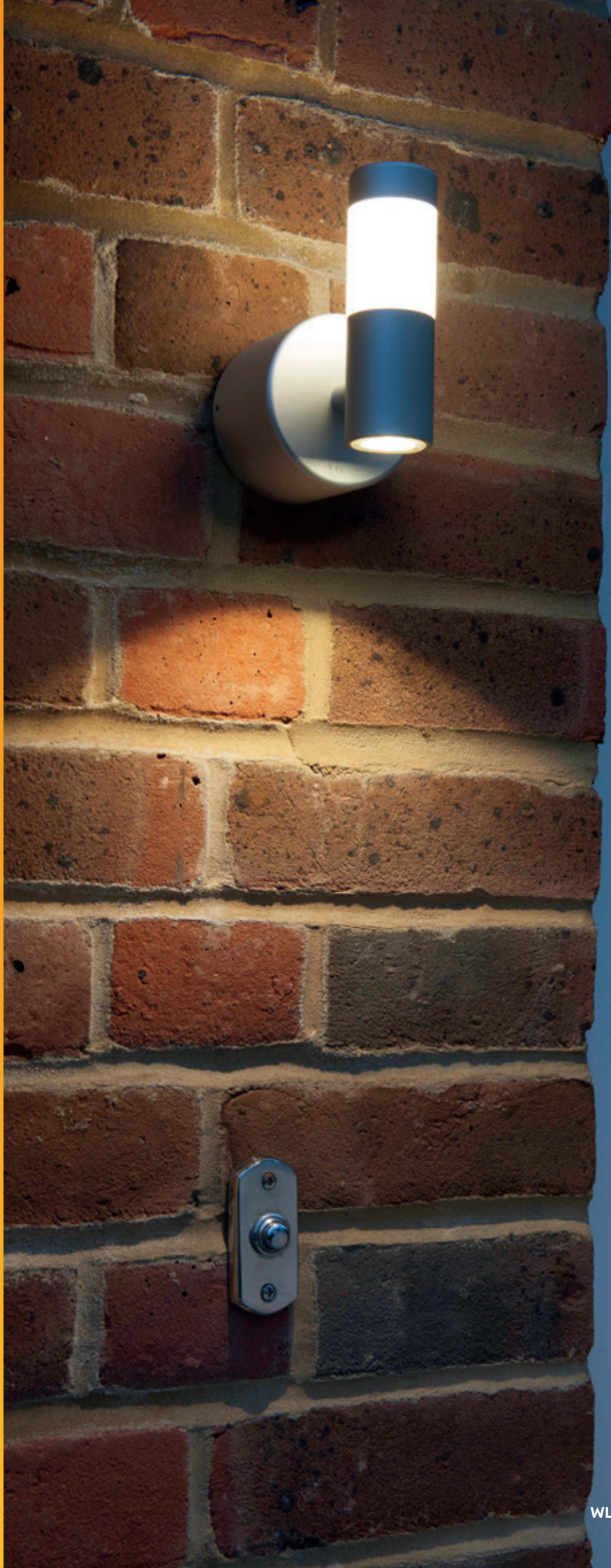

Wall lights

To create secure and adventurous spaces

Wall lights provide security as well as atmospheric and decorative lighting. Available in a range of styles and finishes, choose the perfect solution for your installation.

Choose your effect and how to create it

Highlight architecture or illuminate an entrance with Collingwood wall lights. The images below illustrate how your choice of lighting creates different effects.

Choose your effect:



Create it using:

WL070

This up / down light produces a narrow and concentrated beam of light up and downwards. This is used most effectively in situations where there is a great deal of height to fully appreciate the effect of the columns of light. As a result, these fittings are great for framing doors and windows.



WL075

The narrow and intense beam of light from this fitting will enhance the texture of the surface upon which it is mounted. This product works well on uneven stone and provides plenty of contrast between areas of light and shade.



Premium finishes

Available in a range of stylish finishes such as anodised aluminium and antique brass, our powerful WL220 wall lights also sport an attractive single point source LED, maximising the look and feel of the luminaires without compromising on performance. Alongside our ultra-premium solid brass finish, we've updated our range to include stainless steel 316 and anodised bronze, giving you even more choice when designing your installation.



Framing Vs feature lighting

With several styles and finishes available, we have the solution that creates the perfect lighting effect for your installation. Types of light effects to consider are:

Wall grazing



WL175A

Directional



WL220

Decorative



WL060

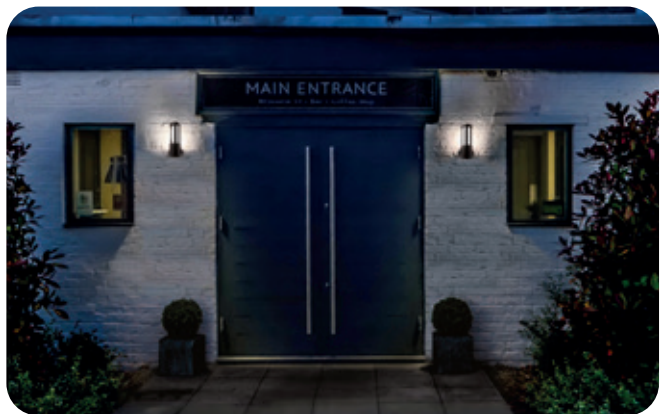

WL060

This fitting provides a diffused decorative light from its top and a broad spread of down light which will light the threshold of a doorway. This fitting will also ensure both comfort and safety are accommodated in addition to highlighting any decorative planting positioned below.



WL012

This fitting provides a broad spread of light from the diffused window design. This makes it suitable for general illumination for entrance areas.



Height of wall lights

A general rule of choosing the correct height and position for wall lights is 1650mm from floor or ground level (eye level to a person of 5ft 8in height.)

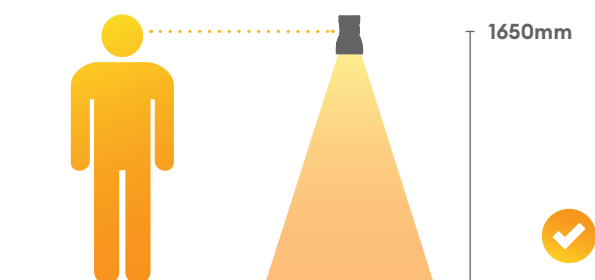

Light positioning

To avoid hot spots when using up/down lights to frame doors and windows, ensure that they are not positioned too closely to the ceiling or other horizontal surfaces.

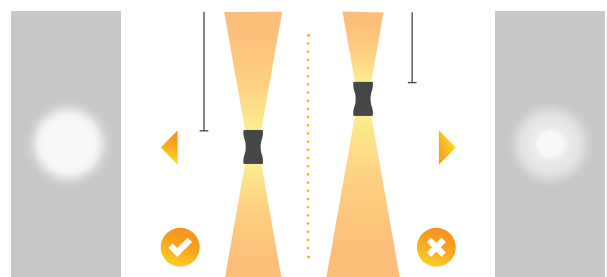





WL070

Black straight to mains, high output LED wall light

Features

IP rating	IP65
CSP switchable	Single CCT
Tiltable	No
Dimmable	No
Input	220-240V AC
LED lifetime	L70 70,000h
Colour rendering Index	CRI>80
Colour consistency	SDCM3

Installation information

Bathroom zone	2
Inrush current	60A 0.037ms
Construction material	Anodised aluminium,
Suitable for coastal areas	Yes
Weight	0.9kg
Maximum ambient temperature	40°C
SELV	Yes
Electric class (1, 2, 3)	1
Earth leakage	0.1mA

Photometrics @ 25°C

Product code	Finish	W	CCT	∠	lm	lm/W	Energy
WL070BNBM27	Black	5.1W	2700K	12°	510 / 255	100	
WL070BNBM30	Black	5.1W	3000K	12°	550 / 275	108	
WL070SNBM27	Silver	5.1W	2700K	12°	510 / 255	100	
WL070SNBM30	Silver	5.1W	3000K	12°	550 / 275	108	

Energy rating is a reflection of the LED light source.

Wiring information

Cable / flying lead	0.3m
Type of wiring required	Parallel

Accessories

N/A (No Accessories required)

Wall Lights

5.1W

5.1W



Coastal protected

IP65

IP65 ideal for outdoor environments

Guarantee

7 years

Features & benefits

Single LED and lens combination for maximum efficiency and optimal light distribution.

Ideal for framing entrances and illuminating columns with its bi-directional lights

Anodised Aluminium is sleek and durable

Long lifetime of 70,000hrs

Mains voltage wall light

Beam angle: 12°

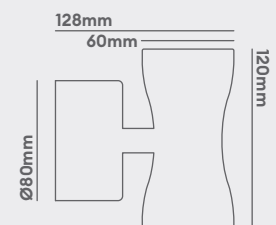
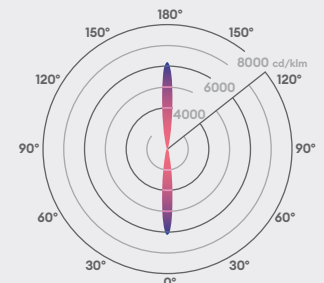

Wall Lights

5.7W 5.7W



Coastal protected



Adjustable LED fitting

Guarantee

7 years

Features & benefits

Straight to mains

IP65 ideal for outdoor environments

Improved look and feel with single LED

Adjustable head allows for quick changes in direction light to suit any installation.

Available in an array of colours Antique Brass, Black, Bronze, Copper, and Stainless Steel

Beam angle: 40°

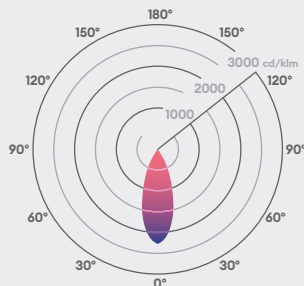

145mm

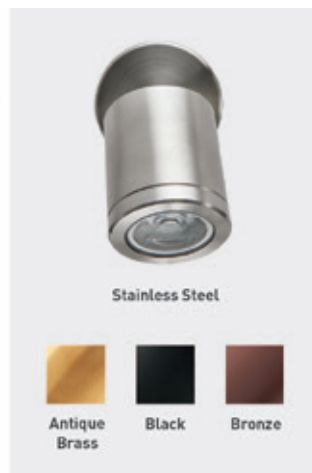
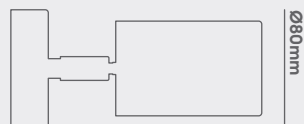

WL220

Straight to mains LED wall light

Features

IP rating	IP65
CSP switchable	Single CCT
Tiltable	90°
Input	220-240V AC
LED lifetime	L70 70,000h
Colour rendering Index	CRI>80
Colour consistency	SDCM3

Installation information

Inrush current	0.07ms 5.2A
Construction material	Stainless Steel 316
Suitable for coastal areas	Yes
Weight	WL220AB: TBC, WL220SS: 1000g, WL220BK: 500g, WL220BZ: 500g
Maximum ambient temperature	35°C
SELV	Yes
Electric class (1, 2, 3)	1
Earth leakage	0.1mA

Photometrics @ 25°C

Product code	Finish	W	CCT	∠	lm	lm/W	Energy
WL220SS22MF	Stainless steel 316	5.7W	2200K	40°	431	76	
WL220SS22MS	Stainless steel 316	5.7W	2200K	40°	431	76	
WL220SS27MF	Stainless steel 316	5.7W	2700K	40°	515	90	
WL220SS27MS	Stainless steel 316	5.7W	2700K	40°	515	90	
WL220SS30MF	Stainless steel 316	5.7W	3000K	40°	520	91	
WL220SS30MS	Stainless steel 316	5.7W	3000K	40°	520	91	
WL220SS40MF	Stainless steel 316	5.7W	4000K	40°	538	94	
WL220SS40MS	Stainless steel 316	5.7W	4000K	40°	538	94	

In the part code to replace your colour, change SS to AB (Antique Brass), BK (Black) or BZ (Bronze). **Important:** AB finish is made to order. Energy rating is a reflection of the LED light source.

Wiring information

Cable / flying lead	0.3m
Type of wiring required	Parallel

Accessories

GH220	Simple hood to reduce glare whilst maintaining a good light distribution	Sold Separately	89
GS220	Simple hood to reduce glare whilst maintaining a good light distribution	Sold Separately	89



WL075

Black straight to mains, high output LED wall light

Features

IP rating	IP65
CSP switchable	Single CCT
Tiltable	No
Dimmable	No
Input	220-240V AC
LED lifetime	L70 70,000h
Colour rendering Index	CRI>80
Colour consistency	SDCM3

Installation information

Bathroom zone	2
Inrush current	60A 0.037ms
Construction material	Anodised aluminium
Suitable for coastal areas	Yes
Weight	1.2kg
Maximum ambient temperature	40°C
SELV	Yes
Electric class (1, 2, 3)	1
Earth leakage	0.1mA

Photometrics @ 25°C

Product code	Finish	W	CCT	∠°	lm	lm/W	Energy
WL075BNBM27	Black	5.7W	2700K	110°	515	90	
WL075BNBM30	Black	5.7W	3000K	110°	520	91	
WL075SNBM27	Silver	5.7W	2700K	110°	515	90	
WL075SNBM30	Silver	5.7W	3000K	110°	520	91	
WL075ZNBM27	Bronze	5.7W	2700K	110°	515	90	
WL075ZNBM30	Bronze	5.7W	3000K	110°	520	91	

Energy rating is a reflection of the LED light source.

Wiring information

Cable / flying lead	0.3m
Type of wiring required	Parallel

Accessories

N/A (No Accessories required)

Wall Lights

5.7W 5.7W

Coastal protected

IP65 IP65 ideal for outdoor environments

Guarantee

7 years

Features & benefits

Single LED and lens combination for maximum efficiency and optimal light distribution.

Straight to mains wall light, perfect for framing entrances and illuminating columns

Anodised Aluminium is sleek and durable

Long lifetime of 70,000hrs

Beam angle: 110°

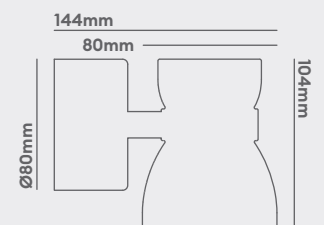
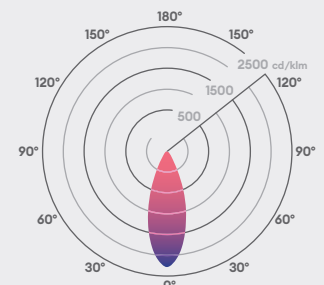

Wall Lights

2.6W 2.6W



Coastal protected

IP65

IP65 ideal for outdoor environments

Guarantee

7 years

Features & benefits

Bi-directional wall light offering decorative halo effect and functional downward flood light

Complete with wall fixings and waterproof crimp connectors

Mains voltage wall light



WL060 | WL160

Straight to mains LED halo / flood wall light

Features

IP rating	IP65
CSP switchable	Single CCT
Tilttable	No
Dimmable	No
Input	220-240V AC
LED lifetime	L70 70,000h
Colour rendering Index	CRI>80
Colour consistency	SDCM3

Installation information

Bathroom zone	2
Inrush current	9A 0.8ms
Construction material	Anodised aluminium
Suitable for coastal areas	Yes
Weight	0.6kg
Maximum ambient temperature	40°C
SELV	Yes
Electric class (1, 2, 3)	1
Earth leakage	0.1mA

Photometrics @ 25°C

Product code	Finish	W	CCT	∠	lm	lm/W	Energy
WL060 NW	Silver	2.6W	4000K	120°	82	32	A
WL060 WW	Silver	2.6W	3000K	120°	58	22	A
WL160 27	Black	2.6W	2700K	120°	56	22	A
WL160 NW	Black	2.6W	4000K	120°	82	32	A
WL160 WW	Black	2.6W	3000K	120°	58	22	A

Energy rating is a reflection of the LED light source.

Wiring information

Cable / flying lead	0.3m
Type of wiring required	Parallel

Accessories

N/A (No Accessories required)

Beam angle: 120°

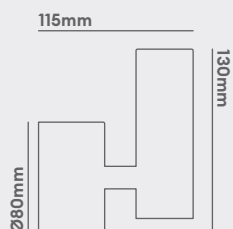
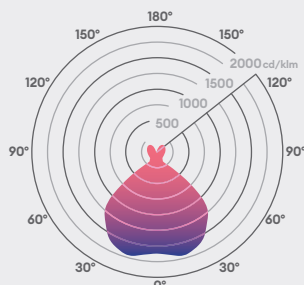



WL012

IP54, 610lm straight to mains wall light

Features

IP rating	IP54
CSP switchable	Single CCT
Tilttable	
Dimmable	No
Input	220-240V AC
LED lifetime	L70 30,000h
Colour rendering Index	CRI>80
Colour consistency	SDCM5

Installation information

Bathroom zone	N/A
Inrush current	20A 0.5ms
Construction material	Powder coated aluminium
Suitable for coastal areas	No
Weight	1kg
Maximum ambient temperature	40°C
SELV	Yes
Electric class (1, 2, 3)	1
Earth leakage	0.1mA

Photometrics @ 25°C

Product code	Finish	W	CCT	∠	lm	lm/W	Energy
WL012G30	Grey RAL7022	11.0W	3000K	338°	610	55	
WL012X30	Black RAL9011	11.0W	3000K	338°	610	55	

Energy rating is a reflection of the LED light source.

Wiring information

Cable / flying lead	N/A
Type of wiring required	Parallel

Accessories

N/A (No Accessories required)

Wall Lights

11W

11W



Integral bracket for easy installation

IP54

IP54 ideal for framing doorways and entrances

Guarantee

5 years

Features & benefits

Straight to mains screw terminals

Durable powder coated aluminium in contemporary black or grey finish

Provides a good light level for safe navigation at night

Wide light distribution with 360° beam angle

Beam angle: 338°

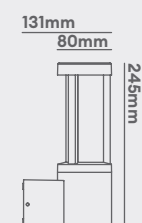
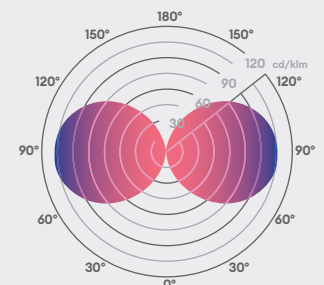

Decorative Lighting







WL041IP

Straight to mains, fan effect LED wall light

Features

IP rating	IP65
CSP switchable	Single CCT
Tilttable	No
Rotatable	No
Dimmable option	No
Input	220-240V AC
LED lifetime	L70 70,000h
Colour rendering Index	CRI>80
Colour consistency	SDCM3

Installation information

Cut out size (mm)	N/A
Bathroom zone	2
Inrush current	9A 0.8ms
Construction material	Anodised aluminium
Weight	0.3kg
Maximum ambient temperature	35°C
Electric class (1, 2, 3)	1

Photometrics @ 25°C

Product code	Finish	W	CCT	lm	lm/W	Energy
WL041 IP WW	Silver	1.6W	3000K	33	21	

Energy rating is a reflection of the LED light source.

Wiring information

Cable / flying lead	0.3m
Type of wiring required	Parallel

Accessories

N/A (No Accessories required)

Decorative Lighting

1.6W 1.6W

Coastal protected

IP65 IP65 ideal for outdoor environments

Guarantee

7 years

Features & benefits

Unique radial appearance creates a decorative lit effect on surrounding surfaces

Straight to mains for easy installation

Complete with bracket and waterproof crimp connectors

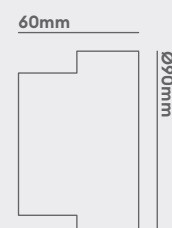
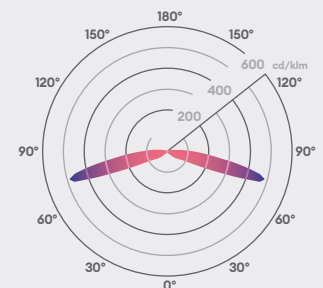

Decorative Lighting



Coastal protected

1W

1W at 350mA

IP68

IP68 ideal for outdoor areas and extreme weather

Guarantee

7 years

Features & benefits

Small & discreet decorative recessed LED light

Perfect for discreet decorative light in interior and exterior applications



ML01

Decorative LED mini light

Features

IP rating	IP68
CSP switchable	Single CCT
Tilttable	No
Rotatable	No
Dimmable option	Driver dependent
Input	350mA
LED lifetime	L70 70,000h
Colour rendering Index	CRI>80
Colour consistency	SDCM3

Installation information

Cut out size (mm)	26
Bathroom zone	0
Inrush current	N/A
Construction material	Stainless steel (316)
Weight	50g
Maximum ambient temperature	35°C
Electric class (1, 2, 3)	3

Photometrics @ 25°C

Product code	Finish	W	CCT	lm	lm/W	Energy
ML01 27	Silver	1W	2700K	3.5	3.5	
ML01 WW	Silver	1W	3000K	3.6	3	
ML01 NW	Silver	1W	4000K	4	4	

Energy rating is a reflection of the LED light source.

Wiring information

Cable / flying lead	1m (0.205mm ² red & black PTFE)
Type of wiring required	Series

Recommended LED drivers

See pages 200 - 203 for complete LED driver offer

Product code	Input	SELV	Dimming	Bathroom zone	Products per driver
DRV350700TD (350 & 500mA)	220-240V	Yes	Yes	N/A	4-14
PSIP3509W	220-240V	Yes	No	0	1-8

Accessories

UY2 CONNECTOR	Quick waterproof connector	Sold Separately	213
---------------	----------------------------	-----------------	-----

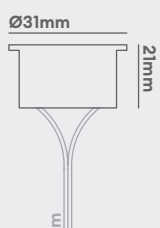
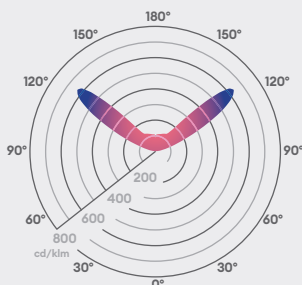



LED LYTE IP

IP rated mini LED light

Features

IP rating	IP65
CSP switchable	Single CCT
Tilttable	No
Rotatable	No
Dimmable option	Driver dependent
Input	350mA
LED lifetime	L70 70,000h
Colour rendering Index	CRI>80
Colour consistency	SDCM3

Installation information

Cut out size (mm)	26
Bathroom zone	1
Inrush current	N/A
Construction material	Anodised aluminium
Weight	44g
Maximum ambient temperature	35°C
Electric class (1, 2, 3)	3

Photometrics @ 25°C

Product code	Finish	W	CCT	∠	lm	lm/W	Energy
LED LYTE IP 27	Silver	1W	2700K	110°	58	58	
LED LYTE IP NW	Silver	1W	4000K	110°	82	82	
LED LYTE IP WW	Silver	1W	3000K	110°	63	63	

Energy rating is a reflection of the LED light source.

Wiring information

Cable / flying lead	1m (0.205mm ² red & black PTFE)
Type of wiring required	Series

Recommended LED drivers

See pages 200 - 203 for complete LED driver offer

Product code	Input	SELV	Dimming	Bathroom zone	Products per driver
DRV350700TD (350 & 500mA)	220-240V	Yes	Yes	N/A	4-14
PSIP3509W	220-240V	Yes	No	1	1-8

Accessories

LED LYTE 1M EXT	1m Plug & Play extension lead	Sold Separately	119
LED LYTE 6 WAY EXT	6-way 1m Plug & Play extension lead	Sold Separately	119

Decorative Lighting



Quick and easy installation with plug and play connector



Coastal protected



IP65 ideal for outdoor areas

Guarantee

7 years

Features & benefits

Small & discreet

Ideal for decorative lighting

Beam angle: 110°

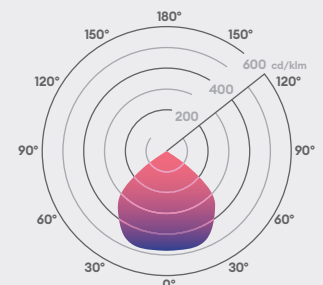

Ø30mm

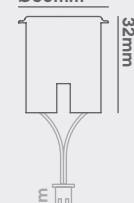

Decorative Lighting



Quick and easy installation with plug and play connector



Coastal protected



IP65 ideal for outdoor areas

Guarantee

7 years

Features & benefits

Small & discreet

Thread and nut for secure fitting



LED LYTE IP T

IP rated threaded mini LED light

Features

IP rating	IP65
CSP switchable	Single CCT
Tilttable	No
Rotatable	No
Dimmable option	Driver dependent
Input	350mA
LED lifetime	L70 70,000h
Colour rendering Index	CRI>80
Colour consistency	SDCM3

Installation information

Cut out size (mm)	26
Bathroom zone	1
Inrush current	N/A
Construction material	Anodised aluminium
Weight	44g
Maximum ambient temperature	35°C
Electric class (1, 2, 3)	3

Photometrics @ 25°C

Product code	Finish	W	CCT	∠	lm	lm/W	Energy
LED LYTE IP T NW	Silver	1W	4000K	110°	82	82	

Energy rating is a reflection of the LED light source.

Wiring information

Cable / flying lead	1m (0.205mm ² red & black PTFE)
Type of wiring required	Series

Recommended LED drivers

See pages 200 - 203 for complete LED driver offer

Product code	Input	SELV	Dimming	Bathroom zone	Products per driver
DRV350700TD (350 & 500mA)	220-240V	Yes	Yes	N/A	4-14
PSIP3509W	220-240V	Yes	No	1	1-8

Accessories

LED LYTE 1M EXT	1m Plug & Play extension lead	Sold Separately	119
LED LYTE 6 WAY EXT	6-way 1m Plug & Play extension lead	Sold Separately	119

Beam angle: 110°

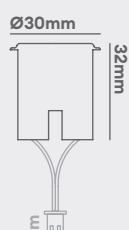
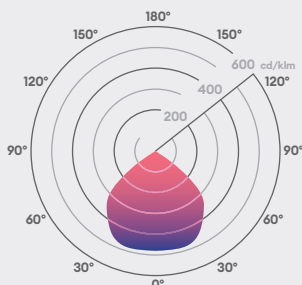

LED Lyte accessories

Choose the ideal cable for LED Lyte

Connect your LED Lyte to a PLU/PP/350 1-9 driver.

Choose the ideal cable



Accessory on its own

Product codes

Product Code	Description	Cable / flying lead	Guarantee
LED LYTE 1M EXT	1m extension lead (plug & play)	1m (0.205mm ² red & black PTFE)	1 year extended warranty
LED LYTE 6 WAY EXT	6-way 1m extension lead lead (plug & play)	1m (0.205mm ² red & black PTFE)	1 year extended warranty

Compatible with

	LED Lyte IP Page 117	LED Lyte IPT Page 118
LED LYTE 1M EXT	●	●
LED LYTE 6 WAY EXT	●	●

Bollards





Bespoke wooden bollards

Purpose built in Great Britain, for your installation

Adding style and flair to any design scheme, bollards can add depth and dimension to a landscape, creating safer, 24-hour spaces.

Single LED bollard

Use the single LED bollard to add new lighting to existing pathways, gardens or shared spaces. The remote SELV power supply provides increased flexibility when fitting. Long distances of cable can be concealed within trunking. Bollards are often purposely positioned in a uniformed capacity to highlight a walkway; however, they can also be integrated into a landscape feature, maximising the overall design of the space.



For a pathway with consistent points highlighted:

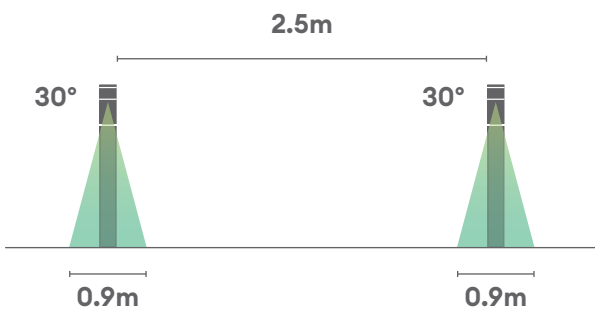

Triple LED bollard

Using an integral power supply, this direct to mains bollard is ideal for replacing existing bollard lighting, which may be looking tired or in need of replacement. It is easy to retrofit using existing cables or as part of a new build, where cables can easily be installed with minimum impact. Using three LEDs instead of one and with a wider beam angle, these products are capable of being positioned at greater distances whilst still creating an even spread of light.



For a pathway consistently lit at 30 lux:

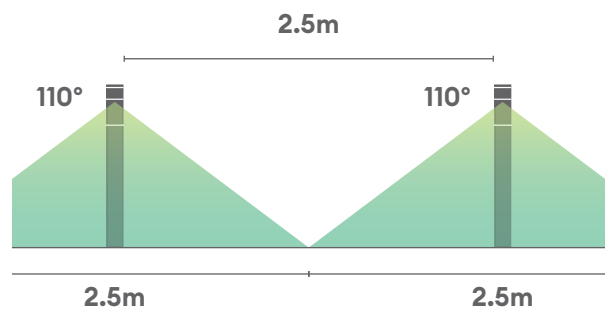

Choice of material

Choose from three beautifully crafted woods to obtain the ideal aesthetic for your bollard.

Iroko



Oak



Sapele



Choice of style

Choose from three unique styles to suit your installation.

Domed



Chamfered



Pointed



Colour temperature

Choose between three available colour temperatures.

2700K



3000K



4000K



Single lighting regulations

We are making the wooden bollards more serviceable. The change is a simple one with beneficial impact: there will be a removable back plate so that the control gear and light modules can be accessed and replaced if necessary. On bottom cable entry, the panel goes all the way to the floor, with three brass countersunk screws holding it in place, and the side entry models has the removable plate up to the cable entry.

Choosing the ideal wooden bollard

For your installation

Use the five easy steps below to ascertain the perfect bollard for your installation.

Do you need a bollard with single or triple LEDs?

Single LED bollard

Beam angle : 30°



Triple LED bollard

Beam angle : 110°



Which style head would you like?

Domed



Chamfered



Pointed



Which type of wood do you prefer?

Iroko



Oak



Sapele



Will the bollard be recessed or surface mounted?

Recessed mount

Side cable entry is required for recess mounting.



Surface mount

Base cable entry is required for surface mounting.



When surface mounting you will also need a bracket.



Product code:
BOL LED BRACKET

Which colour temperature do you need?

Warmest

For a warm cosy look use 2700K.



Warmest

For a warm cosy look use 2700K.



Warmest

For a warm cosy look use 2700K.



Now you've determined what you'll need, use the product code generator on the next page to obtain the correct product code.

Choosing the ideal wooden bollard

For your installation

Now that you know what attributes you want, use the matrix below to work out which product code you will need.

Use the generator below to build your wooden bollards product code based on the attributes you have selected

The example shown is for a single LED with base cable entry, 2700K, iroko wood, domed head bollard, resulting in the partcode BL01DIB27. You can change each element to represent the bollard you need.

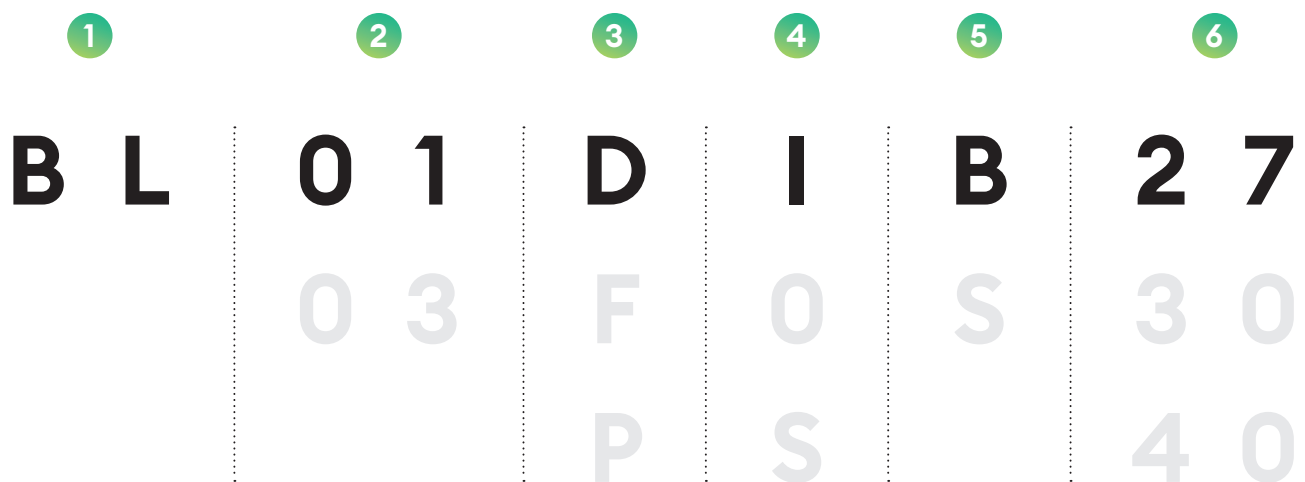

1 Product type

BL Bollard

2 Single / Triple LED

01 Single LED

03 Triple LED

3 Style

D Domed

F Chamfered

P Pointed

4 Material

I Iroko wood

O Oak wood

S Sapele wood

5 Cable entry

B Base entry

S Side entry

6 Colour temperature

27 2700K

30 3000K

40 4000K



Bollards

1W 1W at 350mA or 700mA

 Coastal Protected

IP65 IP65 ideal for outdoor areas

Guarantee

7 Years

Features & benefits

Choice of wood finishes: Iroko, Sapele or Oak

Pointed, Chamfered or Domed top

Choice of low-voltage or straight-to-mains

Side-entry cable or base-entry cable options

Three colour temperature options: 2700K, 3000K or 4000K

7-year warranty

Beam angle: 26°

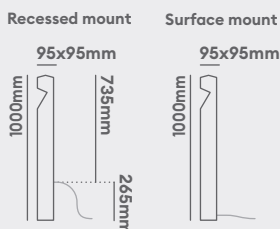
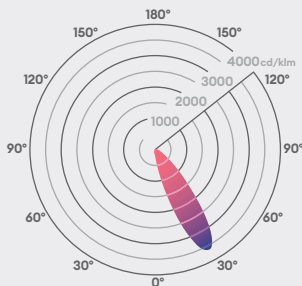

BL01

Low voltage



Features

IK rating	N/A
IP rating	IP65
CSP switchable	Single CCT
Input	350mA / 700mA
LED lifetime	L70 70,000h
Colour rendering Index	CRI>80
Colour consistency	SDCM3

Installation information

Inrush current	N/A
Construction material	See page 256-257
Suitable for coastal areas	Yes (with appropriate treatment)
Weight	5800g
Maximum ambient temperature	35°C
SELV	
Electric class (1, 2, 3)	3
Earth leakage	N/A

Photometrics @ 25°C

Product code	CCT	∠°	350mA			700mA			Energy
			W	lm	lm/W	W	lm	lm/W	
See page 124	2700K	26°	1W	70	70	2W	337	60	
	3000K	26°	1W	75	75	2W	379	68	
	4000K	26°	1W	95	95	2W	393	70	

Energy rating is a reflection of the LED light source.

Wiring information

Cable / flying lead	1.8m (H05RN-F) rubberised cable (outside diameter: 6mm)
Type of wiring required	Series

Recommended LED drivers

See pages 200 - 203 for complete LED driver offer

Product code	Input	SELV	Dimming	Bathroom zone	Products per driver
DRV150700 (all settings)	220-240V	Yes	No	N/A	1-14
DRV350700TD (350 & 500mA)	220-240V	Yes	Yes	N/A	4-9

Accessories

BOL LED BRACKET	Stainless steel bracket for BOL LED range	Sold Separately	128
JB2 / JB4 / JB6	Waterproof junction box / Gel filled waterproof connectors	Sold Separately	212
WCR 275 BLACK	2-core rubber cable	Sold Separately	213



BL03

Straight to mains

Features

IK rating	N/A
IP rating	IP65
CSP switchable	Single CCT
Input	220-240V AC
LED lifetime	L70 70,000h
Colour rendering Index	CRI>80
Colour consistency	SDCM3

Installation information

Inrush current	60A 0.037ms
Construction material	See page 256-257
Suitable for coastal areas	Yes (with appropriate treatment)
Weight	5500g
Maximum ambient temperature	35°C
SELV	Yes
Electric class (1, 2, 3)	2
Earth leakage	0.1mA

Photometrics @ 25°C

Product code	W	CCT	∠	lm	lm/W	Energy
See page 124	5W	2700K	110°	156	31	
	5W	3000K	110°	160	32	
	5W	4000K	110°	246	49	

Energy rating is a reflection of the LED light source.

Wiring information

Cable / flying lead	NEW 1.5mm SY 2 Core PVC Steel Braid Cable. 2M Length.
Type of wiring required	Parallel

Accessories

BOL LED BRACKET	Stainless steel bracket for BOL LED range	Sold Separately	128
JB5	Gel filled junction box	Sold Separately	212

Bollards

5W 5W at 350mA or 700mA

Coastal Protected

IP65 IP65 ideal for outdoor areas

Guarantee

7 Years

Features & benefits

- Choice of wood finishes: Iroko, Sapele or Oak
- Pointed, Chamfered or Domed top
- Choice of low-voltage or straight-to-mains
- Side-entry cable or base-entry cable options
- Three colour temperature options: 2700K, 3000K or 4000K
- 7 year warranty

Beam angle: 110°

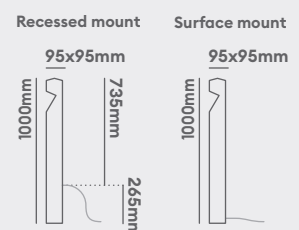
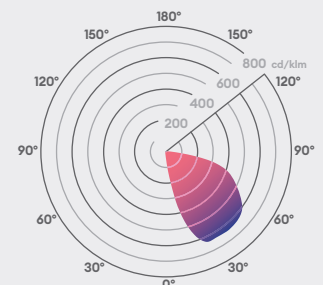

Bollard accessories

Get a mounting bracket

When mounting your bollard onto a solid surface get a mounting bracket.

Use a mounting bracket

BOL LED BRACKET

Accessory on its own



Accessory on product



Product codes

Product Code	Description	Construction material	Guarantee
BOL LED BRACKET	Stainless steel bracket for wooden bollard range	Stainless steel (304)	1 year extended warranty

For full product specification visit collingwoodlighting.com

Compatible with

BLO1
Page 126

BLO3
Page 127

BOL LED BRACKET



Flexible bollards

Wide choice to suit your application

Adding style and flair to any design scheme, bollards can add depth and dimension to a landscape, creating safer, 24-hour spaces.

Head options

Two broad styles are available to suit the majority of applications. The head options produce divergent lit effects and should be selected with the end result in mind.

General illumination

Ideal for general illumination of an area. The broad spread of light means that it is suitable for illuminating and marking paths, walkways as well as general area lighting.

BOL10



BOL20



Low glare

The low glare design has minimal upwards spill-light beyond 90°, maximising the efficiency of the lit effect and increasing visual comfort.

BOL30



Height options

Available in two heights, each of the bollards have a full-height and a half-height option, providing the perfect solution for any installation.

Half-height

A more discreet option whilst also having a greater intensity of light at ground level.



Full-height

A more prominent option that is tall enough to provide light over obstacles such as shrubbery.



Root mount

The root mounting kit is ideal for when a bollard is mounted into concrete. They simply attach to the bottom and anchor the bollard into place.



Colour switchable (Slim CSP)

CCT switchable: one light, three CCT temperatures

Our range of colour switchable bulkheads allows you to stock 3 colour temperatures in 1 product (2700K, 3000K & 4000K).

Advantages

- Simpler product range.
- Products can be adjusted after they are installed.

Choice of finish & size

Choose the ideal colour and size for your installations.

Slim CSP is available in 300mm or 600mm height, with a choice of 3 colour finishes, black, anthracite and corten.



Black



Anthracite



Corten

Flexible bollards

Bollard light distribution

The three bollard families have a different distribution of light according to their different styles, and is also affected by the bollard height. See below for a handy overview of the spacing between the bollards in order to achieve a consistent light level of 20lux, perfect for a typical pathway.

BOL100

Midi 350mm high bollard with 360° illumination

2m at 20lux

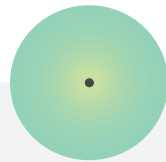

For a pathway consistently lit at 20 lux:



BOL101

Midi 650mm high bollard with 360° illumination

2m at 20lux

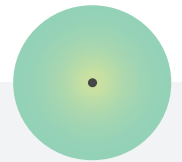

For a pathway consistently lit at 20 lux:

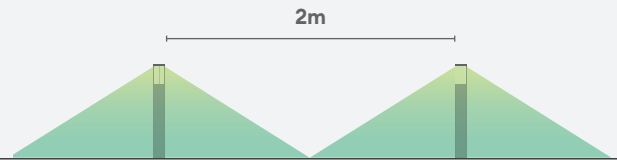

BOL200

Midi 500mm high bollard with 360° illumination

2.35m at 20lux

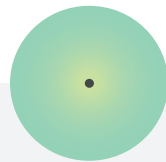

For a pathway consistently lit at 20 lux:

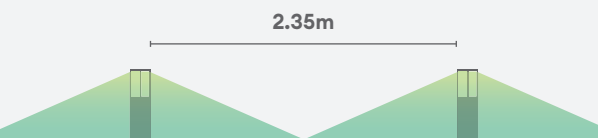

BOL201

Midi 900mm high bollard with 360° illumination

2.6m at 20lux

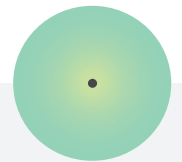

For a pathway consistently lit at 20 lux:

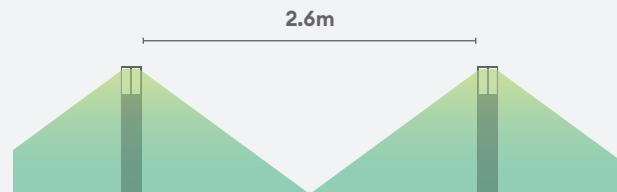

BOL200

Midi 500mm high bollard with 360° illumination

2.65m at 20lux

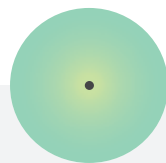

For a pathway consistently lit at 20 lux:

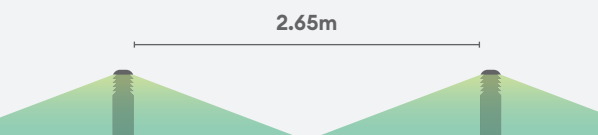

BOL201

Midi 900mm high bollard with 360° illumination

3m at 20lux

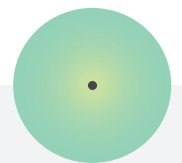

For a pathway consistently lit at 20 lux:

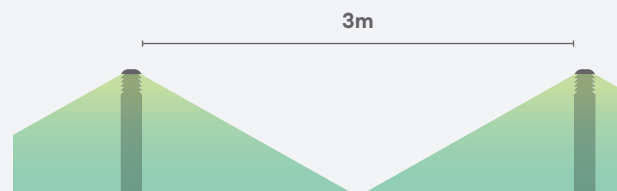



BOL100 Midi Post Light

Straight to mains IP54, 610lm post light

Features

IK rating	IK04
IP rating	IP54
CSP switchable	Single CCT
Input	220-240V AC
LED lifetime	L70 30,000h
Colour rendering Index	CRI>80
Colour consistency	SDCM4

Installation information

Inrush current	20A
Construction material	Aluminium / PVC
Suitable for coastal areas	No
Weight	BOL100: 1.2kg BOL101: 1.5Kg
Maximum ambient temperature	40°C
SELV	Yes
Electric class (1, 2, 3)	1
Earth leakage	0.1mA

Photometrics @ 25°C

Product code	Finish	Height	W	CCT	∠°	lm	lm/W	Energy
BOL100X30	Black RAL9011	350mm	11W	3000K	360°	610	55	
BOL101X30	Black RAL9011	650mm	11W	3000K	360°	610	55	

Energy rating is a reflection of the LED light source.

Wiring information

Cable required for connector	3x 1.0mm ²
Type of wiring required	Parallel

Accessories

JB5	Waterproof junction box / Gel filled waterproof connectors	Sold Separately	212
-----	--	-----------------	-----

Bollards

11W 11W

IP54 IP54 ideal for walk ways and step lighting

360° Benefiting from light all round with a 360° beam angle

Guarantee

5 years

Features & benefits

Straight to mains screw terminals

Ideal for residential landscape projects, such as lighting low level shrubs

Ideal to light up car parking spaces and driveways

High lumen output of 610lm

Great for soft illumination onto stone paths

Black RAL 9011

Beam angle: 360°

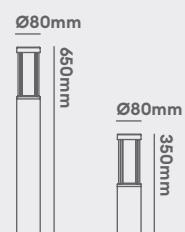
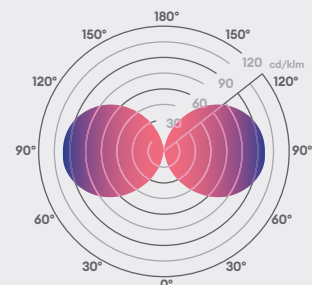

Bollards

23W 23W

IP65 IP65 ideal for car parks and walk ways

360° Benefiting from light all round with a 360° beam angle

Guarantee

5 years

Features & benefits

Straight to mains screw terminals

Comes complete with root mounting kit

Low glare illumination, ideal for pathways, boundary marking, or general illumination of exterior spaces

High lumen output of 930lm

Black RAL 9011

Beam angle: **360°**

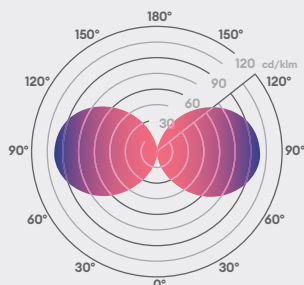

Ø145mm



BOL201 Bollard

Straight to mains, IP65, 930lm bollard

Features

IK rating	IK04
IP rating	IP65
CSP switchable	Single CCT
Input	220-240V AC
LED lifetime	L70 30,000h
Colour rendering Index	CRI>80
Colour consistency	SDCM4

Installation information

Inrush current	20A 0.5ms
Construction material	Aluminium / PVC
Suitable for coastal areas	No
Weight	BOL200: 4.4Kg BOL201: 4.4Kg
Maximum ambient temperature	40°C
SELV	Yes
Electric class (1, 2, 3)	1
Earth leakage	0.2mA

Photometrics @ 25°C

Product code	Finish	Height	W	CCT	Beam angle	lm	lm/W	Energy
BOL201X30	Black RAL9011	900mm	23W	3000K	360°	930	40	

Energy rating is a reflection of the LED light source.

Wiring information

Cable required for connector	3x 1.0mm ²
Type of wiring required	Parallel

Accessories

JB5	Waterproof junction box / Gel filled waterproof connectors	Sold Separately	212
------------	--	-----------------	------------



BOL300 Midi Bollard

Straight to mains, IP65, 500lm bollard

Features

IK rating	IK08
IP rating	IP65
CSP switchable	Single CCT
Input	220-240V AC
LED lifetime	L70 30,000h
Colour rendering Index	CRI>80
Colour consistency	SDCM4

Installation information

Inrush current	20A
Construction material	Aluminium / PVC
Suitable for coastal areas	No
Weight	BOL300: 2.9Kg BOL301: 2.9Kg
Maximum ambient temperature	40°C
SELV	Yes
Electric class (1, 2, 3)	1
Earth leakage	0.2mA

Photometrics @ 25°C

Product code	Finish	Height	W	CCT	Beam angle	lm	lm/W	Energy
BOL300X30	Black RAL9011	500mm	23W	3000K	360°	500	22	
BOL301X30	Black RAL9011	900mm	23W	3000K	360°	500	22	

Energy rating is a reflection of the LED light source.

Wiring information

Cable required for connector	3x 1.0mm ²
Type of wiring required	Parallel

Accessories

JB5	Waterproof junction box / Gel filled waterproof connectors	Sold Separately	212
-----	--	-----------------	-----

Bollards

23W 23W

IP65 IP65 ideal for car parks and walk ways

360° Benefiting from light all round with a 360° beam angle

Guarantee

5 years

Features & benefits

Straight to mains screw terminals

Domed top for a low glare finish, and a minimum up spill of light making it comfortable on the eye

IK08 rated

Black RAL 9011

Beam angle: 360°

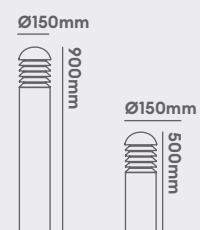
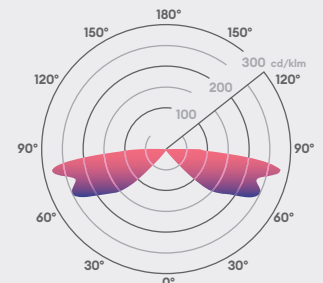

Bollards



Switchable between 2700K, 3000K and 4000K



360° even light distribution



IP65 ideal for car parks and walk ways

Guarantee

5 year warranty

Features & benefits

Choice of colours Black, Anthracite and Corten

Available in 300mm and 600mm sizes

Cable entry through base and expansion bolt installation kit included

IP68 inline connector included

Anthracite RAL 7016, Black RAL 9005

Beam angle: 120°

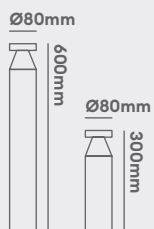
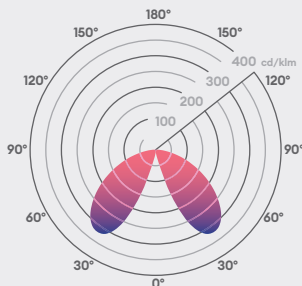

Slim CSP Bollard

CCT Switchable IP65 Bollard

Features

IK rating	IK08
IP rating	IP65
CSP switchable	Switchable CCT
Input	220-240V AC
LED lifetime	L80 100,000h
Colour rendering Index	CRI>80
Colour consistency	SDCM6

Installation information

Inrush current	10A 0.4ms
Construction material	Aluminum
Suitable for coastal areas	Yes
Weight	BLS_3RDCS: 1060g BLS_6RDCS: 1380g
Maximum ambient temperature	-15°C - 30°C
SELV	No
Electric class (1, 2, 3)	1
Earth leakage	0.032mA

Photometrics @ 25°C

Product code	Height	Finish	W	Colour	∠	Im	lm/W	Energy
BLSAG3RDCS	300mm	Anthracite	14W	2700K	120°	720	56	E
				3000K	120°	770	62	
				4000K	120°	800	58	
BLSAG6RDCS	600mm	Anthracite	14W	2700K	120°	720	56	E
				3000K	120°	770	62	
				4000K	120°	800	58	
BLSBK3RDCS	300mm	Black	14W	2700K	120°	630	50	E
				3000K	120°	660	53	
				4000K	120°	680	50	
BLSBK6RDCS	600mm	Black	14W	2700K	120°	630	50	E
				3000K	120°	660	53	
				4000K	120°	680	50	
BLSNC3RDCS	300mm	Corten	14W	2700K	120°	760	57	E
				3000K	120°	735	60	
				4000K	120°	675	55	
BLSNC6RDCS	600mm	Corten	14W	2700K	120°	760	57	E
				3000K	120°	735	60	
				4000K	120°	675	55	

Energy rating is a reflection of the LED light source.

Wiring information

Cable / flying lead	H05RN-F 3G 1.0mm ²
Cable required for connector	3x 0.75 - 2.5mm ²
Type of wiring required	Parallel

Accessories

SBEBX4	Root mount Kit, J-Bolts X4	Sold Separately
--------	----------------------------	-----------------



LUXI 650

Straight to mains bollard

Features

IK rating	IK06
IP rating	IP54
CSP switchable	Single CCT
Input	220-240V AC
LED lifetime	L70 50,000h
Colour rendering Index	CRI>80
Colour consistency	SDCM6

Installation information

Inrush current	N/A
Construction material	Cast Aluminium
Suitable for coastal areas	No
Weight	2,000
Maximum ambient temperature	-20°C - 40°C
SELV	No
Electric class (1, 2, 3)	1

Photometrics @ 25°C

Product code	Finish	W	CCT	∠°	lm	lm/W	Energy
OUI3824	Anthracite grey RAL7016	7W	3000K	30°	660	68	

Energy rating is a reflection of the LED light source.

Wiring information

Cable / flying lead	cable diameter for connection 12mm
Type of wiring required	Parallel

Accessories

N/A (No Accessories required)

Bollards

7W 7W

IP54 IP54 ideal for walk ways and step lighting

CRI>80 CRI 80 providing true colour appearance

Guarantee

3 years

Features & benefits

IK06 for robust impact protection

Great for soft illumination onto stone paths

Anthracite RAL 7016

Beam angle: 30°

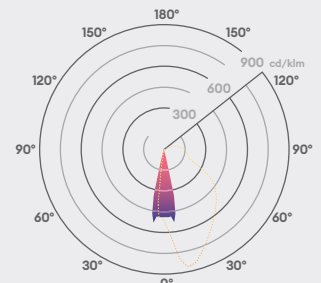

Ø90mm

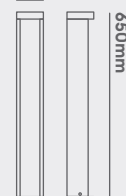





LUXI 54

Rectangular terminal bollard

Features

IK rating	IK08
IP rating	IP54
CSP switchable	Single CCT
Input	220-240V AC
LED lifetime	L70 50,000h
Colour rendering Index	CRI>80
Colour consistency	SDCM6

Installation information

Inrush current	N/A
Construction material	Aluminium
Suitable for coastal areas	No
Weight	2.130
Maximum ambient temperature	-20°C - 40°C
SELV	No
Electric class (1, 2, 3)	1

Photometrics @ 25°C

Product code	Finish	W	CCT	∠°	lm	lm/W	Energy
OUI3624	Anthracite grey RAL7016	7W	3000K	90°	750	75	

Energy rating is a reflection of the LED light source.

Wiring information

Cable / flying lead	cable diameter for connection 12mm
Type of wiring required	Parallel

Accessories

N/A (No Accessories required)

Bollards

7W 7W

IP54 IP54 ideal for walk ways and step lighting

CRI>80 CRI 80 providing true colour appearance

Guarantee

3 years

Features & benefits

IK08 for robust impact protection

Great for soft illumination onto stone paths

Anthracite RAL 7016

Beam angle: 90°

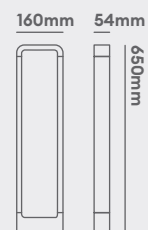
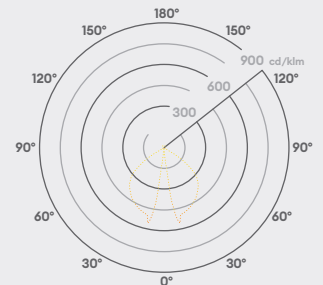

Uplights



Uplights

To create exceptionally lit environments

In architecture, the façade of a building is the first place a visitor will see, and sets the tone for the rest of the building. Captivate passers-by with a mesmerising wash of light over any beautiful structure.

Choosing the right beam angle

Our uplighting range is ideal for creating an array of effects; whether you are adding grandeur to buildings, highlighting intricate architectural features or drawing guests to an entrance, we have a solution for many applications.

60° beam

This wide beam is perfect for creating a wash of light on flat surfaces or to illuminate surfaces from further away.



30° beam

Some architectural features require mid-level lighting and the 30° beam is perfect for this, allowing a swathe of light to be cast across a dedicated area.

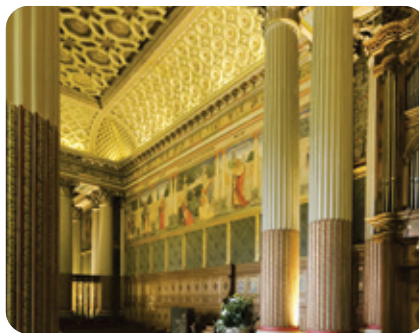

25x35° beam

Choose the asymmetric 25x35° beam for a more directed beam of light, perfect for walls and entrances.



Choosing the ideal size and output

Diagrams shown are Mains

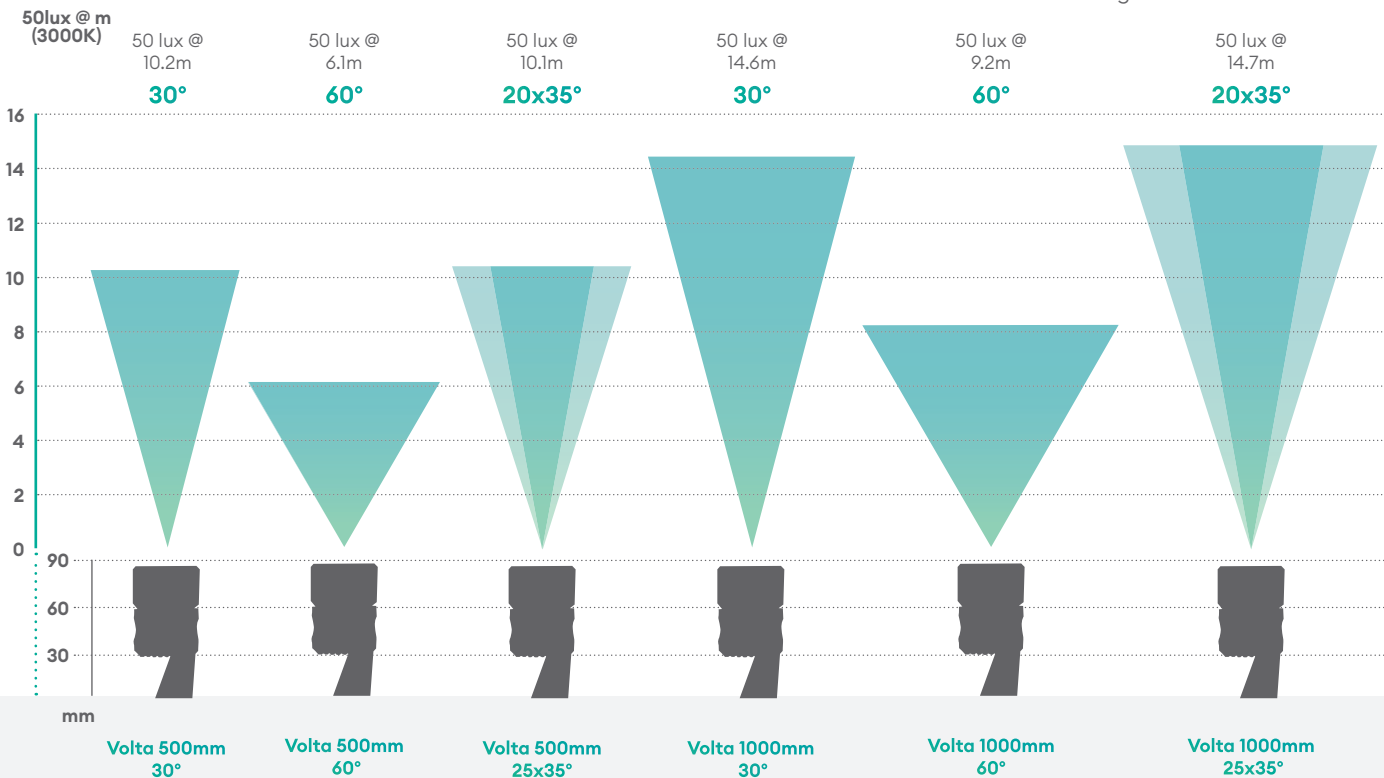

Quick and easy installation

Flexible installation

The maximum distance between products using fly leads is 330mm. if you require further space between products, Volta is supplied with two additional connectors, male and female to allow flexibility to increase distance between fittings at installation. additional cables not supplied.



Adjustable brackets

Fully flexible first-fix bracket. Slides at each end of the product and can be attached anywhere.

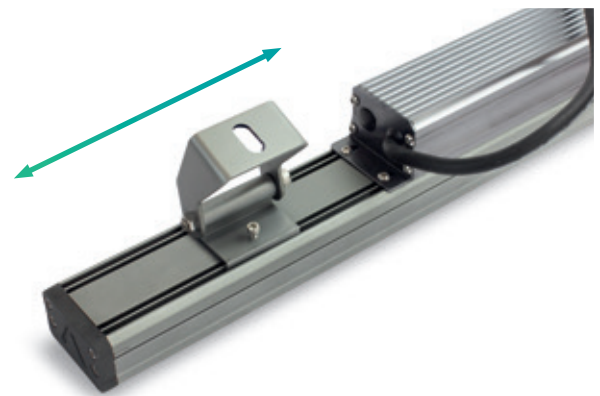

IP65

Built for the toughest of environments

High water and dust resistance. Durable and versatile, the Volta uplights are IP65 rated and are suitable for outdoors.



7 year warranty

Offering a seven-year warranty, so you can be assured of our commitment to quality.



Coastal protection

Rust & salt mist protection

With corrosion resistant protection and coastal protective paint, our floodlights are perfect for use in coastal areas.

Advantages

- Feel confident you can install these uplights anywhere.
- Can be installed into coastal areas without any worry of products failing.

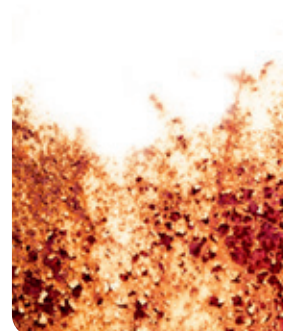

Uplights

21W 21W

IP65 IP65 ideal for outdoor environments

 Suitable for use in coastal applications

Guarantee

7 years

Features & benefits

Plug and play through-wire install method

Supplied with waterproof connectors for fast install

3000K and 2700K range with choice of 2000 or 4200 lumen output

Narrow beam 30°, Wide beam 60° or Asymmetrical 20x35°

Also available in 1000mm

Beam angle: 30°, 60°, 20x35°

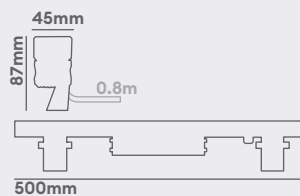
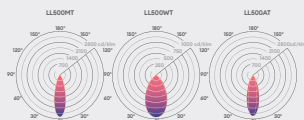

Volta 500mm

Wall washing light bar

Features

IK rating	IK04
IP rating	IP65
CSP switchable	Single CCT
Tilttable	180°
Dimmable	Yes (Mains)
Input	220-240V AC
LED lifetime	L70 50,000h
CRI	CRI>80
SDCM	SDCM3

Installation information

Inrush current	0.56A 18.8ms
Construction material	Anodised aluminium
Suitable for coastal areas	Yes
Weight	1.4kg
Maximum ambient temperature	50°C
SELV	Yes
Electric class (1, 2, 3)	1
Earth leakage	0.1mA

Photometrics @ 25°C

Product code	Finish	W	CCT	∠	lm	lm/W	Energy
LL500AT27	Silver	21W	2700K	20x35°	2000	95	
LL500AT30	Silver	21W	3000K	20x35°	2000	95	
LL500MT27	Silver	21W	2700K	30°	2000	95	
LL500MT30	Silver	21W	3000K	30°	2000	95	
LL500WT27	Silver	21W	2700K	60°	2000	95	
LL500WT30	Silver	21W	3000K	60°	2000	95	

Energy rating is a reflection of the LED light source.

Wiring information

Cable / flying lead	0.8m (H05RN-F) rubberised cable (outside diameter: 7mm)
Type of wiring required	Parallel

Accessories

N/A (No Accessories required)



Volta 1000mm

Wall washing light bar

Features

IK rating	IK04
IP rating	IP65
CSP switchable	Single CCT
Tilttable	180°
Dimmable	Yes (Mains)
Input	220-240V AC
LED lifetime	L70 50,000h
CRI	CRI>80
SDCM	SDCM3

Installation information

Inrush current	15A $\leq 10\mu s$
Construction material	Anodised aluminium
Suitable for coastal areas	Yes
Weight	2.5kg
Maximum ambient temperature	50°C
SELV	Yes
Electric class (1, 2, 3)	1
Earth leakage	0.1mA

Photometrics @ 25°C

Product code	Finish	W	CCT	\angle°	lm	lm/W	Energy
LL1000AT27	Silver	40W	2700K	20x35°	4200	105	
LL1000AT30	Silver	40W	3000K	20x35°	4200	105	
LL1000MT27	Silver	40W	2700K	30°	4200	105	
LL1000MT30	Silver	40W	3000K	30°	4200	105	
LL1000WT27	Silver	40W	2700K	60°	4200	105	
LL1000WT30	Silver	40W	3000K	60°	4200	105	

Energy rating is a reflection of the LED light source.

Wiring information

Cable / flying lead	0.8m (H05RN-F) rubberised cable (outside diameter: 7mm)
Type of wiring required	Parallel

Accessories

N/A (No Accessories required)

Uplights

40W 40W

IP65 IP65 ideal for outdoor environments

 Suitable for use in coastal applications

Guarantee

7 years

Features & benefits

Plug and play through-wire install method

Supplied with waterproof connectors for fast install

3000K and 2700K range with choice of 2000 or 4200 lumen output

Narrow beam 30°, Wide beam 60° or Asymmetrical 20x35°

Also available in 500mm

Beam angle: 30°, 60°, 20x35°

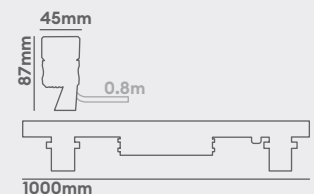
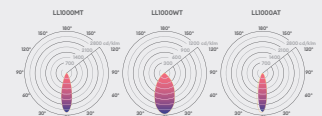

Soffit downlights



Soffit downlights

Bring your landscape lighting scheme to your door

Soffit lights allow you to tie your lighting scheme from the building to the landscaping.

IP65 front and back

The H2 Pro Extreme is IP65 from the front and the back making it perfect for soffits and other outdoor installations. Where most IP65 downlights would fail due to moisture getting in through the back of the product the H2 Pro Extreme thrives being completely protected at an IP65 rating.



Warmer light

2200K **Ember** light

Minimising the blue light content of outdoor lighting is key to improving the survival and growth rates of nocturnal animals.

That's why Collingwood is introducing outdoor lighting with 2200K. The amount of blue light in 2200K is significantly less than 4000K or even 3000K.

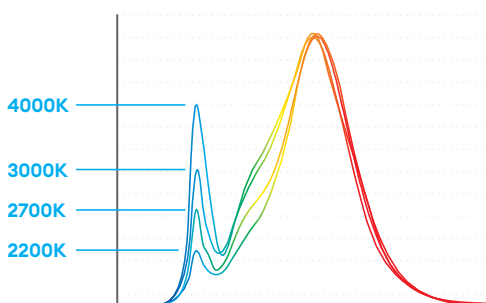

Coastal protection

Rust & salt mist protection

With corrosion resistant protection and coastal protective paint, H2 Pro Extreme CSP are perfect for use in coastal areas.

Advantages

- Feel confident you can install our products anywhere.
- Can be installed into coastal areas without any worry of products failing.

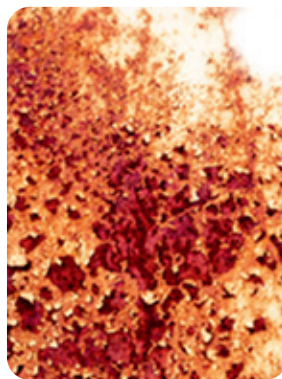

Colour Switchable Product

One light, three colour temperatures

Always have the correct product on hand. Our range of colour switchable downlights are available to stock in 3 colour temperatures in 1 product (2200K, 2700K, 3000K).

Advantages

- Simpler product range.
- Products can be adjusted after they are installed.

2200K



2700K



3000K





H2 Pro Extreme CSP

IP65 (above+below) downlight suitable for installing outdoor in building soffits and canopies

Features

IP rating	IP65 (from below and above)
CSP switchable	Switchable CCT
Tiltable	No
UGR	22
Dimmable option	Yes (Mains)
Input	220-240V AC
LED lifetime	L70 40,000h
Colour rendering index	CRI>80
Colour consistency	SDCM4
Emergency option	No

Installation information

Install connector type	Flying lead
Insulation coverable	No
Cut out size (mm)	65-75
Bathroom zone	1 (ceiling only)
Inrush current	2.3A 0.06ms
Construction material	Aluminium / Plastic
Maximum ceiling thickness	30 mm
Weight	148g
Maximum ambient temperature	-20°C - 40°C
SELV	Yes
Building regulations	Part C, P & L
Ceiling joist approvals	No
Electric class (1, 2, 3)	2

Photometrics @ 25°C

Product code	Feature	Finish	W	CCT	∠°	lm	lm/W	Energy
H2EXT1A	Switchable CCT	Anthracite grey RAL7016	5W	2200K	40°	480	96	
				2700K	40°	570	114	
				3000K	40°	560	112	
H2EXT1B	Switchable CCT	Black	5W	2200K	40°	480	96	
				2700K	40°	570	114	
				3000K	40°	560	112	
H2EXT1W	Switchable CCT	White	5W	2200K	40°	480	96	
				2700K	40°	570	114	
				3000K	40°	560	112	

Energy rating is a reflection of the LED light source.

Wiring information

Cable / flying lead	0.37m H03VVH2-F 2x0.75mm ²
Cable required for connector	N/A
Type of wiring required	Parallel

Accessories

DM298GRID	Grid Dimmer	Sold Separately
DM298FP	Flatplate Dimmer	Sold Separately
PCELLKIT	Wall Mounted Photocell Kit	Sold Separately

Soffit Downlights

IP65 IP65 from above and below for total protection

Suitable for use in coastal applications

New 2200K to minimise effects of blue light

Guarantee

4 years

Features & benefits

Use 2700K to illuminate materials such as wooden fences, sand or red brick to highlight warm tones

Select 2200K to minimise the effects blue light content has on nocturnal animals to help survival and growth rates

Collingwood Switchable Product

TRIAC mains dimmable suitable for leading and trailing edge dimmers

Integrated corrosion protected bezel

Pair with dusk to dawn sensor PCELL kit to bring on when dark and off when light

Beam angle: 40°

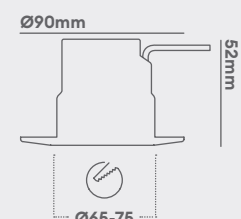
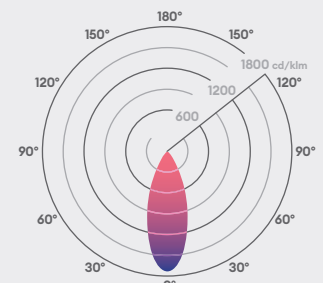

Residential Floodlights



Residential floodlights

Functional and security lighting

The Collingwood residential floodlights have been upgraded to be the most efficient in the market, have an extended warranty of up to 5 years, IP65 PIR sensor and approval for installation in coastal areas.

IP65 directional PIR sensor

PIR sensor: Passive infrared sensor

The IP65 rating provides optimum protection against the impacts of rainwater and general adverse weather conditions. The PIR sensor can rotate, meaning that the activation can occur in a different area to where the floodlight illuminates. For example, the sensor could be pointed to a door so that when a person exits the building a separate walkway is illuminated, increasing safety.

Advantages

- IP65 rated sensor ideal for adverse weather conditions.
- Sensor rotates allowing the activation to occur in a different area to the illumination.
- Easily adjust motion sensitivity, lux levels and time required on the sensor.
- Save your customer energy and money.



Coastal protection

Rust & salt mist protection

With corrosion resistant protection and coastal protective paint, our floodlights are perfect for use in coastal areas.

Advantages

- Feel confident you can install these floodlights anywhere.
- Can be installed into coastal areas without any worry of products failing.



Quick & easy installation bracket

Circular first fix bracket

The circular bracket is detachable and can be mounted to the surface before the rest of the product, allowing for a remarkably easy installation. The product is then simply bolted on to the bracket and the installation completed.

Advantages

- Quick & easy installation.
- This bracket is for first fixing onto the wall, and because it's circular, there is no need for spirit level.
- 360° rotation, allowing the floodlight to be installed in a variety of applications.
- Pre-wired with 1m cable.



360° rotatable and 180° tiltable

Flexibility and reliability

Combining 360° rotation and 180° tilt, this light can be pointed in any direction, ensuring you can illuminate a space from any position.

360° rotation

The product has a circular bracket at the end which allows it to be rotated in any direction. Once installed onto a wall, the light can be pointed in any direction with ease.

180° tiltable

The bracket directly attached to the floodlight allows the product to tilt both upwards and downwards.

Advantages

- Illuminate space from any direction.
- Can adjust into correct area after it's installed.



CCT switchable

One light, three colour temperatures

Our range of colour switchable floodlights allows you to stock 3 colour temperatures in 1 product (3000K, 4000K & 6500K).

Advantages

- Simpler product range.
- Products can be easily adjusted after they are installed thanks to a convenient IP65 switch on the back.
- Always have the correct product on hand.

3000K



4000K



6500K



Product comparison

Using the diagram below, determine which size product and output is suitable for your installation.

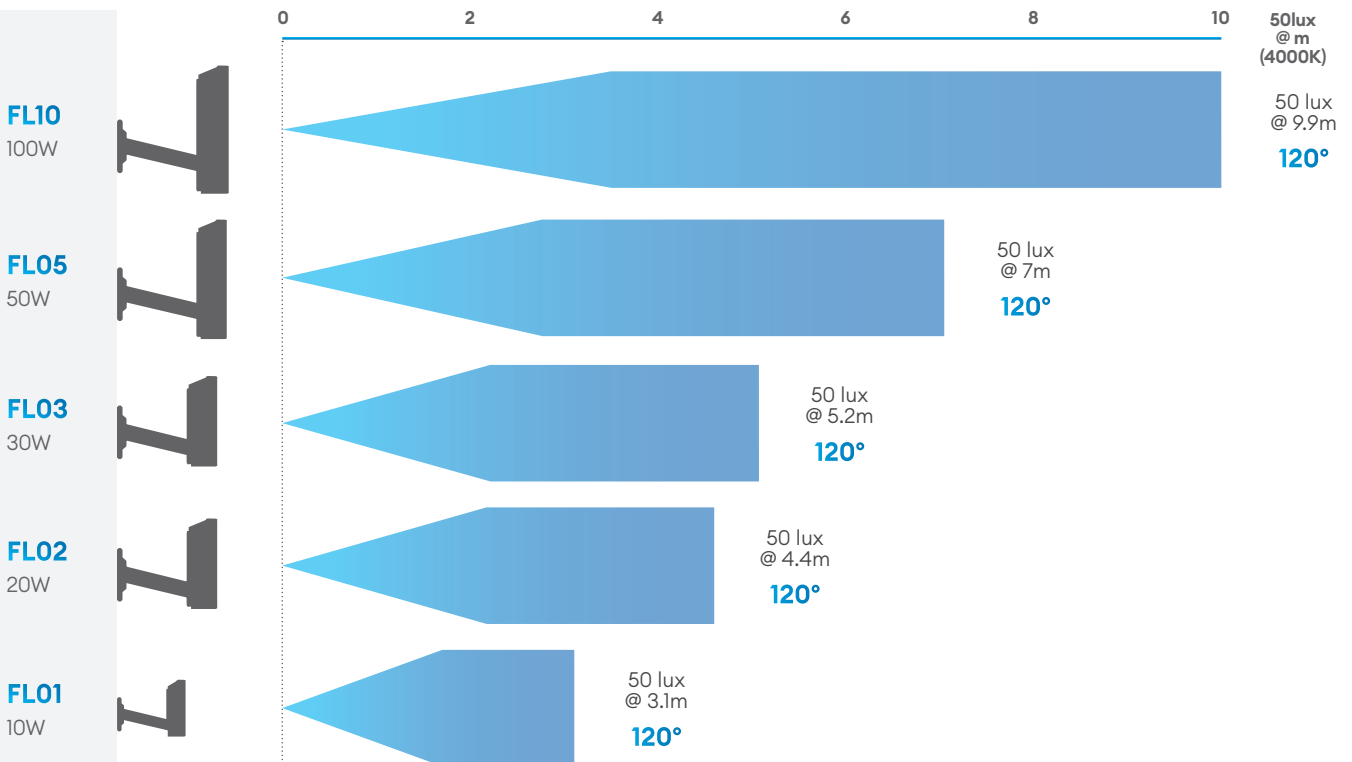

Residential Floodlights

130lm/W High efficacy of up to 130lm/W

 First fix bracket for quick & easy installation

 Ideal for coastal areas

Guarantee

5 years

Features & benefits

Colour switchable between 3 colour temperatures

IP65 rated, meaning it provides optimum protection against the impacts of rainwater and general adverse weather conditions

A unique 360° rotation for total flexibility, and a 180° tilt

Supplied with 1m cable

Wide 120° beam angle, reducing the number of fittings per area required

Performs in even more extreme conditions from -40°C to +40°C

IP65 PIR option provides override function to leave permanently on or off

Beam angle: **C0/C180 C90/C270**

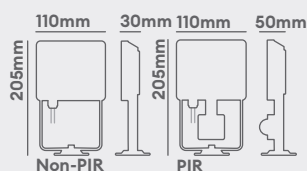
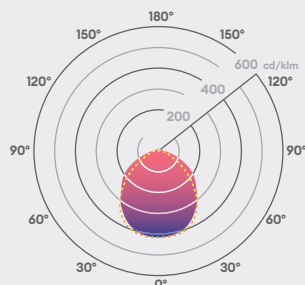

FL01

10W colour switchable floodlight







Features

IK rating	IK07
IP rating	IP65
CSP switchable	Switchable CCT
Tiltable	180°
Rotatable	360°
UGR	14
Dimmable	No
Input	220-240V AC
LED lifetime	L70 50,000h
Colour rendering Index	CRI>80
Colour consistency	SDCM5

Installation information

Inrush current	10A 262μs
Construction material	Anthracite painted cast aluminium
Suitable for coastal areas	Yes
Weight	480g
Maximum ambient temperature	-40°C - 40°C
Electric class (1, 2, 3)	1
Earth leakage	0.1mA

Photometrics @ 25°C

Product code	Feature	Finish	W	Colour	∠°	lm	lm/W	Energy
FL01APCS	PIR sensor	Anthracite grey RAL7016	10W	3000K	120°	1100	110	
				4000K	120°	1150	115	
				6500K	120°	1300	130	
FL01AXCS	Standard	Anthracite grey RAL7016	10W	3000K	120°	1100	110	
				4000K	120°	1150	115	
				6500K	120°	1300	130	
FL01BPCS	PIR sensor	Black	10W	3000K	120°	1100	110	
				4000K	120°	1150	115	
				6500K	120°	1300	130	
FL01BXCS	Standard	Black	10W	3000K	120°	1100	110	
				4000K	120°	1150	115	
				6500K	120°	1300	130	
FL01WPCS	PIR sensor	White RAL9016	10W	3000K	120°	1100	110	
				4000K	120°	1150	115	
				6500K	120°	1300	130	
FL01WXCS	Standard	White RAL9016	10W	3000K	120°	1100	110	
				4000K	120°	1150	115	
				6500K	120°	1300	130	

Energy rating is a reflection of the LED light source.

Wiring information

Cable / flying lead	1m H05RN-F rubberised cable 3x1.0mm ² Ø7mm
Type of wiring required	Parallel

Accessories

N/A (No Accessories required)



FL02

20W colour switchable floodlight

Features

IK rating	IK07
IP rating	IP65
CSP switchable	Switchable CCT
Tiltable	180°
Rotatable	360°
UGR	14
Dimmable	No
Input	220-240V AC
LED lifetime	L70 50,000h
Colour rendering Index	CRI>80
Colour consistency	SDCM5

Installation information

Inrush current	11A 474µs
Construction material	Anthracite painted cast aluminium
Suitable for coastal areas	Yes
Weight	620g
Maximum ambient temperature	-40°C - 40°C
Electric class (1, 2, 3)	1
Earth leakage	0.1mA

Photometrics @ 25°C

Product code	Feature	Finish	W	Colour	∠	Im	lm/W	Energy
FL02APCS	PIR sensor	Anthracite grey RAL7016	20W	3000K	120°	2200	110	
				4000K	120°	2400	120	
				6500K	120°	2400	120	
FL02AXCS	Standard	Anthracite grey RAL7016	20W	3000K	120°	2200	110	
				4000K	120°	2400	120	
				6500K	120°	2400	120	
FL02BPCS	PIR sensor	Black	20W	3000K	120°	2200	110	
				4000K	120°	2400	120	
				6500K	120°	2400	120	
FL02BXCS	Standard	Black	20W	3000K	120°	2200	110	
				4000K	120°	2400	120	
				6500K	120°	2400	120	
FL02WPCS	PIR sensor	White RAL9016	20W	3000K	120°	2200	110	
				4000K	120°	2400	120	
				6500K	120°	2400	120	
FL02WXCS	Standard	White RAL9016	20W	3000K	120°	2200	110	
				4000K	120°	2400	120	
				6500K	120°	2400	120	

Energy rating is a reflection of the LED light source.

Wiring information

Cable / flying lead	1m H05RN-F rubberised cable 3x1.0mm ² Ø7mm
Type of wiring required	Parallel

Accessories

N/A (No Accessories required)

Residential Floodlights

- High efficacy of up to 120lm/W
- First fix bracket for quick & easy installation
- Ideal for coastal areas

Guarantee

5 years

Features & benefits

Colour switchable between 3 colour temperatures

IP65 rated, meaning it provides optimum protection against the impacts of rainwater and general adverse weather conditions

A unique 360° rotation for total flexibility, and a 180° tilt

Supplied with 1m cable

Wide 120° beam angle, reducing the number of fittings per area required

Performs in even more extreme conditions from -40°C to +40°C

IP65 PIR option provides override function to leave permanently on or off

Beam angle: C0/C180 C90/C270

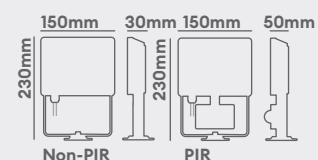
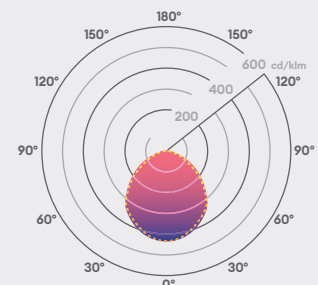

Residential Floodlights

130lm/W High efficacy of up to 130lm/W

 First fix bracket for quick & easy installation

 Ideal for coastal areas

Guarantee

5 years

Features & benefits

Colour switchable between 3 colour temperatures

IP65 rated, meaning it provides optimum protection against the impacts of rainwater and general adverse weather conditions

A unique 360° rotation for total flexibility, and a 180° tilt

Supplied with 1m cable

Wide 120° beam angle, reducing the number of fittings per area required

Performs in even more extreme conditions from -40°C to +40°C

IP65 PIR option provides override function to leave permanently on or off

Beam angle: **C0/C180 C90/C270**

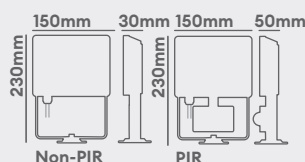
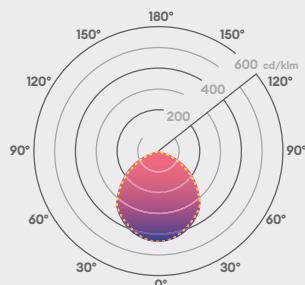

FL03

30W colour switchable floodlight

Features

IK rating	IK07
IP rating	IP65
CSP switchable	Switchable CCT
Tiltable	180°
Rotatable	360°
UGR	14
Dimmable	No
Input	220-240V AC
LED lifetime	L70 50,000h
Colour rendering Index	CRI>80
Colour consistency	SDCM5

Installation information

Inrush current	30A 4μs
Construction material	Anthracite painted aluminium
Suitable for coastal areas	Yes
Weight	630g
Maximum ambient temperature	-40°C - 40°C
Electric class (1, 2, 3)	1
Earth leakage	0.1mA

Photometrics @ 25°C

Product code	Feature	Finish	W	Colour	∠°	Im	lm/W	Energy
FL03APCS	PIR sensor	Anthracite grey RAL7016	30W	3000K	120°	3000	100	
				4000K	120°	3300	110	
				6500K	120°	3900	130	
FL03AXCS	Standard	Anthracite grey RAL7016	30W	3000K	120°	3000	100	
				4000K	120°	3300	110	
				6500K	120°	3900	130	
FL03BPXS	PIR sensor	Black	30W	3000K	120°	3000	100	
				4000K	120°	3300	110	
				6500K	120°	3900	130	
FL03BXCS	Standard	Black	30W	3000K	120°	3000	100	
				4000K	120°	3300	110	
				6500K	120°	3900	130	
FL03WPXS	PIR sensor	White RAL9016	30W	3000K	120°	3000	100	
				4000K	120°	3300	110	
				6500K	120°	3900	130	
FL03WXCS	Standard	White RAL9016	30W	3000K	120°	3000	100	
				4000K	120°	3300	110	
				6500K	120°	3900	130	

Energy rating is a reflection of the LED light source.

Wiring information

Cable / flying lead	1m H05RN-F rubberised cable 3x1.0mm ² Ø7mm
Type of wiring required	Parallel

Accessories

N/A (No Accessories required)

Residential Floodlights



FL05

50W colour switchable floodlight

Features

IK rating	IK07
IP rating	IP65
CSP switchable	Switchable CCT
Tiltable	180°
Rotatable	360°
UGR	14
Dimmable	No
Input	220-240V AC
LED lifetime	L70 50,000h
Colour rendering Index	CRI>80
Colour consistency	SDCM4

Installation information

Inrush current	28A 13μs
Construction material	Anthracite painted cast aluminium
Suitable for coastal areas	Yes
Weight	1250g
Maximum ambient temperature	-40°C - 40°C
Electric class (1, 2, 3)	1
Earth leakage	0.1mA

Photometrics @ 25°C

Product code	Feature	Finish	W	Colour	∠	Im	lm/W	Energy
FL05APCS	PIR sensor	Anthracite grey RAL7016	50W	3000K	120°	5000	100	
				4000K	120°	5600	112	
				6500K	120°	5100	102	
FL05AXCS	Standard	Anthracite grey RAL7016	50W	3000K	120°	5000	100	
				4000K	120°	5600	112	
				6500K	120°	5100	102	
FL05BPCS	PIR sensor	Black	50W	3000K	120°	5000	100	
				4000K	120°	5600	112	
				6500K	120°	5100	102	
FL05BXCS	Standard	Black	50W	3000K	120°	5000	100	
				4000K	120°	5600	112	
				6500K	120°	5100	102	
FL05WPCS	PIR sensor	White RAL9016	50W	3000K	120°	5000	100	
				4000K	120°	5600	112	
				6500K	120°	5100	102	
FL05WXCS	Standard	White RAL9016	50W	3000K	120°	5000	100	
				4000K	120°	5600	112	
				6500K	120°	5100	102	

Energy rating is a reflection of the LED light source.

Wiring information

Cable / flying lead	1m H05RN-F rubberised cable 3x1.0mm ² Ø7mm
Type of wiring required	Parallel

Accessories

N/A (No Accessories required)

112lm/W High efficacy of up to 112lm/W

First fix bracket for quick & easy installation

Ideal for coastal areas

Guarantee

5 years

Features & benefits

Colour switchable between 3 colour temperatures

IP65 rated, meaning it provides optimum protection against the impacts of rainwater and general adverse weather conditions

A unique 360° rotation for total flexibility, and a 180° tilt

Supplied with 1m cable

Wide 120° beam angle, reducing the number of fittings per area required

Performs in even more extreme conditions from -40°C to +40°C

IP65 PIR option provides override function to leave permanently on or off

Beam angle: C0/C180 C90/C270

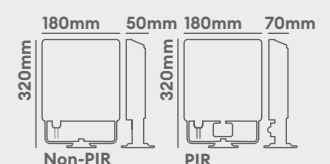
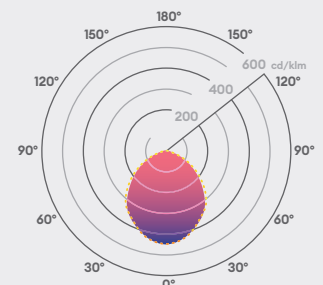

Residential Floodlights

118lm/W High efficacy of up to 118lm/W

 First fix bracket for quick & easy installation

 Ideal for coastal areas

Guarantee

5 years

Features & benefits

Colour switchable between 3 colour temperatures

IP65 rated, meaning it provides optimum protection against the impacts of rainwater and general adverse weather conditions

A unique 360° rotation for total flexibility, and a 180° tilt

Supplied with 1m cable

Wide 120° beam angle, reducing the number of fittings per area required

Performs in even more extreme conditions from -40°C to +40°C

Beam angle: **C0/C180** **C90/C270**

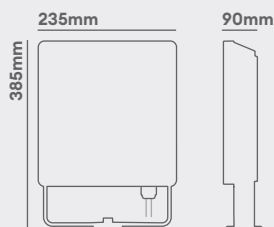
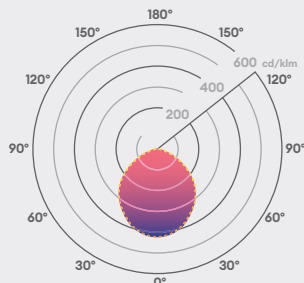

FL10

100W colour switchable floodlight

Features

IK rating	IK07
IP rating	IP65
CSP switchable	Switchable CCT
Tilttable	180°
Rotatable	360°
UGR	14
Dimmable	No
Input	220-240V AC
LED lifetime	L70 50,000h
Colour rendering Index	CRI>80
Colour consistency	SDCM4

Installation information

Inrush current	75A 5μs
Construction material	Black painted cast aluminium
Suitable for coastal areas	Yes
Weight	2100g
Maximum ambient temperature	-40°C - 40°C
Electric class (1, 2, 3)	1
Earth leakage	0.3mA

Photometrics @ 25°C

Product code	Feature	Finish	W	Colour	△°	lm	lm/W	Energy
FL10BXCS	Standard	Black	100W	3000K	120°	10250	103	
				4000K	120°	11810	118	
				6500K	120°	10970	110	

Energy rating is a reflection of the LED light source.

Wiring information

Cable / flying lead	1m H05RN-F rubberised cable 3x1.0mm ² Ø7mm
Type of wiring required	Parallel

Accessories

N/A (No Accessories required)



Strip Lights



Choosing LED strip

Find the ideal LED strip for your installation

Use the tables below to find the ideal LED strip for your installation.

Neon (side bending)

Ideal for flat surfaces with a curved line of light.

Bend direction	IP rating	Wattage	Colour temperature	Length	Product code
Side	IP67	6.5W/m	2700K	3m	LSNS7327030
				5m	LSNS7327050
				10m	LSNS7327100
			3000K	3m	LSNS7330030
				5m	LSNS7330050
				10m	LSNS7330100
			4000K	3m	LSNS7340030
				5m	LSNS7340050
				10m	LSNS7340100
		9.6W/m	2700K	3m	LSNS7327030
				5m	LSNS7327050
				10m	LSNS7327100
			3000K	3m	LSNS7330030
				5m	LSNS7330050
				10m	LSNS7330100
			4000K	3m	LSNS7340030
				5m	LSNS7340050
				10m	LSNS7340100

Neon (top bending)

Ideal for flat surfaces with a curved line of light.

Bend direction	IP rating	Wattage	Colour temperature	Length	Product code
Top	IP67	6.5W/m	2700K	3m	LSNT7327030
				5m	LSNT7327050
				10m	LSNT7327100
			3000K	3m	LSNT7330030
				5m	LSNT7330050
				10m	LSNT7330100
			4000K	3m	LSNT7340030
				5m	LSNT7340050
				10m	LSNT7340100
		9.6W/m	2700K	3m	LSNT7327030
				5m	LSNT7327050
				10m	LSNT7327100
			3000K	3m	LSNT7330030
				5m	LSNT7330050
				10m	LSNT7330100
			4000K	3m	LSNT7340030
				5m	LSNT7340050
				10m	LSNT7340100

Flexible tape

(Current regulated - Up to 20m lengths)

Current regulated technology to ensure there is no loss in light output, regardless of how long the strip is or how far away the driver is.

IP rating	Wattage	Colour temperature	Length	Product code
IP68	4.8W/m	2700K	20m	LSC8227200
			Bespoke	LSC8227... ▶
		3000K	20m	LSC8230200
			Bespoke	LSC8230... ▶
		4000K	20m	LSC8240200
			Bespoke	LSC8240... ▶
	9.6W/m	2700K	20m	LSC8527200
			Bespoke	LSC8527... ▶
		3000K	20m	LSC8530200
			Bespoke	LSC8530... ▶
		4000K	20m	LSC8540200
			Bespoke	LSC8540... ▶
	14.4W/m	2700K	10m	LSC8427100
			Bespoke	LSC8427... ▶
		3000K	10m	LSC8430100
			Bespoke	LSC8430... ▶
		4000K	10m	LSC8440100
			Bespoke	LSC8440... ▶
	17W/m	2700K	10m	LSC8627100
			Bespoke	LSC8627... ▶
3000K		10m	LSC8630100	
		Bespoke	LSC8630... ▶	
4000K		10m	LSC8640100	
		Bespoke	LSC8640... ▶	

To finish your bespoke code, see bespoke lengths table.

Bespoke lengths

Add the below 3 digits to the end of your bespoke product code to get the exact length you need

Constant voltage:

Constant voltage strip is available in bespoke lengths up to 5m.

Current regulated:

Current regulated strip is available in bespoke lengths up to 20m.

Product code	Length (m)	Product code	Length (m)	Product code	Length (m)	Product code	Length (m)
001	0.1	051	5.1	101	10.1	151	15.1
002	0.2	052	5.2	102	10.2	152	15.2
003	0.3	053	5.3	103	10.3	153	15.3
004	0.4	054	5.4	104	10.4	154	15.4
005	0.5	055	5.5	105	10.5	155	15.5
006	0.6	056	5.6	106	10.6	156	15.6
007	0.7	057	5.7	107	10.7	157	15.7
008	0.8	058	5.8	108	10.8	158	15.8
009	0.9	059	5.9	109	10.9	159	15.9
010	1	060	6	110	11	160	16
011	1.1	061	6.1	111	11.1	161	16.1
012	1.2	062	6.2	112	11.2	162	16.2
013	1.3	063	6.3	113	11.3	163	16.3
014	1.4	064	6.4	114	11.4	164	16.4
015	1.5	065	6.5	115	11.5	165	16.5
016	1.6	066	6.6	116	11.6	166	16.6
017	1.7	067	6.7	117	11.7	167	16.7
018	1.8	068	6.8	118	11.8	168	16.8
019	1.9	069	6.9	119	11.9	169	16.9
020	2.0	070	7	120	12.0	170	17
021	2.1	071	7.1	121	12.1	171	17.1
022	2.2	072	7.2	122	12.2	172	17.2
023	2.3	073	7.3	123	12.3	173	17.3
024	2.4	074	7.4	124	12.4	174	17.4
025	2.5	075	7.5	125	12.5	175	17.5
026	2.6	076	7.6	126	12.6	176	17.6
027	2.7	077	7.7	127	12.7	177	17.7
028	2.8	078	7.8	128	12.8	178	17.8
029	2.9	079	7.9	129	12.9	179	17.9
030	3	080	8	130	13	180	18
031	3.1	081	8.1	131	13.1	181	18.1
032	3.2	082	8.2	132	13.2	182	18.2
033	3.3	083	8.3	133	13.3	183	18.3
034	3.4	084	8.4	134	13.4	184	18.4
035	3.5	085	8.5	135	13.5	185	18.5
036	3.6	086	8.6	136	13.6	186	18.6
037	3.7	087	8.7	137	13.7	187	18.7
038	3.8	088	8.8	138	13.8	188	18.8
039	3.9	089	8.9	139	13.9	189	18.9
040	4	090	9	140	14	190	19
041	4.1	091	9.1	141	14.1	191	19.1
042	4.2	092	9.2	142	14.2	192	19.2
043	4.3	093	9.3	143	14.3	193	19.3
044	4.4	094	9.4	144	14.4	194	19.4
045	4.5	095	9.5	145	14.5	195	19.5
046	4.6	096	9.6	146	14.6	196	19.6
047	4.7	097	9.7	147	14.7	197	19.7
048	4.8	098	9.8	148	14.8	198	19.8
049	4.9	099	9.9	149	14.9	199	19.9
050	5	100	10	150	15	200	20.0

Profile for neon side bending strip

Find the perfect profile for your neon strip

Use a profile to mount your neon strip to a surface.

Fixed straight

Ideal for surface mounting and creating straight lines



LSNS1217PPC

Side bending Neon strip polycarbonate profile

Product code	1m: LSNS1217PPC
Construction material	Polycarbonate
Dimensions	15 x 19 x 1000mm
Guarantee	3 year



LSNS1217PAL

Side bend Neon strip aluminum profile, with cove for cable underneath the strip

Product code	1m: LSNS1217PAL
Construction material	Aluminium
Dimensions	15 x 25 x 1000mm
Guarantee	3 year

Side bending

Ideal for surface mounting and creating curved shapes

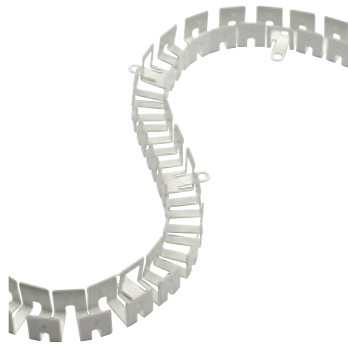

LSNS1217PFL

Side bending Neon strip flexible profile

Product code	0.5m: LSNS1217PFL
Construction material	Aluminium
Dimensions	28 x 12 x 500mm
Guarantee	3 year

Clips

All purpose surface mounting clips



LSNS1217MPC

Side bending Neon strip polycarbonate clip
Install every 33cm

Product code	1m: LSNS1217PPC
Construction material	Polycarbonate
Dimensions	15 x 19 x 1000mm
Guarantee	3 year



LSNS1217MAL

Side bending Neon strip aluminum clip, with cove for cable underneath strip
Install every 33cm

Product code	1m: LSNS1217PPC
Construction material	Polycarbonate
Dimensions	15 x 19 x 1000mm
Guarantee	3 year

Profile for neon top bending strip

Find the perfect profile for your neon strip

Use a profile to mount your neon strip to a surface.

Fixed straight

Ideal for surface mounting and creating straight lines



LSNT1312PPC

Top bending Neon strip polycarbonate profile

Product code	1m: LSNT1312PPC
Construction material	Polycarbonate
Dimensions	15 x 15 x 1000mm
Guarantee	3 years



LSNT1312PAL

Top bend Neon strip aluminum profile, with cove for cable underneath the strip

Product code	1m: LSNT1312PAL
Construction material	Aluminium
Dimensions	15 x 19 x 1000mm
Guarantee	3 year

Top bending

Ideal for surface mounting and creating curved shapes

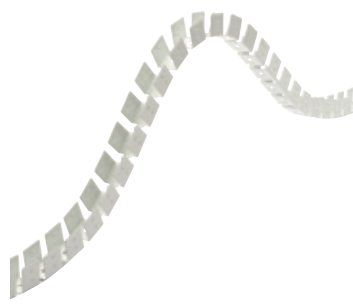

LSNT1312PFL

Top bending Neon strip flexible profile

Product code	50cm: LSNT1312PFL
Construction material	Aluminium
Dimensions	14 x 14 x 500mm
Guarantee	3 year

Clips

All purpose surface mounting clips



LSNT1312MPC

Top bending Neon strip polycarbonate clip
Install every 33cm

Product code	1m: LSNT1312MPC
Construction material	Polycarbonate
Dimensions	15 x 15 x 25mm
Guarantee	3 year

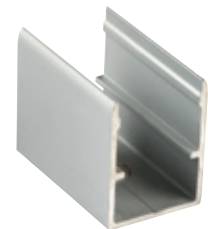

LSNT1312MAL

Top bending Neon strip aluminum clip, with cove for cable underneath strip
Install every 33cm

Product code	1m: LSNT1312MAL
Construction material	Aluminium
Dimensions	15 x 19 x 25mm
Guarantee	3 year

Choosing Neon strip connectors

Find the ideal connectors for your strip

Use the matrix to find the perfect connectors for your Neon strip

Strip to strip

Strip to strip connectors connect one end of the strip directly to another end of strip creating an almost seamless transition from one piece of strip to the next.



Strip to strip with fly-leads

Connect one piece of strip to another with the flexibility of having fly-leads between them.



Fly-leads

Use a connector that adds fly-leads to your strip to connect your strip to a power supply.



End cap

This is needed at the end of neon strip to complete the circuit.



LSNS1217B2P

LSNS1217E2P

LSNS1217L2P

LSNS1217R2P

LSNS1217SSF

LSNS1217SS

LSNS1217EC

LSNT1312B2P

LSNT1312E2P

LSNT1312L2P

LSNT1312R2P

LSNT1312SSF

LSNT1312SS

LSNT1312EC

Connector information														
Type	150mm fly-lead at bottom	150mm fly-lead at end	150mm fly-lead at left	150mm fly-lead at right	Strip to strip 150mm fly-lead	Strip to strip	End cap	150mm fly-lead at bottom	150mm fly-lead at end	150mm fly-lead at left	150mm fly-lead at right	Strip to strip 150mm fly-lead	Strip to strip	End cap
Neon strip														
LSNS73	●	●	●	●	●	●	●							
LSNS75	●	●	●	●	●	●	●							
LSNT73								●	●	●	●	●	●	●
LSNT75								●	●	●	●	●	●	●

Choosing LED strip profile

Find the ideal profile for your installation

Use the matrix to find the perfect profile for your LED strip

	RP7	RP28	SM7	SM28	C07	LSNS1217MPC	LSNS1217MAL	LSNS1217PPC	LSNS1217PAL	LSNS1217PFL	LSNT1312MPC	LSNT1312MAL	LSNT1312PPC	LSNT1312PAL	LSNT1312PFL
Profile information															
Mount	Recessed	Recessed	Surface mount	Surface mount	Corner	Surface mount	Surface mount	Surface mount	Surface mount	Surface mount	Surface mount	Surface mount	Surface mount	Surface mount	Surface mount
Type	Straight	Straight	Straight	Straight	Straight	Clip	Clip	Straight	Straight	Side bending	Clip	Clip	Straight	Straight	Top bending
Depth	7mm	28mm	7mm	28mm	7mm	19mm	28mm	19mm	28mm	12mm	15mm	19mm	15mm	19mm	14mm
Length	2m	2m	1m / 2m	1m / 2m	1m / 2m	-	-	1m	1m	-	-	-	1m	1m	-
Flexible tape - Current regulated															
LSC82		•		•											
LSC84		•		•											
LSC85		•		•											
LSC86		•		•											
Neon strip															
LSNS73						•	•	•	•	•					
LSNS75						•	•	•	•	•					
LSNT73											•	•	•	•	•
LSNT75											•	•	•	•	•

Choosing drivers for LED strip

Find the ideal driver for your strip

Use the matrix to find the perfect driver for your LED strip

	PS1524	PS3024B	PSMD3024	LSD6024
Driver information				
Constant current or Constant voltage	CV	CV	CV	CV
Output classification	24V	24V	24V	24V
IP rating	IP20	IP20	IP20	IP20
Dimmable	1-10V*	1-10V*	Mains	1-10V*
DIN rail mount	No	No	No	No
Plug & Play	No	No	No	No

*Requires a PDCINT1-10V interface to make it 1 - 10V dimmable

Flexible tape - Current regulated				
LSC82	3.1m	6.2m	3.8-6.2m	12.5m
LSC84	1m	2m	1.3-2m	4.1m
LSC85	1.5m	3.1m	1.9-3.1m	6.2m
LSC86	0.8m	1.7m	1.1-1.7m	3.5m

Neon strip				
LSNS73	2.3m	4.6m	2.8-4.6m	9.2m
LSNS75	1.5m	3.1m	1.9-3.1m	6.2m
LSNT73	2.3m	4.6m	2.8-4.6m	9.2m
LSNT75	1.5m	3.1m	1.9-3.1m	6.2m

PSDIP6024	PS7524	PSDIP10024	PSMDIP10024	LSD12024	PSIP15024	PSDAL20024	PSIP25024
CV	CV	CV	CV	CV	CV	CV	CV
24V	24V	24V	24V	24V	24V	24V	24V
IP66	IP20	IP66	IP66	IP20	IP67	IP66	IP67
1-10V	No	1-10V*	Mains	1-10V*	1-10V*	DALI	1-10V*
No	No	No	No	No	No	No	No
No	No	No	No	No	No	No	No

12.5m	15.6m	20.8m	20.8m	25m	31.2m	41.6m	52m
4.1m	5.2m	6.9m	6.9m	8.3m	10.4m	13.8m	17.3m
6.2m	7.8m	10.4m	10.4m	12.5m	15.6m	20.8m	26m
3.5m	4.4m	5.8m	5.8m	7m	8.8m	11.7m	14.7m

9.2m	11.5m	15.3m	15.3m	18.4m	23m	30.7m	38.4m
6.2m	7.8m	10.4m	10.4m	12.5m	15.6m	20.8m	26m
9.2m	11.5m	15.3m	15.3m	18.4m	23m	30.7m	38.4m
6.2m	7.8m	10.4m	10.4m	12.5m	15.6m	20.8m	26m

Strip Lights

4.8W/m

Ideal for accent lighting with 4.8W/m

IP68

Ideal for wet environments with IP68



Bespoke lengths available

Guarantee

5 years Cutting to required length will render this product non-returnable

Features & benefits

1, 2, 3, 4 or 5m flying leads available at bespoke request

Has high quality LED strip using current regulation without experiencing any light drop off

Long lengths (up to 20m) suffer no light loss

Cut points are every 100mm

Quick and easy installation with 3M self-adhesive backing

High efficacy of 88lm/W

High-grade silicone extruded coating, UV resistant

CRI 90 providing true colour appearance

Beam angle: 120°

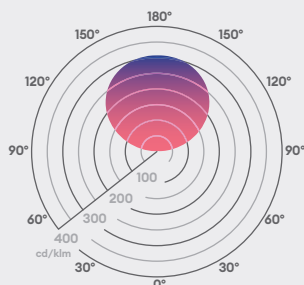

20m/100mm

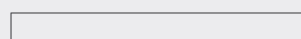

12x5mm



LSC82

4.8 W/m, IP68, 24V current regulated, high CRI, self-adhesive, waterproof flexible strip

Features

Strip type	Flexible tape
IP rating	IP68
CSP switchable	Single CCT
Bespoke lengths	Yes
Self-adhesive backing	Yes
Dimmable option	Driver dependent
LED/m	60
Input	24V DC
LED lifetime	L70 60,000h
Colour rendering Index	CRI>90
Colour consistency	SDCM3

Installation information

Bathroom zone	0
Construction material	Flexible tape with Silicone coating
Maximum running length	20 m
Weight	110g per meter
Maximum ambient temperature	-20°C - 45°C
Electric class (1, 2, 3)	3

Photometrics @ 25°C

Product code	Reel length	W	CCT	△	lm	lm/W	Energy
LSC8227200	20 m	4.8W/m	2700K	120°	360	75	
LSC8230200	20 m	4.8W/m	3000K	120°	380	79	
LSC8240200	20 m	4.8W/m	4000K	120°	420	88	

Energy rating is a reflection of the LED light source.

Wiring information

Cable / flying lead	Supplied with 500mm, 0.5mm ² flying lead from one end
Type of wiring required	Parallel

Recommended LED drivers

Product code	Input	SELV	Dimming	Bathroom zone	Products per driver
PSMDIP10024	220-240V	Yes	Yes (with PDCINT1-10V)	N/A	6m Max
PS7524	220-240V	Yes	Yes (with PDCINT1-10V)	0 (1 when dimming)	15m Max
PSIP15024	220-240V	Yes	Yes (with PDCINT1-10V)	0 (1 when dimming)	31m Max

Accessories

LED STRIP PROFILE RANGE	Profile range to house adhesive strip	Sold Separately	165
PDCINT1-10V	1-10V, Push, DALI dimming interface for use with 24V LED drivers	Sold Separately	204



LSC85

9.6 W/m, IP68, 24V current regulated, high CRI, self-adhesive, waterproof flexible strip

Features

Strip type	Flexible tape
IP rating	IP68
CSP switchable	Single CCT
Bespoke lengths	Yes
Self-adhesive backing	Yes
Dimmable option	Driver dependent
LED/m	120
Input	24V DC
LED lifetime	L70 60,000h
Colour rendering Index	CRI>90
Colour consistency	SDCM3

Installation information

Bathroom zone	0
Construction material	Flexible tape with Silicone coating
Maximum running length	20 m
Weight	147g per meter
Maximum ambient temperature	-20°C - 45°C
Electric class (1, 2, 3)	3

Photometrics @ 25°C

Product code	Reel length	W	CCT	∠	lm	lm/W	Energy
LSC8527400	40 m	9.6W/m	2700K	120°	760	79	
LSC8530400	40 m	9.6W/m	3000K	120°	800	83	
LSC8540400	40 m	9.6W/m	4000K	120°	850	89	

Energy rating is a reflection of the LED light source.

Wiring information

Cable / flying lead	Supplied with 500mm, 0.5mm ² flying lead from one end
Type of wiring required	Parallel

Recommended LED drivers

Product code	Input	SELV	Dimming	Bathroom zone	Products per driver
LSD6024	220-240V	Yes	Yes (with PDCINT1-10V)	0 (1 when dimming)	6m Max
LSD12024	220-240V	Yes	Yes (with PDCINT1-10V)	0 (1 when dimming)	12m Max
PSIP25024	220-240V	Yes	Yes (with PDCINT1-10V)	0 (1 when dimming)	26m Max

Accessories

LED STRIP PROFILE RANGE	Profile range to house adhesive strip	Sold Separately	165
PDCINT1-10V	1-10V, Push, DALI dimming interface for use with 24V LED drivers	Sold Separately	204

Strip Lights

9.6W/m Ideal for atmospheric light with 9.6W/m

IP68 Ideal for wet environments with IP68

Bespoke lengths available

Guarantee

5 years Cutting to required length will render this product non-returnable

Features & benefits

500mm flying leads soldered

Has high quality LED strip using current regulation without experiencing any light drop off

Long lengths (up to 20m) suffer no light loss

Cut points are every 50mm

Quick and easy installation with 3M self-adhesive backing

High efficacy of 89lm/W

High-grade silicone extruded coating, UV resistant

CRI 90 providing true colour appearance

Beam angle: 120°

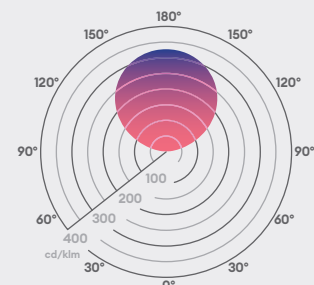

20m/50mm

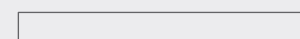

14x5mm

Strip Lights

14.4W/m

Ideal for primary light with 14.4W/m

IP68

Ideal for wet environments with IP68



Bespoke lengths available

Guarantee

5 years Cutting to required length will render this product non-returnable

Features & benefits

500mm flying leads soldered

Has high quality LED strip using current regulation without experiencing any light drop off

Long lengths (up to 10m) suffer no light loss

Cut points are every 50mm

Quick and easy installation with 3M self-adhesive backing

High efficacy of 87lm/W

High-grade silicone extruded coating, UV resistant

CRI 90 providing true colour appearance

Beam angle: 120°

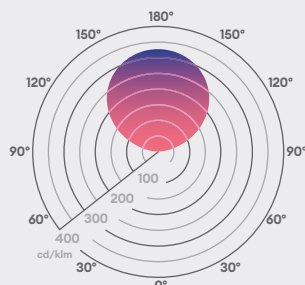

10m/50mm

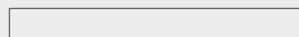

14x5mm



LSC84

14.4 W/m, IP68, 24V current regulated, high CRI, self-adhesive, waterproof flexible strip

Features

Strip type	Flexible tape
IP rating	IP68
CSP switchable	Single CCT
Bespoke lengths	Yes
Self-adhesive backing	Yes
Dimmable option	Driver dependent
LED/m	120
Input	24V DC
LED lifetime	L70 60,000h
Colour rendering Index	CRI>90
Colour consistency	SDCM3

Installation information

Bathroom zone	0
Construction material	Flexible tape with Silicone coating
Maximum running length	10 m
Weight	147g per meter
Maximum ambient temperature	-20°C - 40°C
Electric class (1, 2, 3)	3

Photometrics @ 25°C

Product code	Reel length	W	CCT	∠	lm	lm/W	Energy
LSC8427400	40 m	14.4W/m	2700K	120°	1050	73	
LSC8430400	40 m	14.4W/m	3000K	120°	1150	80	
LSC8440400	40 m	14.4W/m	4000K	120°	1250	87	

Energy rating is a reflection of the LED light source.

Wiring information

Cable / flying lead	Supplied with 500mm, 0.5mm ² flying lead from one end
Type of wiring required	Parallel

Recommended LED drivers

Product code	Input	SELV	Dimming	Bathroom zone	Products per driver
LSD6024	220-240V	Yes	Yes (with PDCINT 1-10V)	0 (1 when dimming)	4m Max
LSD12024	220-240V	Yes	Yes (with PDCINT 1-10V)	0 (1 when dimming)	8m Max
PSIP25024	220-240V	Yes	Yes (with PDCINT 1-10V)	0 (1 when dimming)	17m Max

Accessories

LED STRIP PROFILE RANGE	Profile range to house adhesive strip	Sold Separately	165
PDCINT1-10V	1-10V, Push, DALI dimming interface for use with 24V LED drivers	Sold Separately	204



LSC86

17.0 W/m, IP68, 24V current regulated, high CRI, self-adhesive, waterproof flexible strip

Features

Strip type	Flexible tape
IP rating	IP68
CSP switchable	Single CCT
Bespoke lengths	Yes
Self-adhesive backing	Yes
Dimmable option	Driver dependent
LED/m	144
Input	24V DC
LED lifetime	L70 60,000h
Colour rendering Index	CRI>90
Colour consistency	SDCM3

Installation information

Bathroom zone	0
Construction material	Flexible tape with Silicone coating
Maximum running length	10 m
Weight	126g per meter
Maximum ambient temperature	-20°C - 40°C
Electric class (1, 2, 3)	3

Photometrics @ 25°C

Product code	Reel length	W	CCT	∠	lm	lm/W	Energy
LSC8627400	40 m	17.0W/m	2700K	120°	1250	74	
LSC8630400	40 m	17.0W/m	3000K	120°	1350	79	
LSC8640400	40 m	17.0W/m	4000K	120°	1400	82	

Energy rating is a reflection of the LED light source.

Wiring information

Cable / flying lead	Supplied with 500mm, 0.5mm ² flying lead from one end
Type of wiring required	Parallel

Recommended LED drivers

Product code	Input	SELV	Dimming	Bathroom zone	Products per driver
PS7524	220-240V	Yes	Yes (with PDCINT 1-10V)	0 (1 when dimming)	3m Max
PSIP15024	220-240V	Yes	Yes (with PDCINT 1-10V)	0 (1 when dimming)	8m Max
PSIP25024	220-240V	Yes	Yes (with PDCINT 1-10V)	0 (1 when dimming)	14m Max

Accessories

LED STRIP PROFILE RANGE	Profile range to house adhesive strip	Sold Separately	165
PDCINT1-10V	1-10V, Push, DALI dimming interface for use with 24V LED drivers	Sold Separately	204

Strip Lights

- 17W/m** Ideal for primary light with 17W/m
- IP68** Ideal for wet environments with IP68
- Bespoke lengths available

Guarantee

5 years Cutting to required length will render this product non-returnable

Features & benefits

- 500mm flying leads soldered
- Has high quality LED strip using current regulation without experiencing any light drop off
- Long lengths (up to 10m) suffer no light loss
- Cut points are every 41.6mm
- Quick and easy installation with 3M self-adhesive backing
- High efficacy of 82lm/W
- High-grade silicone extruded coating, UV resistant
- CRI 90 providing true colour appearance

Beam angle: 120°

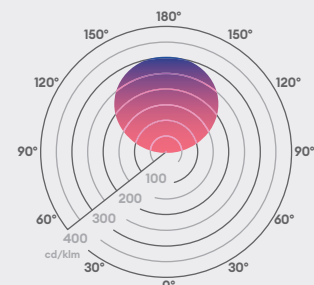

10m/41.6mm

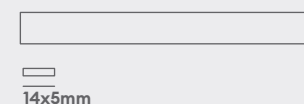

Strip Lights

6.5W/m

Ideal for accent light (6.5W/m)

IP67

Ideal for wet environments with IP67 rating



Side bending strip

Guarantee

5 years

Features & benefits

500mm flying leads soldered

High quality LED strip maintaining light quality and consistency

Long lengths (LSNS73 up to 10m / LSNS75 up to 5m) suffer no light loss

Cut points are every 50mm

A range of fixing accessories, both rigid and flexible, allowing various installations. Fixing accessories need to be acquired to allow install the neon strip

Has a high-grade silicone extruded coating, UV and Chemicals resistant

CRI 80 providing true colour appearance

Beam angle: 120°

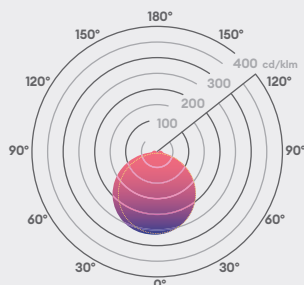

3m,5m,10m/50mm



LSNS73

6.5 W/m, IP67, 24V constant voltage, side bend, waterproof flexible neon strip

Features

Strip type	Flexible tape
IP rating	IP67
CSP switchable	Single CCT
Bespoke lengths	No
Self-adhesive backing	No
Dimmable option	Driver dependent
LED/m	140
Input	24V DC
LED lifetime	L70 60,000h
Colour rendering Index	CRI>80
Colour consistency	SDCM3

Installation information

Bathroom zone	0, 1 (with dimming)
Construction material	Flexible tape with Silicone coating
Maximum running length	10 m
Weight	234g per meter
Maximum ambient temperature	-20°C - 40°C
Electric class (1, 2, 3)	3

Photometrics @ 25°C

Product code	Reel length	W	CCT	∠	lm	lm/W	Energy
LSNS7327030	3 m	6.5W/m	2700K	120°	290	45	
LSNS7327050	5 m	6.5W/m	2700K	120°	290	45	
LSNS7327100	10 m	6.5W/m	2700K	120°	290	45	
LSNS7330030	3 m	6.5W/m	3000K	120°	310	47	
LSNS7330050	5 m	6.5W/m	3000K	120°	310	47	
LSNS7330100	10 m	6.5W/m	3000K	120°	310	47	
LSNS7340030	3 m	6.5W/m	4000K	120°	315	48	
LSNS7340050	5 m	6.5W/m	4000K	120°	315	48	
LSNS7340100	10 m	6.5W/m	4000K	120°	315	48	

Energy rating is a reflection of the LED light source.

Wiring information

Cable / flying lead	Supplied with 500mm, 0.5mm ² flying lead from one end
Type of wiring required	Parallel

Recommended LED drivers

Product code	Input	SELV	Dimming	Bathroom zone	Products per driver
LSD6024	220-240V	Yes	Yes (with PDCINT 1-10V)	0 (1 when dimming)	9m Max
PS7524	220-240V 50/60Hz	Yes	Yes (with PDCINT 1-10V)	0 (1 when dimming)	11m Max
PSIP15024	220-240V 50/60Hz	Yes	Yes (with PDCINT 1-10V)	0 (1 when dimming)	23m Max

Accessories

LSNS12	Range of connection and fixing accessories	Sold Separately	162
LED STRIP PROFILE RANGE	Profile range to house neon strip	Sold Separately	165



LSNS75

9.6 W/m, IP67, 24V constant voltage, side bend, waterproof flexible neon strip

Features

Strip type	Side bending
IP rating	IP67
CSP switchable	Single CCT
Bespoke lengths	No
Self-adhesive backing	No
Dimmable option	Driver dependent
LED/m	140
Input	24V DC
LED lifetime	L70 60,000h
Colour rendering Index	CRI>80
Colour consistency	SDCM3

Installation information

Bathroom zone	0, 1 (with dimming)
Construction material	Flexible tape with Silicone coating
Maximum running length	5 m
Weight	234g per meter
Maximum ambient temperature	-20°C - 40°C
Electric class (1, 2, 3)	3

Photometrics @ 25°C

Product code	Reel length	W	CCT	∠	lm	lm/W	Energy
LSNS7527030	3 m	9.6W/m	2700K	120°	450	47	
LSNS7527050	5 m	9.6W/m	2700K	120°	450	47	
LSNS7530030	3 m	9.6W/m	3000K	120°	460	48	
LSNS7530050	5 m	9.6W/m	3000K	120°	460	48	
LSNS7540030	3 m	9.6W/m	4000K	120°	470	49	
LSNS7540050	5 m	9.6W/m	4000K	120°	470	49	

Energy rating is a reflection of the LED light source.

Wiring information

Cable / flying lead	Supplied with 500mm, 0.5mm ² flying lead from one end
Type of wiring required	Parallel

Recommended LED drivers

Product code	Input	SELV	Dimming	Bathroom zone	Products per driver
LSD6024	220-240V	Yes	Yes (with PDCINT1-10V)	0 (1 when dimming)	6m Max
LSD12024	220-240V	Yes	Yes (with PDCINT1-10V)	0 (1 when dimming)	12m Max
PSIP25024	220-240V	Yes	Yes (with PDCINT1-10V)	0 (1 when dimming)	26m Max

Accessories

LSNS12	Range of connection and fixing accessories	Sold Separately	162
LED STRIP PROFILE RANGE	Profile range to house neon strip	Sold Separately	165

Strip Lights

9.6W/m Ideal for atmospheric light with 9.6W/m

IP67 Ideal for wet environments with IP67 rating

 Side bending strip

Guarantee

5 years

Features & benefits

500mm flying leads soldered

High quality LED strip maintaining light quality and consistency

Long lengths (LSNS73 up to 10m / LSNS75 up to 5m) suffer no light loss

Cut points are every 50mm

A range of fixing accessories, both rigid and flexible, allowing various installations. Fixing accessories need to be acquired to allow install the neon strip

Has a high-grade silicone extruded coating, UV and Chemicals resistant

Beam angle: 120°

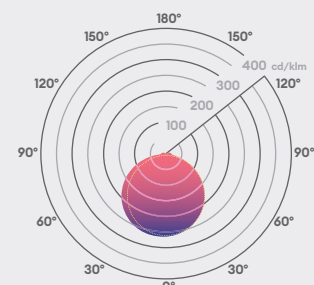

3m,5m/50mm

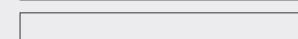

 17mm
12mm

Strip Lights

6.5W/m

Ideal for accent lighting with 6.5W/m

IP67

Ideal for wet environments with IP67 rating



Top bending strip

Guarantee

5 years

Features & benefits

500mm flying leads soldered

High quality LED strip maintaining light quality and consistency

Long lengths (LSNS73 up to 10m / LSNS75 up to 5m) suffer no light loss

Cut points are every 50mm

A range of fixing accessories, both rigid and flexible, allowing various installations. Fixing accessories need to be acquired to allow install the neon strip

Has a high-grade silicone extruded coating, UV and Chemicals resistant

CRI 80 providing true colour appearance

Beam angle: 120°

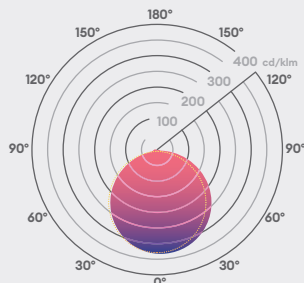

3m,5m,10m/50mm

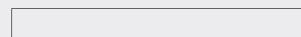

12mm
13mm

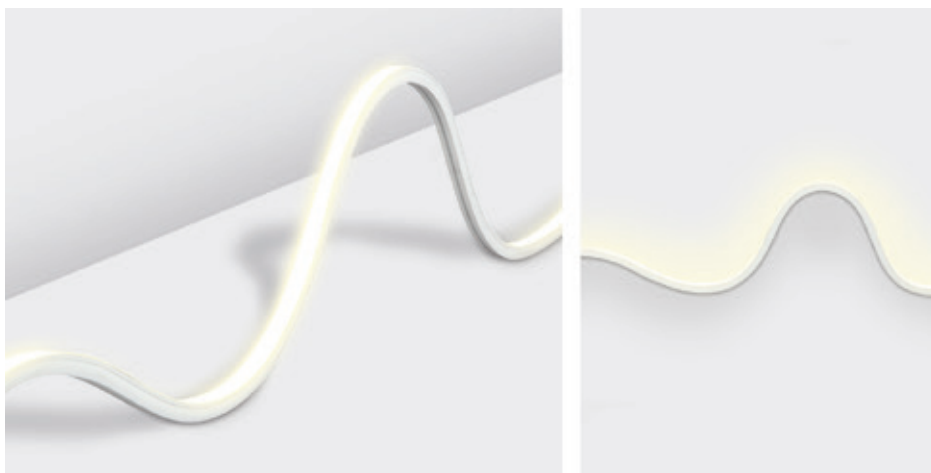

LSNT73

6.5 W/m, IP67, 24V constant voltage, top bend, waterproof flexible neon strip

Features

Strip type	Top bending
IP rating	IP67
CSP switchable	Single CCT
Bespoke lengths	No
Self-adhesive backing	No
Dimmable option	Driver dependent
LED/m	140
Input	24V DC
LED lifetime	L70 60,000h
Colour rendering Index	CRI>80
Colour consistency	SDCM3

Installation information

Bathroom zone	0, 1 (with dimming)
Construction material	Flexible tape with Silicone coating
Maximum running length	10 m
Weight	172g per meter
Maximum ambient temperature	-20°C - 40°C
Electric class (1, 2, 3)	3

Photometrics @ 25°C

Product code	Reel length	W	CCT	∠	lm	lm/W	Energy
LSNT7327030	3 m	6.5W/m	2700K	120°	510	78	
LSNT7327050	5 m	6.5W/m	2700K	120°	510	78	
LSNT7327100	10 m	6.5W/m	2700K	120°	510	78	
LSNT7330030	3 m	6.5W/m	3000K	120°	520	80	
LSNT7330050	5 m	6.5W/m	3000K	120°	520	80	
LSNT7330100	10 m	6.5W/m	3000K	120°	520	80	
LSNT7340030	3 m	6.5W/m	4000K	120°	530	81	
LSNT7340050	5 m	6.5W/m	4000K	120°	530	81	
LSNT7340100	10 m	6.5W/m	4000K	120°	530	81	

Energy rating is a reflection of the LED light source.

Wiring information

Cable / flying lead	Supplied with 500mm, 0.5mm ² flying lead from one end
Type of wiring required	Parallel

Recommended LED drivers

Product code	Input	SELV	Dimming	Bathroom zone	Products per driver
LSD6024	220-240V	Yes	Yes (with PDCINT 1-10V)	0 (1 when dimming)	9m Max
PS7524	220-240V 50/60Hz	Yes	Yes (with PDCINT 1-10V)	0 (1 when dimming)	11m Max
PSIP15024	220-240V 50/60Hz	Yes	Yes (with PDCINT 1-10V)	0 (1 when dimming)	23m Max

Accessories

LSNTI3	Range of connection and fixing accessories	Sold Separately	163
LED STRIP PROFILE RANGE	Profile range to house neon strip	Sold Separately	165

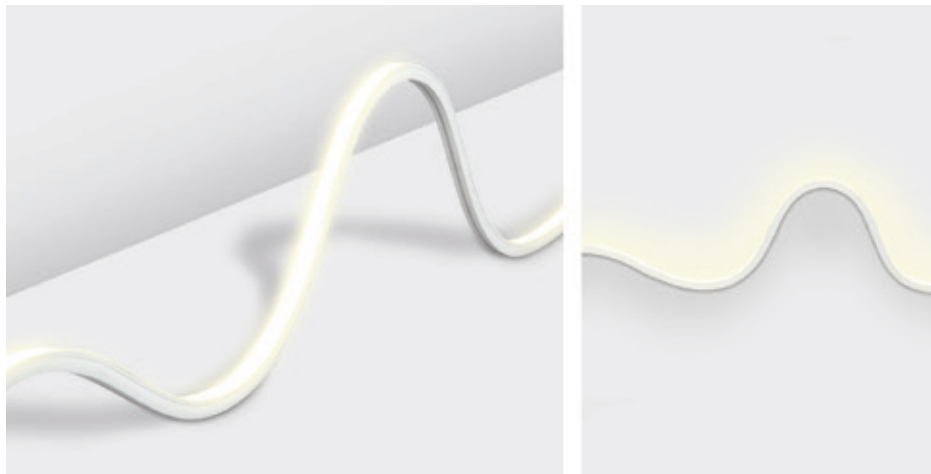

LSNT75

9.6 W/m, IP67, 24V constant voltage, top bend, waterproof flexible neon strip

Features

Strip type	Top bending
IP rating	IP67
CSP switchable	Single CCT
Bespoke lengths	No
Self-adhesive backing	No
Dimmable option	Driver dependent
LED/m	140
Input	24V DC
LED lifetime	L70 60,000h
Colour rendering Index	CRI>80
Colour consistency	SDCM3

Installation information

Bathroom zone	0, 1 (with dimming)
Construction material	Flexible tape with Silicone coating
Maximum running length	5 m
Weight	172g per meter
Maximum ambient temperature	-20°C - 40°C
Electric class (1, 2, 3)	3

Photometrics @ 25°C

Product code	Reel length	W	CCT	∠	lm	lm/W	Energy
LSNT7527030	3 m	9.6W/m	2700K	120°	770	80	
LSNT7527050	5 m	9.6W/m	2700K	120°	770	80	
LSNT7530030	3 m	9.6W/m	3000K	120°	780	81	
LSNT7530050	5 m	9.6W/m	3000K	120°	780	81	
LSNT7540030	3 m	9.6W/m	4000K	120°	792	82	
LSNT7540050	5 m	9.6W/m	4000K	120°	792	82	

Energy rating is a reflection of the LED light source.

Wiring information

Cable / flying lead	Supplied with 500mm, 0.5mm ² flying lead from one end
Type of wiring required	Parallel

Recommended LED drivers

Product code	Input	SELV	Dimming	Bathroom zone	Products per driver
LSD6024	220-240V	Yes	Yes (with PDCINT1-10V)	0 (1 when dimming)	6m Max
LSD12024	220-240V	Yes	Yes (with PDCINT1-10V)	0 (1 when dimming)	12m Max
PSIP25024	220-240V	Yes	Yes (with PDCINT1-10V)	0 (1 when dimming)	26m Max

Accessories

LSNT13	Range of connection and fixing accessories	Sold Separately	163
LED STRIP PROFILE RANGE	Profile range to house neon strip	Sold Separately	165

Strip Lights

9.6W/m Ideal for atmospheric light with 9.6W/m

IP67 Ideal for wet environments with IP67 rating

 Top bending strip

Guarantee

5 years

Features & benefits

500mm flying leads soldered

High quality LED strip maintaining light quality and consistency

Long lengths (LSNS73 up to 10m / LSNS75 up to 5m) suffer no light loss

Cut points are every 50mm

A range of fixing accessories, both rigid and flexible, allowing various installations. Fixing accessories need to be acquired to allow install the neon strip

Has a high-grade silicone extruded coating, UV and Chemicals resistant

Beam angle: 120°

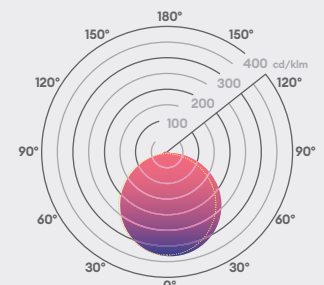

3m, 5m / 50mm

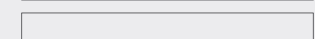

 12mm
13mm

Colour Change



3 Simple steps

Remote to product

Follow the guide below to set up your colour change installation.

Products

What products do you want?

You will need cable to connect your products to your drivers

Drivers

You will need at least one driver per zone, dependant on how many products you would like to install within that zone.

Are you using an RF remote, DMX or DALI control system?

What wattage driver do you need to power your products?



If you want to colour cycle across multiple zones we recommend using power repeaters or for larger projects use DMX drivers.

Remotes

How many zones / rooms do you need?

Which remote covers the number of zones you need?

Is a DMX control system already in place or do you need more than 8 zones? (Use a DMX control system in this case)



It is not advised to put RGB & RGBW products in the same zone, as the colours will not always match.

1 Choose your product

Constant current products



2 Choose control method and driver

Constant current 75W drivers



75W RF, DMX and DALI drivers
See page 182

Constant voltage 24V 100W drivers



100W RF, DMX and DALI drivers
See page 182

Constant Voltage 24V 200W drivers



200W RF, DMX and DALI drivers
See page 182

3 Choose your controller (RF only)



Wall mounted

CCWALLRFW / CCWALLRFB

Zones 1 - 4

Page 180



Hand held

CCREMOTEB

Zones 1 - 4

Page 180



Phone App

CollingwoodRGBW App

Zones 1 - 8

Page 181



CCRFCONWIFI

Page 181

Zones

Remotes

A zone can cover any space you choose. They can be assigned to different areas of your landscape and you can adjust them completely independently from one another using your remote control.

Wall mounted remote control - CCWALLRFW / CCWALLRFB - 1-4 zones

Hand held remote control - CCREMOTEB - 1-4 zones

CollingwoodRGBW app - with CCRFCONWIFI - 1-8 zones

Zone 1

Zone 2

Zone 3

Zone 4

Once you have decided how many zones you require, you will need to select a remote that is capable of covering that number of zones. You are able to use multiple remotes as long as they are all capable of covering the number of zones you have.

Remember you can assign any area to any zone number

CCWALLRFW / CCWALLRFB

Wall mounted RGBW remote control

Controlling Collingwood Lighting's RGB & RGBW ranges could not be easier with this wall mounted remote control. Using radio frequency (RF) removes the need to connect a signal cable to the controller for a cleaner and quicker installation. By simply touching the screen, select solid colours or start a cycle to change the atmosphere. Colours can also be dimmed by holding down the colour button. Select up to 4 zones to give individuality to each room.

Note: The CCWALLRF requires 240V AC supply.



CCREMOTEB

Handheld remote control

Controlling RGB & RGBW lights could not be easier with this remote control. Using RF removes the need to connect a signal cable to the controller for a cleaner and quicker installation. Select solid colours or start a colour changing cycle to create the perfect atmosphere. Colours can also be dimmed by holding down the colour button. From just one remote control you can select up to 4 different rooms and change the colours individually to suit. A maximum of 8 remote controls can be used and programmed to store your favourite colours.

Note: Requires 3 x AAA batteries (not included)



If you require more than 8 zones you will need to use a DMX control system

Zone 5

Zone 6

Zone 7

Zone 8

CollingwoodRGBW App

iPhone, iPad & Android app for wireless control

Control RGB & RGBW products with a smart device for up to 8 zones. By simply touching the screen, select solid colours, start a cycle or control lights via a sound to light option. The app can be downloaded for free on Android and iOS.

Note: Use in conjunction with CCRFCONVWIFI



CCRFCONVWIFI

WiFi to RF converter

Controlling RGB & RGBW products with a phone, computer or tablet could not be easier with the CCRFCONVWIFI. Simply add this unit into your Collingwood Lighting colour change installation and select millions of colours in comfort.











Using the CollingwoodRGBW app simply connect directly to the CCRFCONVWIFI or via your own WiFi.

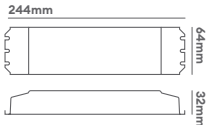

Drivers

Which one and what power supply?

Choose the driver that is required for your installation.

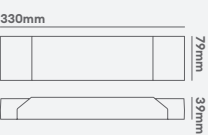
	RF drivers	DMX drivers	DALI drivers	
Which driver type do you need?	RF drivers allow wireless control from a hand-held remote controller, a wall mounted touch panel or a phone app via the Wi-Fi converter. A driver can be paired with up to 8 individual remotes and each remote can control multiple drivers in up to 8 zones.	DMX allows for wired control of up to 128 different zones, and multiple drivers can be assigned to each zone to keep the lights perfectly in sync. These drivers also support RDM for more advanced control and management with RDM-enabled controllers.	Use a DALI driver for integration with an existing DALI control system. These drivers allow for up to 16 RGBW zones or up to 64 single-colour zones on a standard DALI system.	
75W Driver for all RGBW products excluding LED Strip				
	CCDRV75RF	CCDRV75DMX	CCDRV75DALI	
100W Driver For LED Strip only				
	CCDRV100RF	CCDRV100DMX	CCDRV100DALI	
200W Driver For LED Strip only				
	CCDRV200RF	CCDRV200DMX	CCDRV200DALI	



If you want to colour cycle across multiple zones we recommend using power repeaters or for larger projects use DMX drivers.

Constant current switchable mA drivers

All our 75W constant current drivers are mA switchable, giving you 16 options to choose from, 250mA - 1500mA



Drive current mA switches

Calculate how many drivers you need for the products you have

Must have at least one driver per zone. Can have multiple drivers per zone to get more products within the zone.

75W Constant current drivers

Product code	Product family	Max products per 75W driver	Drive current mA setting
GL016RGBW	Ground Light	13	350mA
GL090RGBW	Ground Light	4	350mA
GLTXS119RGBW	Ground Light	4	300mA
GLTXS147RGBW	Ground Light	2	300mA
GLTXS165RGBW	Ground Light	1	300mA
GLTXS193RGBW	Ground Light	3	900mA
GLTXS223RGBW	Ground Light	1	600mA
FOUX167RGBW	Ground Light	1	600mA
UL010RGBW	Pond Light	13	350mA
UL030RGBW	Pond Light	4	350mA
WL070RGBW	Wall Light	1	350mA

100W Constant voltage drivers

200W Constant voltage drivers

Cable run guidance, from controller to products

350mA RGBW products

From power repeater to 350mA product when using **0.5mm cable**, the maximum distance cable run is **50m**

From power repeater to 350mA product when using **0.75mm cable**, the maximum distance cable run is **75m**

From power repeater to 350mA product when using **1.0mm cable**, the maximum distance cable run is **100m**

From power repeater to 350mA product when using **1.5mm cable**, the maximum distance cable run is **150m**

Power repeaters

Which one and how many?

Only required for RF colour cycling

If you are using RF control and you need several different circuits to colour cycle together, you can use power repeaters to extend the output of the driver.

For all constant current products use the PR3011

PR3011 - 350mA RGB & RGBW Power repeater

A 350mA power supply for the RGB & RGBW product range. Simply wire up to 100 PR3011 to a driver for a quick and simple colour change installation, giving you the ability to have as many as 600 luminaires per zone.

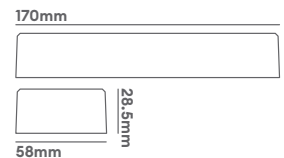

Calculate how many PR3011's you need for the products you have

NOTE: Tilt and Fountain lights are not suitable with PR3011

Product code	Product family	Max. per PR3011
GL016RGBW	Ground Light	6
GL090RGBW	Ground Light	2
UL010RGBW	Pond Light	6
UL030RGBW	Pond Light	2
WL070RGBW	Wall Light	1

For example:

If you had selected these products for your zone.



GL090RGBW



UL030RGBW



GL016RGBW

Using the table to the left we can see that you would need to spread them over the following power repeaters

1st PR3011



2 x GL090RGBW

2nd PR3011



2 x UL030RGBW

3rd PR3011





6 x GL016RGBW

This means you would need to order the following...



PR3011

Don't forget your 24V driver to power your power repeater

Number of power repeaters	Wattage driver needed	Product (driver)
1	60W	LSD6024 
2-3	120W	LSD12024 
4-5	150W	PSIP15024 

The products will be powered by power repeaters that require a 24V driver. The table shows you which driver you need for the number of power repeaters you are using. **If you require more than 5 power repeaters you will need another driver.**

In the example we calculated that we need 3 x PR3011. Using the table to the left we can see that we need a 100W driver. This means that you will need to order the following...



x3 PR3011



x1 LSD12024

Wiring

For your colour change products

You may need additional cables to connect your colour change products.

CR575RGBW

5-core PVC cable

Product code	CR575RGBW
Construction material	Copper cable
Cable	PVC 5 x 0.75mm ²
Guarantee	1 year extended warranty



Use in conjunction with:

All RGBW products	
JB7	212

CF505RGBW

5-core RGBW ribbon cable

Product code	CF505RGBW
Construction material	Copper cable
Cable	(AWG 24) (5 x 0.25mm ²)
Guarantee	1 year extended warranty



Use in conjunction with:

PR3011	184
--------	-----

LEDRGBWEXT

Colour change extension lead for RGBW products

Product code	LEDRGBWEXT
Construction material	Copper cable (PVC)
Cable	1m (AWG 24) (5 x 0.25mm ²)
Series	Series (Plug & Play)
Guarantee	1 year extended warranty



Use in conjunction with:

WL070RGBW	194
-----------	-----

Colour Change



RGBW



Coastal protected



IK08 suitable for pathways

Guarantee

5 years

Features & benefits

Installation tube available

Low profile for easy installation

Separate white LED for permanent use

Compatible with a large range of controllers

Marine grade stainless steel for use in outdoor and indoor environments



GL016RGBW

LED colour change ground light (5W max.)

Features

IK rating	IK09
IP rating	IP67
RGB / RGBW	RGBW
Walk over / Drive over	Walk over (Stainless Steel Only)
Input	350mA
LED lifetime	L50 50,000h
Colour rendering index	CRI>80
Colour consistency	SDCM3

Installation information

Cut out size (mm)	50
Bathroom zone	1
Construction material	Stainless steel (316)
Suitable for coastal areas	Yes
Weight	300g
Maximum ambient temperature	35°C
Electric class (1, 2, 3)	3

Photometrics @ 25°C

Product code	Finish	W	CCT	Beam angle	Im	Im/W	Energy
GL016RGBW	Stainless steel	1.2W	White (4000K)	40°	50	42	
		1W	Red	40°	38	38	
		1.2W	Green	40°	63	53	
		1.2W	Blue	40°	11	9	

Energy rating is a reflection of the LED light source.

Wiring information

Cable / flying lead	2x 1m CR575RGBW (outside diameter: 7.4mm)
Type of wiring required	Series

Control & LED drivers

See pages 180 - 183 for complete control and LED driver offer

Accessories

JB7	5-pole IP68 inline connector	Sold Separately	212
CR575RGBW	5-core PVC cable	Sold Separately	185
TUBE/50	Installation tube	Sold Separately	60
CCRFCONVWIFI / CCREMOTEB / CCWALLRF(B/W)	4/8 zone RF control for RGB & RGBW system	Sold Separately	181

Beam angle: 40°

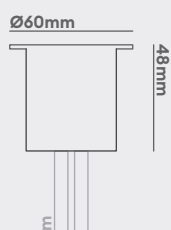
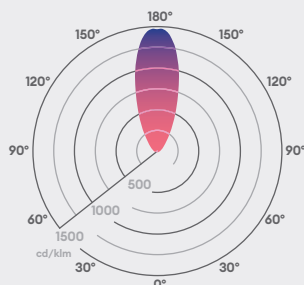



GL090RGBW

High output LED colour change ground light (12W max.)

Features

IK rating	IK08
IP rating	IP67
RGB / RGBW	RGBW
Walk over / Drive over	Walk over (Stainless Steel Only)
Input	350mA
LED lifetime	L50 50,000h
Colour rendering index	CRI>80

Installation information

Cut out size (mm)	70
Bathroom zone	1
Construction material	Stainless steel (316)
Suitable for coastal areas	Yes
Weight	900g
Maximum ambient temperature	35°C
Electric class (1, 2, 3)	3

Photometrics @ 25°C

Product code	Finish	W	CCT	∠°	lm	lm/W	Energy
GL090RGBW	Stainless steel	3W	White (4000K)	45°	177	59	
		2W	Red	45°	106	53	
		3W	Green	45°	185	62	
		3W	Blue	45°	43	14	

Energy rating is a reflection of the LED light source.

Wiring information

Cable / flying lead	2x 1m CR575RGBW (outside diameter: 7.4mm)
Type of wiring required	Series

Control & LED drivers

See pages 180 - 183 for complete control and LED driver offer

Accessories

JB7	5-pole IP68 inline connector	Sold Separately	212
CR575RGBW	5-core PVC cable	Sold Separately	185
TUBE/68	Installation tube	Sold Separately	60
CCRFCNVWIFI / CCREMOTEB / CCWALLRF(B/W)	4/8 zone RF control for RGB & RGBW system	Sold Separately	181

Colour Change



RGBW



Coastal protected



IK08 suitable for pathways

Guarantee

5 years

Features & benefits

High output colour change for large areas

Marine grade stainless steel for use in outdoor and indoor environments

Separate white LED for permanent use

Compatible with a large range of controllers

Beam angle: 45°

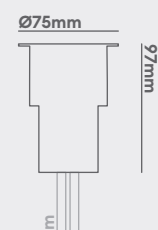
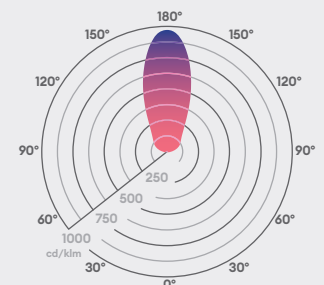





Fountain RGBW

Water feature light

Features

IK rating	IK08
IP rating	IP68
RGB / RGBW	RGBW
Walk over / Drive over	Walk over (Stainless Steel Only)
Input	600mA
LED lifetime	L70 50,000h
Colour rendering index	CRI>80
Colour consistency	SDCM3

Installation information

Cut out size (mm)	167
Bathroom zone	0, 1 (with dimming)
Construction material	316 Stainless Steel
Suitable for coastal areas	Yes
Weight	2.58kg
Maximum ambient temperature	-25°C - 40°C
SELV	Yes
Electric class (1, 2, 3)	3

Photometrics @ 25°C

Product code	Finish	W	CCT	∠°	lm	lm/W	Energy
FOUX167RGBW	Stainless steel 316	13W	White (3000K)	35°	350	40	
		10W	Red	35°	500	40	
		13W	Green	35°	200	15	
		13W	Blue	35°	500	35	

Energy rating is a reflection of the LED light source.

Wiring information

Cable / flying lead	Pre-wired 5.0M H05RN-F, 2x1.0mm ²
Type of wiring required	Series

Control & LED drivers

See pages 180 - 183 for complete control and LED driver offer

Accessories

JB7	5 pole screw terminal IP68 connector	Sold Separately	212
-----	--------------------------------------	-----------------	-----

Colour Change



RGBW



IP68 suitable for full submersion into water



Suitable for coastal C5 and high acid and alkali environment

Guarantee

5 years

Features & benefits

316 Stainless steel housing and titanium cover provides outstanding corrosion resistance

Clear but strong 8mm tempered glass cover provides high efficiency and clear colour accuracy

TRIAC mains dimmable as standard with RGBW option

Pre-wired with 5 metres of cable to aid the installer

To be installed under water to prevent over-heating

1 1/2" BSP thread enables installation onto fabricated pipework

24V version available

Beam angle: 35°

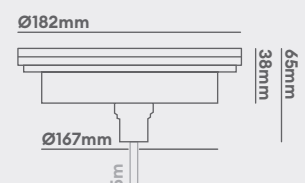
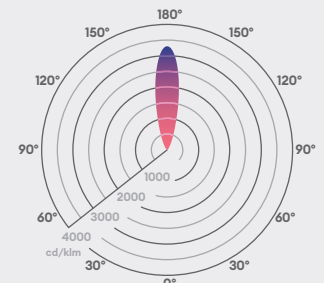

Colour Change



RGBW



Coastal protected



IP67 ideal for outdoor areas and under water lighting

Guarantee

5 years

Features & benefits

Complete with wall fixings for easy installation

Can rotate and be angled to direct light

Separate white LED for permanent use

Compatible with a large range of controllers

Marine grade stainless steel for use in outdoor and indoor environments

Beam angle: 40°

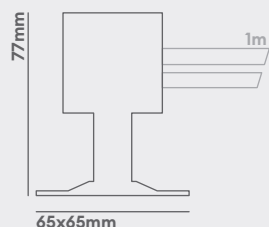
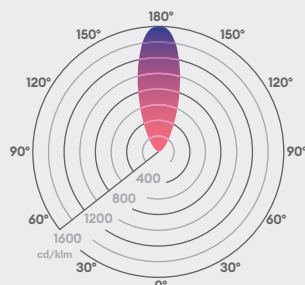

UL010RGBW

Colour change LED light (5W max.)

Features

IP rating	IP67
RGB / RGBW	RGBW
Tilttable	360°
Rotatable	360°
Dimmable	Driver dependent
Input	350mA
LED lifetime	L50 50,000h
Colour rendering Index	CRI>80

Installation information

Bathroom zone	1
Construction material	Stainless steel (316)
Suitable for coastal areas	Yes
Weight	700g
Maximum ambient temperature	35°C
Electric class (1, 2, 3)	3

Photometrics @ 25°C

Product code	Finish	W	CCT	∠°	lm	lm/W	Energy
UL010RGBW	Silver	1.1W	White (4000K)	40°	50	45	
		1W	Red	40°	38	38	
		1.1W	Green	40°	63	57	
		1.1W	Blue	40°	11	8	

Energy rating is a reflection of the LED light source.

Wiring information

Cable / flying lead	2x 1m CR575RGBW (outside diameter: 7.4mm)
Type of wiring required	Series

Control & LED drivers

See pages 180 - 183 for complete control and LED driver offer

Accessories

JB7	5-pole IP68 inline connector	Sold Separately	212
CR575RGBW	5-core PVC cable	Sold Separately	185
CCRFCONVWIFI / CCREMOTEB / CCWALLRF(B/W)	4/8 zone RF control for RGB & RGBW system	Sold Separately	181



UL030RGBW

Colour change LED light (12W max.)

Features

IP rating	IP67
RGB / RGBW	RGBW
Tilttable	360°
Rotatable	360°
Dimmable	Driver dependent
Input	350mA
LED lifetime	L50 50,000h
Colour rendering Index	CRI>80

Installation information

Bathroom zone	1
Construction material	Stainless steel (316)
Suitable for coastal areas	Yes
Weight	900g
Maximum ambient temperature	35°C
Electric class (1, 2, 3)	3

Photometrics @ 25°C

Product code	Finish	W	CCT	∠°	lm	lm/W	Energy
UL030RGBW	Silver	3W	White (4000K)	45°	177	59	
		2W	Red	45°	106	53	
		3W	Green	45°	185	62	
		3W	Blue	45°	43	14	

Energy rating is a reflection of the LED light source.

Wiring information

Cable / flying lead	2x 1m CR575RGBW (outside diameter: 7.4mm)
Type of wiring required	Series

Control & LED drivers

See pages 180 - 183 for complete control and LED driver offer

Accessories

JB7	5-pole IP68 inline connector	Sold Separately	212
CR575RGBW	5-core PVC cable	Sold Separately	185
CCRFCONWIFI / CCREMOTEB / CCWALLRF(B/W)	4/8 zone RF control for RGB & RGBW system	Sold Separately	181

Colour Change



RGBW



Coastal protected



IP67 ideal for outdoor areas and under water lighting

Guarantee

5 years

Features & benefits

Complete with wall fixings for easy installation

Can rotate and be angled to direct light

Separate white LED for permanent use

Compatible with a large range of controllers

Marine grade stainless steel for use in outdoor and indoor environments

Beam angle: 45°

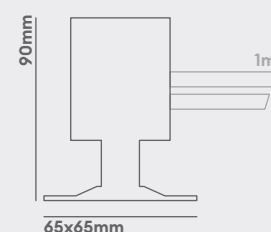
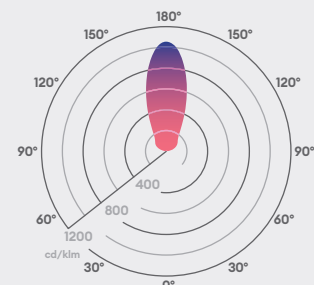

Colour Change



RGBW



IP67 for complete protection against ingress of dust & water



IK10 for protection against high impact

Guarantee

5 years

Features & benefits

Suitable for coastal applications

Tilt angle of luminaire is adjustable, just turn knob to tilt the light distribution up to 25 degrees

Static loading capacity is 2000kg

Pre-wired with 1 meter of cable to aid the installer

TRIAC mains dimmable and DALI-2 dimmable options also available

Supplied with installation tube

Beam angle: 40°

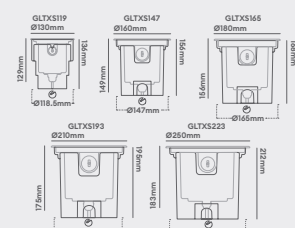
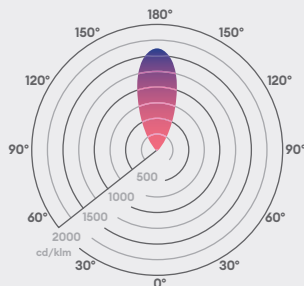

Tilt RGBW ground light

Driverless, RGBW Colour Change

Features

IK rating	IK10
IP rating	IP67
RGB / RGBW	RGBW
Walk over / Drive over	Drive over (15mph maximum)
Input	220-240V AC
LED lifetime	L70 50,000h
Colour rendering index	CRI>80
Colour consistency	SDCM3

Installation information

Cut out size (mm)	119
Bathroom zone	2
Construction material	Anodised aluminium body, 316 SS bezel
Suitable for coastal areas	Yes
Weight	GLTM_11: 0.99kg, GLTM_14: 1.56kg, GLTM_16: 2.03kg, GLTM_19: 3.26kg, GLTM_22: 3.98kg
Maximum ambient temperature	-25°C - 40°C
SELV	N/A
Electric class (1, 2, 3)	3

Photometrics @ 25°C

Product code	Finish	Type	W	CCT	△	lm	lm/W	Energy
GLTXS119RGBW	Stainless steel 316	Ø119mm cut-out	2W	White (3000K)	40°	80	28	
			2W	Red	40°	60	26	
			2W	Green	40°	90	30	
			2W	Blue	40°	30	9	
GLTXS147RGBW	Stainless steel 316	Ø147mm cut-out	4W	White (3000K)	40°	160	28	
			3W	Red	40°	130	30	
			4W	Green	40°	190	37	
			4W	Blue	40°	60	11	
GLTXS165RGBW	Stainless steel 316	Ø165mm cut-out	5.5W	White (3000K)	40°	260	28	
			4.5W	Red	40°	190	30	
			5W	Green	40°	300	37	
			5W	Blue	40°	100	11	

Energy rating is a reflection of the LED light source.

Wiring information

Cable / flying lead	Pre-wired 1.0M H05RN-F, 5x1.0mm ²
Type of wiring required	Series

Control & LED drivers

See pages 180 - 183 for complete control and LED driver offer

Accessories

JB3 or JB7	Junction box	Sold Separately	212
CR575RGBW	5-core PVC cable	Sold Separately	185



Tilt RGBW ground light

Driverless, RGBW Colour Change

Features

IK rating	IK10
IP rating	IP67
RGB / RGBW	RGBW
Walk over / Drive over	Drive over (15mph maximum)
Input	220-240V AC
LED lifetime	L70 50,000h
Colour rendering index	CRI>80
Colour consistency	SDCM3

Installation information

Cut out size (mm)	193
Bathroom zone	2
Construction material	Anodised aluminium body, 316 SS bezel
Suitable for coastal areas	Yes
Weight	GLTM_11: 0.99kg, GLTM_14: 1.56kg, GLTM_16: 2.03kg, GLTM_19: 3.26kg, GLTM_22: 3.98kg
Maximum ambient temperature	-25°C - 40°C
SELV	N/A
Electric class (1, 2, 3)	3

Photometrics @ 25°C

Product code	Finish	Type	W	CCT	Beam angle	lm	lm/W	Energy
GLTXS193RGBW	Stainless steel 316	Ø193mm cut-out	9W	White (3000K)	40°	360	28	
			7W	Red	40°	275	33	
			9W	Green	40°	400	37	
			9W	Blue	40°	150	12	
GLTXS223RGBW	Stainless steel 316	Ø223mm cut-out	11.5W	White (3000K)	40°	510	28	
			9W	Red	40°	380	39	
			12W	Blue	40°	190	13	

Energy rating is a reflection of the LED light source.

Wiring information

Cable / flying lead	Pre-wired 1.0M H05RN-F, 5x1.0mm ²
Type of wiring required	Series

Control & LED drivers

See pages 180 - 183 for complete control and LED driver offer

Accessories

JB3 or JB7	Junction box	Sold Separately	212
CR575RGBW	5-core PVC cable	Sold Separately	185

Colour Change



RGBW

IP67

IP67 for complete protection against ingress of dust & water

IK10

IK10 for protection against high impact

Guarantee

5 years

Features & benefits

Suitable for coastal applications

Tilt angle of luminaire is adjustable, just turn knob to tilt the light distribution up to 25 degrees

Static loading capacity is 2000kg

Pre-wired with 1 meter of cable to aid the installer

TRIAC mains dimmable and DALI-2 dimmable options also available

Supplied with installation tube

Beam angle: 40°

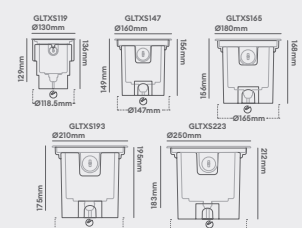
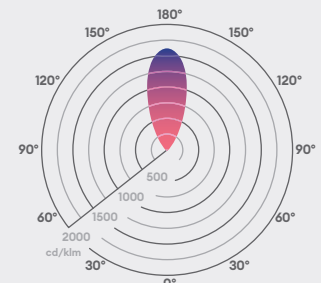

Colour Change



RGBW



Coastal protected



IP65 ideal for outdoor environments

Guarantee

5 years

Features & benefits

Complete with wall fixings for easy installation

Projects light in two directions

Separate white LED for permanent use

Anodised aluminium for use in outdoor and indoor environments

Compatible with a large range of controllers

Beam angle: 45°

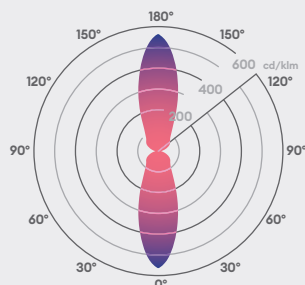

117mm

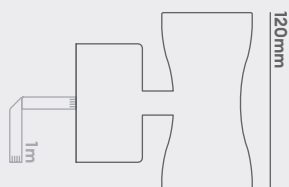

WL070RGBW

Up / down LED colour change wall light (24W max.)

Features

IP rating	IP65
RGB / RGBW	RGBW
Tilttable	No
Rotatable	No
Dimmable	No
Input	350mA
LED lifetime	L50 50,000h
Colour rendering Index	CRI>80
Colour consistency	SDCM3

Installation information

Bathroom zone	1
Construction material	Anodised aluminium
Suitable for coastal areas	Yes
Weight	0.9kg
Maximum ambient temperature	35°C
Electric class (1, 2, 3)	3

Photometrics @ 25°C

Product code	Finish	W	CCT	△	lm	lm/W	Energy
WL070RGBW	Silver	6W	White (4000K)	45°	200	67	
		4.0W	Red	45°	145	73	
		6.0W	Green	45°	230	77	
		6.0W	Blue	45°	38	13	

Energy rating is a reflection of the LED light source.

Wiring information

Cable / flying lead	1x 5-core ribbon cable
Type of wiring required	Series

Control & LED drivers

See pages 180 - 183 for complete control and LED driver offer

Accessories

JB7	5 pole screw terminal IP68 connector	Sold Separately	212
CR575RGBW	5-core PVC cable	Sold Separately	185
LEDRGBWEXT	Colour change Plug & Play 1m extension lead	Sold Separately	185
CCRFCONVWIFI / CCREMOTEB / CCWALLRF(B/W)	4/8 zone RF control for RGB & RGBW system	Sold Separately	181



Lighting Controls



Drivers

The ideal driver for every installation

We offer a wide range of drivers, suitable for any environment that are ideal for all Collingwood Lighting products, so you can expect the highest levels of quality and durability throughout your installation.

IP ratings

IP ratings classify the degrees of protection provided against the intrusion of solid objects and water in electrical enclosures.

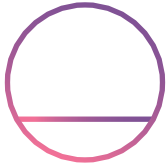

IP20

Perfect for use indoors and where there is no risk of water splashing the product.



IP44

Ideal for use indoors or outdoors, in bathrooms and other places where water may be sprayed onto the product.

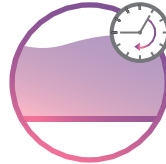

IP67

Suited for use outdoors and near water, but cannot be permanently submerged.

PSIP drivers

We have redesigned our range of IP65 rated drivers that are used with our low voltage landscape products. 350mA and 700mA options are available and wattage range has been extended to allow for more fittings per driver. The drivers also now come with an increased warranty of five years.



Dimming options

As each installation is unique and has individual requirements, choose between mains, 1-10V or DALI dimming options.

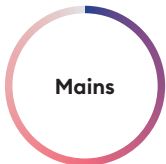

Mains

If your product has an integrated mains dimmable driver, no separate driver is required. This is classed as a 'straight to mains' product.

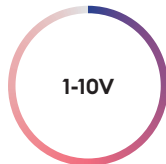

1-10V

With a 1-10V system, all the LEDs connected to the dimmer will dim at an equal amount.



DALI

A DALI system can be structured in a way which allows LEDs to respond to certain rooms or zones. Each LED in the same zone will dim an equal amount.

Plug & play

Installing and connecting a driver is made much easier using plug and play. If you have a suitable product, use one of our plug and play drivers for straightforward installation.

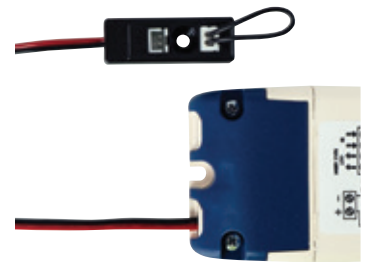

Output classification options – constant current / constant voltage

Constant current LED drivers are designed to deliver a constant output current within a specified output voltage range. Such drives adjust the voltage throughout the circuit and keep the current on each LED constant.

Constant voltage LED drivers are designed to operate at a single, constant output voltage. The most commonly used constant voltage sources are 12 V and 24 V. The constant voltage LED driver takes the mains voltage (220 V AC) and converts it to DC, reducing it to the appropriate low voltage value for the LEDs. The drive will always remain at constant voltage, no matter how much current load. The maximum current that constant voltage drives can reach is determined by the design parameters and this value is written on the driver.

350mA

Use a 350mA driver when powering 350mA products.

700mA

Use a 700mA driver when powering 700mA products.

24V

Use a 24V driver when powering 24V products.

Colour change

Making controlling colour easier

Use our easy to follow step-by-step colour change control guide on pages **178 - 179** and follow the guide to determine what you need for your installation.

Controllers

Offering a choice between hand held, wall mounted or app control, finding the perfect device for you couldn't be easier. Choose the ideal control for the number of zones that you want to manage. See **180 -181** about zones.



CCWALLRFW / CCWALLRFB

1-4 zones
Wall mounted control



CCREMOTEB

1-4 zones
Handheld control



CollingwoodRGBW App

1-8 zones
Smart device app for Android & iOS



CCRFCONWIFI

WiFi to RF converter

Drivers

Use the drivers to control your RGBW products, with various options available, RF, DMX or DALI all in 75W, 100W and 200W.



Constant current 75W drivers



Constant voltage 100W drivers



Constant voltage 200W drivers

RF drivers allow wireless control from a hand-held remote controller, a wall mounted touch panel or a phone app via the Wi-Fi converter. **DMX** driver allows for wired control of up to 128 different zones, and multiple drivers can be assigned to each zone to keep the lights perfectly in sync.

Use a **DALI** driver for integration with an existing DALI control system.

Power repeater

A power repeater can be used to extend the capacity of a driver.



PR3011

Ideal for when using constant current products. With the ability to fit up to 100 of these to a driver, you can have as many as 600 luminaires per zone.

Products per driver matrix

The table shows the minimum and maximum of each products that fits onto each driver.

	PS1524	PS3024B	PSMD3024	LSD6024	PSDIP6024	PS7524	PSDIP10024	PSMDIP10024	LSD12024	PSIP15024	PSDAL20024	PSIP25024	DRV350700TD (350mA & 500mA)
Driver information													
Constant current or Constant voltage	CV	CV	CV	CV	CV	CV	CV	CV	CV	CV	CV	CV	CC
Output classification	24V	24V	24V	24V	24V	24V	24V	24V	24V	24V	24V	24V	350mA-500mA
IP rating	IP20	IP20	IP20	IP20	IP66	IP20	IP66	IP66	IP20	IP67	IP66	IP67	IP20
Dimmable	1-10V*	1-10V*	Mains	No	1-10V	1-10V*	1-10V	Mains	No	1-10V*	1-10V	1-10V*	Mains (Triac)
DIN rail mount	No	No	No	No	No	No	No	No	No	No	No	No	No
Plug & Play	No	No	No	No	No	No	No	No	No	No	No	No	No

Decorative													
LED LYTE IP Page 117													4-14
LED LYTE IPT Page 118													4-14
ML01 Page 116													4-14

Strip													
LSC82 Page 168	3.1m	6.2m	3.8-6.2m	12.5m	12.5m	15.6m	20.8m	20.8m	25m	31.2m	41.6m	52m	
LSC84 Page 170	1m	2m	1.3-2m	4.1m	4.1m	5.2m	6.9m	6.9m	8.3m	10.4m	13.8m	17.3m	
LSC85 Page 169	1.5m	3.1m	1.9-3.1m	6.2m	6.2m	7.8m	10.4m	10.4m	12.5m	15.6m	20.8m	26m	
LSC86 Page 171	0.8m	1.7m	1.1-1.7m	3.5m	3.5m	4.4m	5.8m	5.8m	7m	8.8m	11.7m	14.7m	
LSNS73 Page 172	2.3m	4.6m	2.8-4.6m	9.2m	9.2m	11.5m	15.3m	15.3m	18.4m	23m	30.7m	38.4m	
LSNS75 Page 173	1.5m	3.1m	1.9-3.1m	6.2m	6.2m	7.8m	10.4m	10.4m	12.5m	15.6m	20.8m	26m	
LSNT73 Page 174	2.3m	4.6m	2.8-4.6m	9.2m	9.2m	11.5m	15.3m	15.3m	18.4m	23m	30.7m	38.4m	
LSNT75 Page 175	1.5m	3.1m	1.9-3.1m	6.2m	6.2m	7.8m	10.4m	10.4m	12.5m	15.6m	20.8m	26m	

To place an order use the driver product codes below.

DRV150700 (150mA-350mA)	DRV150700 (400mA-700mA)	DRV350700TD (700mA)	PLD UNI-DRIVE 350MA	PSDAL350M	PSDIM350	PSIP3509W	PSIP35018W	PLDM70011	PLD UNI-DRIVE 700MA	PSDAL700M	PSDIM700	PSIP70018W	PSIP70036W	PSDAL900M	PSDIM900	PSDIM180
CC	CC	CC	CC	CC	CC	CC	CC	CC	CC	CC	CC	CC	CC	CC	CC	CC
150mA-350mA	400mA-700mA	700mA	350mA	350mA	350mA	350mA	350mA	700mA	700mA	700mA	700mA	700mA	700mA	900mA	900mA	180mA
IP20	IP20	IP20	IP20	IP20	IP20	IP65	IP65	IP20	IP20	IP20	IP20	IP65	IP65	IP20	IP20	IP20
No	No	Mains (Triac)	1-10V	DALI or 1-10V	1-10V	No	No	Mains	1-10V	DALI or 1-10V	1-10V	No	No	DALI	1-10V	Mains
No	No	No	No	No	No	No	No	No	No	No	No	No	No	No	No	No
No	No	No	No	No	No	No	No	Yes	No	No	No	No	No	No	No	Yes

*Requires a PDCINT1-10V interface to make it 1 - 10V dimmable

1-15			1-10	1-18	1-18	1-8	9-17									
1-15			1-10	1-18	1-18	1-8	9-17									
1-15			1-10	1-18	1-18	1-8	9-17									

Products per driver matrix

The table shows the minimum and maximum of each products that fits onto each driver.

	PS1524	PS3024B	PSMD3024	LSD6024	PSDIP6024	PS7524	PSDIP10024	PSMDIP10024	LSD12024	PSIP15024	PSDAL20024	PSIP25024	DRV350700TD (350mA & 500mA)
Driver information													
Constant current or Constant voltage	CV	CV	CV	CV	CV	CV	CV	CV	CV	CV	CV	CV	CC
Output classification	24V	24V	24V	24V	24V	24V	24V	24V	24V	24V	24V	24V	350mA-500mA
IP rating	IP20	IP20	IP20	IP20	IP66	IP20	IP66	IP66	IP20	IP67	IP66	IP67	IP20
Dimmable	1-10V*	1-10V*	Mains	No	1-10V	1-10V*	1-10V	Mains	No	1-10V*	1-10V	1-10V*	Mains (Triac)
DIN rail mount	No	No	No	No	No	No	No	No	No	No	No	No	No
Plug & Play	No	No	No	No	No	No	No	No	No	No	No	No	No

Landscape													
BOL01 Page 126													4-14
FOUX167N30 Page 101		1-1		1-2	1-2	1-3	1-4		1-4	1-6		1-10	
GL016 Page 45													3-12
GL016 Frosted Page 46													4-14
GL018 Page 24	1-30	1-60	36-60	1-120	1-120	1-150	1-200	1-200	1-240	1-300	1-400	1-500	
GL019 Page 27													3-12
GL019 Frosted Page 28													3-12
GL021 Page 70													4-14
GL022 Page 71													4-14
GL034 Page 67													2-6
GL038 Page 58													2-6
GL040 Page 52													2-6
GL040 Frosted Page 53													3-12
GL100 Page 34													3-12
SL030 Page 80													4-14
SL040A Page 81													
SL130 Page 80													4-14
SL220 Page 82													2-6
SL230 Page 86													1-3
SL230 Single Head Page 84													2-6
Spydra Page 90													2-4
UL010 Page 100													3-12
UL030 Page 99													2-6

To place an order use the driver product codes below.

DRV150700 (150mA-350mA)	DRV150700 (400mA-700mA)	DRV350700TD (700mA)	PLD UNI-DRIVE 350MA	PSDAL350M	PSDIM350	PSIP3509W	PSIP35018W	PLDM70011	PLD UNI-DRIVE 700MA	PSDAL700M	PSDIM700	PSIP70018W	PSIP70036W	PSDAL900M	PSDIM900	PSDIM180
CC	CC	CC	CC	CC	CC	CC	CC	CC	CC	CC	CC	CC	CC	CC	CC	CC
150mA-350mA	400mA-700mA	700mA	350mA	350mA	350mA	350mA	350mA	700mA	700mA	700mA	700mA	700mA	700mA	900mA	900mA	180mA
IP20	IP20	IP20	IP20	IP20	IP20	IP65	IP65	IP20	IP20	IP20	IP20	IP65	IP65	IP20	IP20	IP20
No	No	Mains (Triac)	1-10V	DALI or 1-10V	1-10V	No	No	Mains	1-10V	DALI or 1-10V	1-10V	No	No	DALI	1-10V	Mains
No	No	No	No	No	No	No	No	No	No	No	No	No	No	No	No	No
No	No	No	No	No	No	No	No	Yes	No	No	No	No	No	No	No	Yes

*Requires a PDCINTI-10V interface to make it 1 - 10V dimmable

1-15	1-14	4-9	1-10	1-18	1-18	1-8	9-17		1-10	1-18	1-18	1-8	9-17			
1-13	1-13	3-8	1-17	1-24	1-24	1-7	8-16		1-14	1-23	1-23	1-7	8-16			
1-15			1-10	1-18	1-18	1-8	9-17									
1-13	1-13	3-8	1-17	1-24	1-24	1-7	8-16		1-14	1-23	1-23	1-7	8-16			
1-13			1-16	1-23	1-23	1-7	8-15									
1-15			1-10	1-18	1-18	1-8	9-17									
1-15			1-10	1-18	1-18	1-8	9-17									
1-6	1-6	2-4	1-8	1-12	1-12	1-4	5-8		1-7	1-11	1-11	1-3	4-7			
1-6	1-6	2-4	1-8	1-12	1-12	1-4	5-8		1-7	1-11	1-11	1-3	4-7			
1-6	1-6	2-4	1-8	1-12	1-12	1-4	5-8		1-7	1-11	1-11	1-3	4-7			
1-13			1-16	1-23	1-23	1-7	8-15									
1-13	1-13	3-8	1-17	1-24	1-24	1-7	8-16		1-14	1-23	1-23	1-7	8-16			
1-15	1-14	4-9	1-10	1-18	1-18	1-8	9-17		1-10	1-18	1-18	1-8	9-17			
	1-4	2-3							1-3	1-6	1-6	1-2	3-5			
1-15	1-14	4-9	1-10	1-18	1-18	1-8	9-17		1-10	1-18	1-18	1-8	9-17			
1-6	1-6	2-4	1-8	1-12	1-12	1-4	5-8		1-7	1-11	1-11	1-3	4-7			
1-3	1-3	1-2	1-4	1-6	1-6	1-2	3-4		1-3	1-5	1-5	1-1	2-3			
1-6	1-6	2-4	1-8	1-12	1-12	1-4	5-8		1-7	1-11	1-11	1-3	4-7			
1-4	1-4	1-2	1-3	1-5	1-5	1-2	3-5		1-4	1-7	1-7	1-2	3-5			
1-13	1-13	3-8	1-17	1-24	1-24	1-7	8-16		1-14	1-23	1-23	1-7	8-16			
1-6	1-6	2-4	1-8	1-12	1-12	1-4	5-8		1-7	1-11	1-11	1-3	4-7			

Products per driver matrix

Choose the right power repeater and driver

Colour change

For all constant current products you will need the **PR3011**.

Once you know how many products will be installed in your zone use the relevant tables to work out how many power repeaters you will need and which driver to power them.

Do this for each zone

Power repeater comparison

Choose the right power repeater and driver

	Constant current / Constant Voltage	Rated wattage	Input current	Input voltage	Output current	Output voltage	Ambient temperature (TA=°C)	Case temperature (TC=°C)	Control
PR3011	CC	4 x 8.4W max.	1.6A max.	24V DC	4 x 350mA	4 x 24V max.	40°C	70°C	CCDRV100___ CCDRV200___

Dimming interface

Choose the right dimming interface

	Type of interface	Rated wattage	Input current	Input voltage	Output current	Output voltage	Power factor	Ambient temperature (TA=°C)	Case temperature (TC=°C)	Control	Double insulation	Efficiency	IP rating
PDCINTI-10V	1-10V for 24V drivers	288W	12A max.	24V DC	12A max.	24V DC	-25°C to 40°C	-25°C - 40°C	70°C	DALI-2, PUSH DIM, 0-10V and 1-10V		99%	IP20

The products will be powered by power repeaters that require a 24V driver. The table below shows which driver is needed for the number of power repeaters being used.

Products per PR3011		Products per PR3011		PR3011's per driver		
Product code	Max. per PR3011	Product code	Max. per PR3011	Number of PR3011's	Wattage driver required	Product (driver)
GL016RGBW	6	WL070RGBW	1	1	60W	LSD6024
GL090RGBW	2	UL010RGBW	6	2 - 3	120W	LSD12024
		UL030RGBW	2	4 - 5	150W	PSIP15024

IP rating	Loop in / loop out	Din rail mount	Protection	Dimensions	Weight	Connections	Accessories	Warranty
IP20	Yes		Short circuit & overheating	H: 28.5 mm L: 170 mm W: 58 mm	165g	Screw terminals < 2.5mm ² cable		5 years guarantee

Inrush current	Loop in / loop out	Din rail mount	Protection	SELV	Dimensions	Weight	Connection output	Input cable	Output cable	Accessories	Warranty
					H: 28mm L: 138mm W: 40mm	80g	Terminals	4mm ² max.	1.5mm ² max.		1 year

Driver comparison

For full driver specifications visit our website collingwoodlighting.com

	Rated wattage (Output)	Output voltage	Output current	Input wattage (Maximum)	Input voltage	Input current (Maximum)	Inrush current	Power factor	Ambient temperature (TA=°C)	Control	Double insulation	Efficiency	IP rating	Plug & Play
EUP30TIHMC0	30W	3-40V DC	750mA	30W	220-240VAC, 50-60Hz	0.17A	15A	0.9	-20°C - 50°C	Mains		87%	IP20	Yes
LSD12024	120W	24V DC	5A max	120W	220-240VAC, 50-60Hz	0.64A	36A 0.183ms	0.9	-15°C - 45°C	Dimmable with PDCINTI-10V	Yes	90%	IP20	No
LSD6024	60W	24V DC	2.5A max	60W	220-240VAC, 50-60Hz	0.32A	37A 0.215ms	0.9	-15°C - 45°C	Dimmable with PDCINTI-10V	Yes	>89%	IP20	No
DRV150700	30W	2.5-42VDC	150-700mA	30W	220-240VAC	150mA-700mA	5.38A 0.032ms	0.95	45°C	Non-dimmable	Yes	89%	IP20	
DRV350700TD	20W	350mA: 9-40V - 500mA: 9-40V - 700mA: 9-29V	350-700mA	20W	220-240VAC	350-700mA	15A 0.09ms	0.95	50°C	Mains (Triac)	Yes	81%	IP20	
PLD UNI-DRIVE 350MA	N/A	2-46V	350mA	18W	110-240V AC	0.14A	5A 0.05ms	0.98	-25°C - 50°C	1-10V	Yes	80%	IP20	
PLD UNI-DRIVE 700MA	N/A	2-36V	700mA	30W	110-240V AC	0.14A	5A 0.05ms	0.98	-25°C - 50°C	1-10V	Yes	80%	IP20	
PLDM70011	N/A	12V	700mA	12W	220-240V AC	0.05A	15A 0.5ms	0.95	-25°C - 40°C	Mains	Yes	>80%	IP20	Yes
PS1524	15W	24V DC	0.625A max.	18W	220-240V AC	0.08A	28A 0.02ms	0.5	45°C	Dimmable with PDCINTI-10V	Yes	>84%	IP20	
PS3024B	30W	24V DC	1.25A max	36W	220-240V AC	0.24A	20A 0.78ms	0.9	-20°C - 45°C	Dimmable with PDCINTI-10V	Yes	>80%	IP20	
PS250600MA	25W	14-42V	250mA - 600mA	29W	220-240VAC, 50-60Hz	0.18A	40A 0.35ms	0.95	-20°C - 45°C	DALI, 0-10V, PUSH DIM	Yes	85%	IP20	No

Loop in / loop out	Din rail mount	Protection	SELV	Dimensions	Weight	Connection output	Input cable	Output cable	Accessories	Warranty
			Yes	H: 42.5mm L: 185mm W: 28.5mm	150g	Terminals	0.75- 2.5mm ²	0.75- 2.5mm ²		3 Years
No	No	Mains Surge, Short / Open Circuit	Yes	H: 30mm L: 300mm W: 40mm	425g	Terminals	0.75 - 1.5mm ²	0.75 - 1.5mm ²		5 years
No		Mains Surge, Short / Open Circuit	Yes	H: 30mm L: 180mm W: 52mm	296g	Terminals	0.75 - 1.5mm ²	0.75 - 1.5mm ²		5 years
	No	Open Circuit, Short Circuit, Over Temperature Self Reset	Yes	H: mm L: mm W: mm		Push-fit terminals		0.75 - 1.5mm ²		5 years
	No	Open Circuit, Short Circuit, Over Temperature Self Reset	Yes	H: mm L: mm W: mm	130g	Push-fit terminals				5 Years
	No	Short circuit, overload & overheating	Yes	H: 22mm L: 103mm W: 67mm	100g	Terminals	0.5-1.5mm ² max.	0.5-1.5mm ² max.		5 years
	No	Short circuit, overload & overheating	Yes	H: 22mm L: 103mm W: 67mm	100g	Terminals	0.5-1.5mm ² max.	0.5-1.5mm ² max.		5 years
	No	Open circuit & short circuit	Yes	H: 28mm L: 78mm W: 50mm	70g	Plug & Play	0.15m, 0.75mm ² 2-core cable	AWG24 with plug & play connector		7 years
	No	Short circuit, overload & overheating	Yes	H: 19mm L: 103mm W: 35.5mm	80g	Terminals	0.5-1.5mm ² max.	0.5-1.5mm ²	PDCINT1-10V Dimming interface	3 Years
	No	Short circuit, overload & overheating	Yes	H: 30mm L: 143mm W: 45mm	146g	Terminals	0.5-1.5mm ² max.	0.5-1.5mm ²	PDCINT1-10V Dimming interface	3 Years
No		Over Voltage, Short Circuit, Thermal	Yes	H: 30mm L: 125mm W: 76mm	190g	DC Plug and Play Connector	0.75 - 1.5mm ²	0.5 - 1.5mm ²		5 years

Driver comparison

For full driver specifications visit our website collingwoodlighting.com

	Rated wattage (Output)	Output voltage	Output current	Input wattage (Maximum)	Input voltage	Input current (Maximum)	Inrush current	Power factor	Ambient temperature (TA=°C)	Control	Double insulation	Efficiency	IP rating	Plug & Play
PS6501100MA	46W	14-42V	650mA - 1100mA	53W	220-240VAC, 50-60Hz	0.3A	40A 0.35ms	0.95	-20°C - 45°C	DALI, 0-10V, PUSH DIM	Yes	87%	IP20	No
PS7524	75W	24V DC	3.13A max.	90W	200-240V AC	0.4A	75A 0.11ms	0.9	-20°C - 45°C	Dimmable with PDCINT1-10V	Yes	85%	IP20	
PSDAL20024	200W	24V DC	8.33A max.	240W	220-240V AC	1.4A	56A 640µs	0.98	-25°C - 50°C	DALI	Yes	>85%	IP66	
PSDAL350M	N/A	2-74V	350mA	30W	110-240V AC	0.25A	20A 0.4ms	0.95	-25°C - 50°C	1-10V & DALI	Yes	90%	IP20	
PSDAL700M	N/A	2-71V	700mA	56W	110-240V AC	0.25A	20A 0.4ms	0.95	-25°C - 50°C	1-10V & DALI	Yes	90%	IP20	
PSDAL900M	N/A	2-55V	900mA	56W	110-240V AC	0.25A	20A 0.4ms	0.95	-25°C - 50°C	1-10V & DALI	Yes	>80%	IP20	
PSDIM180	N/A		180mA	8.5W	220-240V AC	0.038A	20A 0.4ms	0.9	-25°C - 50°C	Mains	Yes	74%	IP20	Yes
PSDIM350	N/A	2-74V	350mA	30W	110-240V AC	0.25A	20A 0.4ms	0.95	-25°C - 50°C	1-10V	Yes	>80%	IP20	
PSDIM700	N/A	2 - 71V	700mA	56W	110-240V AC	0.25A	20A 0.4ms	0.95	-25°C - 50°C	1-10V	Yes	80%	IP20	
PSDIM900	N/A	2-55V	900mA	56W	110-240V AC	0.25A	20A 0.4ms	0.95	-25°C - 50°C	1-10V	Yes	>80%	IP20	
PSDIP10024	100W	24V DC	4.15A max.	120W	220-240V AC	0.546A	45A 0.7ms	0.98	40°C	0-10V	Yes	>80%	IP66	

Loop in / loop out	Din rail mount	Protection	SELV	Dimensions	Weight	Connection output	Input cable	Output cable	Accessories	Warranty
No		Over Voltage, Short Circuit, Thermal	Yes	H: 30mm L: 125mm W: 76mm	190g	DC Plug and Play Connector	0.75 - 1.5mm ²	0.5 - 1.5mm ²		5 years
	No	Short circuit, overload, overheating & over voltage	Yes	H: 28.2mm L: 170mm W: 44.5mm	221g	Terminals	0.5-1.5mm ² max.	0.5-1.5mm ²		3 Years
	No	Short circuit, overload & overheating	Yes	H: 53mm L: 255mm W: 80mm	1800g	Flying Lead	Mains: 0.25m, 1mm ² 3-core cable Ø: 7.5mm DALI: 0.25m, 0.75mm ² 2-core cable Ø: 7mm	0.25m, 1.5mm ² 2-core cable Ø 9mm		3 Years
	No	Short circuit, overload & overheating	Yes	H: 22mm L: 123mm W: 79mm	100g	Terminals	0.5-1.5mm ² max.	0.5-1.5mm ² max.		5 years
	No	Short circuit, overload & overheating	Yes	H: 22mm L: 123mm W: 79mm	100g	Terminals	0.5-2.5mm ² max.	0.5-2.5mm ² max.		5 years
	No	Short circuit, overload & overheating	Yes	H: 22mm L: 123mm W: 79mm	100g	Terminals	0.5-2.5mm ² max.	0.5-2.5mm ² max.		7 years
Yes	No	Open / Short Circuit - Power Cycle Reset	Yes	H: 30mm L: 118mm W: 46mm	103g	Plug & Play		H03VVH2-F with connector		3 Years
	No	Short circuit, overload & overheating	Yes	H: 22mm L: 123mm W: 79mm	100g	Terminals	0.5-2.5mm ² max.	0.5-2.5mm ² max.		5 years
	No	Short circuit, overload & overheating	Yes	H: 22mm L: 123mm W: 79mm	100g	Terminals	0.5-2.5mm ² max.	0.5-2.5mm ² max.		7 years
	No	Short circuit, overload & overheating	Yes	H: 22mm L: 123mm W: 79mm	100g	Terminals	0.5-2.5mm ² max.	0.5-2.5mm ² max.		7 years
	No	Short circuit, overload & overheating	Yes	H: 44mm L: 230mm W: 68mm	1200g	Flying Lead	Mains: 0.25m, 1mm ² 3-core cable Ø: 7.5mm 1-10V: 0.25m, 0.75mm ² 2-core cable Ø: 6.5mm	0.25m, 1.5mm ² 2-core cable Ø: 7mm		3 Years

Driver comparison

For full driver specifications visit our website collingwoodlighting.com

	Rated wattage (Output)	Output voltage	Output current	Input wattage (Maximum)	Input voltage	Input current (Maximum)	Inrush current	Power factor	Ambient temperature (TA±°C)	Control	Double insulation	Efficiency	IP rating	Plug & Play
PSIP15024	150W	24V DC	6.3A max.	178W	220-240V AC	0.80A	45A 1ms	0.95	50°C	Dimmable with PDCINT1-10V	Yes	>85%	IP67	
PSIP25024	250W	24V DC	10.4A max.	285W	220-240V AC	1.6A	30A 0.2ms	0.96	50°C	Dimmable with PDCINT1-10V	Yes	84%	IP67	
PSIP35018W	18W	25 - 50V	350mA	20W	220-240V AC	0.1A	13A 0.1ms	0.9	50°C	Non-dimmable	Yes	83%	IP65	
PSIP3509W	9W	2.5 - 25V	350mA	11W	220-240V AC	0.05A	8A 0.1ms	0.9	50°C	Non-dimmable	Yes	82%	IP65	
PSIP70018W	18W	2.5 - 25V	700mA	20W	220-240V AC	0.1A	12A 0.1ms	0.9	50°C	Non-dimmable	Yes	83%	IP65	
PSIP70036W	36W	25 - 50V	700mA	40W	220-240V AC	0.18A	18A 0.1ms	0.9	50°C	Non-dimmable	Yes	85%	IP65	
PSMD3024	30W	24V DC	1.25A	30W	180-240V AC	0.18A	3A 0.08ms	0.95	50°C	Mains	Yes	>83%	IP20	
PSMDIP10024	100W	24V DC	4.17A max.	120W	180-264V AC	0.8A	30A 0.2ms	0.6		Mains	Yes	85% with max load	IP66	

Loop in / loop out	Din rail mount	Protection	SELV	Dimensions	Weight	Connection output	Input cable	Output cable	Accessories	Warranty
	No	Short circuit, overload & overheating	Yes	H: 37mm L: 190mm W: 62mm	1200g	Flying Lead	0.25m, 1mm ² 3-core cable Ø: 7.5mm	0.25m, 1mm ² 2-core cable Ø 8mm	PDCINT1-10V Dimming interface	3 Years
	No	Short circuit, overload & over current	Yes	H: 36mm L: 220mm W: 62mm	875g	Flying Lead	0.25m, 1mm ² 3-core cable Ø: 7.5mm	0.25m, 2mm ² 2-core cable Ø: 9mm	PDCINT1-10V Dimming interface	3 Years
	No	Short circuit, overload & overheating	Yes	H: 25mm L: 180mm W: 42mm	200g	Flying Lead	0.2m, 1mm ² 2-core cable Ø: 7mm	0.2m, 1mm ² 2-core cable Ø: 7mm		5 years
	No	Short circuit, overload & overheating	Yes	H: 24mm L: 160mm W: 38mm	200g	Flying Lead	0.2m, 1mm ² 2-core cable Ø: 7mm	0.2m, 1mm ² 2-core cable Ø: 7mm		5 years
	No	Short circuit, overload & overheating	Yes	H: 24mm L: 160mm W: 38mm	200g	Flying Lead	0.2m, 1mm ² 2-core cable Ø: 7mm	0.2m, 1mm ² 2-core cable Ø: 7mm		5 years
	No	Short circuit, overload & overheating	Yes	H: 25mm L: 180mm W: 42mm	250g	Flying Lead	0.2m, 1mm ² 2-core cable Ø: 7mm	0.2m, 1mm ² 2-core cable Ø: 7mm		5 years
	No	Short circuit, overload & overheating	Yes	H: 45mm L: 185mm W: 65mm	450g	Terminals	0.75-4.0mm ² max.	0.5-4.0mm ² max.		3 Years
	No	Short circuit, overload & over current	Yes	H: 43mm L: 230mm W: 70mm	1300g	Flying Lead	0.25m, 1mm ² 3-core cable Ø: 7.5mm	0.25m, 1mm ² 2-core cable Ø: 7mm		1 Year Warranty

Accessories

For accessories specific to product ranges visit the relevant sections.

JB1 (Parallel)

Waterproof junction box



Key features		Use in conjunction with	
Max. voltage	30V DC	GL018	
Max. current	5A		
Max. conductor size	1mm ²		
Cable diameter	5 - 6.5mm ²		
IP rating	IP68 (2m)		
Wiring	Parallel		
Inputs	1		
Outputs	1 - 3		

JB3

Waterproof junction box



Key features		Use in conjunction with	
Max. voltage	400V AC	GL016RGBW	GL090RGBW
Max. current	30A		
Max. conductor size	4mm ²		
Cable diameter	3 - 12mm ²		
IP rating	IP66		
Wiring	Parallel		
Inputs	1		
Outputs	1 - 7		

JB5 (Parallel)

Gel filled waterproof junction box



Key features		Use in conjunction with	
Max. voltage	250V AC	BL03	GL018
Max. current	16A	GL034	GL038
Max. conductor size	1.5mm ²	GL200	WL339
Cable diameter	6.5 - 12mm ²	WL341	
IP rating	IP68 (1.3m)		
Wiring	Parallel		
Inputs	1		
Outputs	1 - 3		

JB7

5 pole screw terminal IP68 connector



Key features (RGBW only)		Use in conjunction with	
Max. voltage	24V	GL016RGBW	GL090RGBW
Max. current	1.4A		
Max. conductor size	4mm ²		
Cable diameter	7 - 10.5mm ²		
IP rating	IP68 (1.3m)		
Wiring	Parallel		
Inputs	1		
Outputs	1		

JB2 (Series)

Waterproof junction box



Key features		Use in conjunction with		
Max. voltage	48V DC	BL01	GL016	GL019
Max. current	700mA	GL021	GL022	GL040
Max. conductor size	1mm ²	UL010	UL030	SL030
Cable diameter	5 - 6.5mm ²	SL130	SL040	SL220
IP rating	IP68 (2m)	GL100		
Wiring	Series			
Inputs	1			
Outputs	1 - 3			

JB4 (Series)

Gel filled waterproof junction box



Key features		Use in conjunction with		
Max. voltage	120V DC	BL01	GL016	GL019
Max. current	700mA	GL021	GL022	GL040
Max. conductor size	1.5mm ²	UL010	UL030	SL030
Cable diameter	3 - 12mm ²	SL130	SL040	SL220
IP rating	IP66	GL100		
Wiring	Series			
Inputs	1			
Outputs	1 - 7			

JB6

Inline IP68 gel filled cable connector



Key features		Use in conjunction with
Max. voltage	250V AC	WCR 275 BLACK
Max. current	6A	Ideal for extending cable when it's not long enough
Max. conductor size	0.75mm ²	
Cable diameter	4.8 - 6mm ²	
IP rating	IP68 (1.3m)	
Wiring	Inline	
Inputs	1	
Outputs	1	

WC 5-9

Quick release waterproof connector



Key features (RGBW only)		Use in conjunction with	
Max. voltage	250 AC / 50 DC	BL03	GL034
Max. current	10A	GL038	GL200
Max. conductor size	4mm ²	SL220	WL339
Cable diameter	5 - 9mm ²	WL340	WL341
IP rating	IP68 (1.3m)	WL342	
Wiring	Inline		
Inputs	1		
Outputs	1		

WCR 275 Black

2-core rubber cable



Key features

Cable H05RN-F 2 x
0.75mm²
Outer diameter 6mm

Material Copper cable,
rubber outer

Length 100m reel

**Indoor /
outdoor** Suitable for permanent outdoor use

Use in conjunction with

JB1 JB2

JB4 JB6

WCR 375 Black

3-core rubber cable



Key features

Cable H05RN-F 3 x
0.75mm²
Outer diameter 6mm

Material Copper cable,
rubber outer

Length 100m reel

**Indoor /
outdoor** Suitable for permanent outdoor use

Use in conjunction with

JB1 JB5

WC 5-9

UY2 Connector

Quick waterproof connector



Key features

IP rating IP65

Wiring Series

Waterproof type Gel

Material Plastic

Use in conjunction with

ML01

Maximum cable lengths

Use the tables below for the maximum cable length

The lengths below are guidelines which cover most installations. If an installation requires a longer cable length, it may be possible but a calculation will be needed to confirm it. Please contact our technical support team for further information.

All wiring must comply with national wiring regulations

Constant current drivers

Cable length in metres is from the driver to the last LED unit.
The number of LED's units wired to the driver does not affect the cable length.

Driver	0.2mm ²	0.35mm ²	0.5mm ²	0.75mm ²	1mm ²	1.5mm ²	2.5mm ²
350mA drivers	50m	80m	100m	150m	200m	300m	500m
700mA drivers	25m	40m	50m	75m	100m	150m	250m

Maximum length for a 350mA driver using 1.5mm² cable is 300 metres of 2 core cable using one core for feed and the second core for return.

Single colour 24V DC LED strip (LSC, Neon)

Recommended maximum cable length from power supply to **start** of strip.

Driver	0.5mm ²	0.75mm ²	1mm ²	1.5mm ²	2.5mm ²
4.8W/m	20m	30m	40m	60m	100m
6.5W/m	16m	25m	32m	50m	80m
8W/m	13m	20m	26m	40m	65m
9.6W/m	10m	15m	20m	30m	50m
14.4W/m	7m	10m	15m	20m	35m
17W/m	6m	9m	12m	18m	30m

Above figures are for a 5m strip length. For a 2.5m strip length, for example, the maximum cable length is x 2.

RGBW products

Maximum cable lengths from power repeater to product.

Power repeater	0.5mm ²	0.75mm ²	1mm ²	1.5mm ²	2.5mm ²
PR3011	50m	75m	100m	150m	250m

GL018 0.5W 24V DC drivers

Cable length is from the driver to the last LED unit.

Max product per driver	0.5mm ²	0.75mm ²	1mm ²	1.5mm ²	2.5mm ²
Up to 10 - GL018	100m	180m	220m	360m	550m
Up to 20 - GL018	50m	90m	110m	180m	225m
Up to 30 - GL018	35m	60m	70m	120m	180m
Up to 40 - GL018	25m	40m	50m	80m	130m

Information

Lighting terms

0-10V

Dimming controlled by a variable voltage that allows the light to be dimmed to 0%.

1-10V

Dimming controlled by a variable voltage, with control from 10%-100% brightness.

AC (alternating current)

An electrical current which changes direction periodically.

Accent lighting

Aesthetic lighting that provides emphasis, depth and decoration to draw attention to particular objects.

Ambient temperature

Ambient temperature relates to the average air temperature in the environment surrounding the luminaire / LED driver.

Bathroom zone

Suitability for a product to be installed near or in water.

CCT

Correlated Colour Temperature.

Colour switchable

Colour temperature can be switched between 3000K to 4000K or 6000K / 6500K.

CRI

Colour Rendering Index.

DALI

Digital Addressable Lighting Interface. A method of digital dimming, allowing precise control of individual light fittings by an external control system.

DC (direct current)

An electrical current flowing in one direction only.

Dim to warm

The CCT becomes warmer as the product is dimmed.

Flicker

A visible constant fluctuation of light output from on to off.

IK rating

Indicates the protection against mechanical impact. Rated from IK00 to IK10.

Insulation coverable

Insulation can be laid directly on top of the product this can refer to rolled or blown wool insulation.

IP rating

Ingress Protection Rating.

Kelvin (K)

Kelvin is the scientific unit for measuring CCT (Correlated Colour Temperature).

L70, B10 / L70, B50

Lifetime indication of the LEDs. L represents the percentage of lumens at the lifetime hours and B represents the failure rate to meet L. L70, B10 at 50,000 hours means that at 50,000 hours, the LED keeps 70% of its light output and 10% have failed to do so.

Leading edge dimmers

The electrical current (sinusoidal signal) is turned off at the front of the AC input waveform immediately after the zero crossing.

Lumens (lm)

The quantity of light emitted from a light source that is visible. The higher the lumens, the brighter the light.

Luminaire

Is a light fitting that contains a light source, mechanical fixings and a power supply.

Luminous efficacy

Is a measure of energy efficiency and is calculated by dividing the lumens by the wattage (lm/W).

Luminous flux

Total number of 'lumens' emitted from a light source.

Lux (lx)

Quantity of light that illuminates a surface, e.g. in a corridor 100 lux are required on the floor.

Maintained

Maintained fittings are on all the time, like a normal luminaire.

mA

A milliamp is one thousandth of an amp (0.001A). Collingwood products are typically designed to take 350mA, 700mA, 900mA.

Manual test

The battery of tests need to be conducted by an individual, or team, on each relevant product.

Microwave sensor

A presence sensor to reduce the amount of time lighting is left on unnecessarily.

Non maintained

Non-maintained fittings only turn on in the event of a power failure.

PIR

Passive Infrared Device, used to activate lighting when a person enters a room or area.

PUSH-DIM

Dimming control via a single push button, press briefly for on/off and hold to dim up/down.

PWM

Pulse-width modulation: a control system for efficient and precise control of brightness, mainly used for strip.

RAL

A set of industry standard colours to ensure consistent paint finishes across all products.

REACH

Registration, Evaluation, Authorisation & Restriction of Chemicals. All Collingwood products are REACH compliant.

RGBW

Stands for Red, Green, Blue, White. Used to describe colour changing products that can be used to dynamically add colour to any environment. Can also be run on white when natural lighting is required.

RGBWW

RGBWW: This is a 5-in-1 LED chip that contains a warm white, RGB and cool white element.

RoHS

Restriction of Hazardous Substances, an EU requirement that restricts the use of harmful materials within products. All Collingwood products are RoHS compliant.

Self Test

Self-test products have built in technology that facilitates an automation of testing regimes.

SELV

Separated Extra Low Voltage. A low voltage power supply that will not exceed 50V AC or 120V DC.

Task lighting

Describing the installation or retrofit of LED downlights or other lighting specifically to provide functional illumination of an environment.

Thermal management

LEDs are susceptible to heat. Thermal management refers to components that are designed to remove heat efficiently to ensure high light output and long lifetime from the LEDs.

Trailing edge dimmers

The electrical current (sinusoidal signal) is turned off at the end of the AC input waveform immediately before the zero crossing.

UGR

UGR stands for Unified Glare Rating. The lower the value, the more comfortable the environment.

WEEE

Waste Electrical and Electronic Equipment, Collingwood is part of a WEEE scheme. Our WEEE Registration: WEE/JC3973RV

Wiring / electrical terms

Extension leads

Ready-made leads for easy extension of cables, usually with male / female plugs for Plug & Play extensions.

Flying leads

Electrical leads already attached to the product.

HO5RN-F

Electrical cable suitable for outdoor use.

Pattness box

Back box for electrical front plates.

Plug & play

Cables on product have 1 x male and 1 x female plugs attached for quick connection.

PTFE

A non-stick, chemically resistant insulating material.

RCD

Residual Current Device. This is a type of circuit breaker, which detects electrical leakage.

Shielded cable

Inner wires are wrapped in a shielding material to protect from electrical interference.

Straight to mains

Product for which no other wiring is required other than connection to the mains supply.

Information

Series / parallel wiring

LED lighting products can be wired in either Series or Parallel and both have their advantages.

Series

Series wired products that require a separate constant current driver.

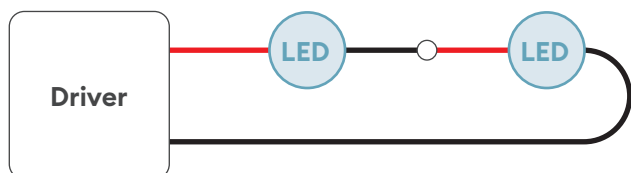

Parallel

Parallel wired products that require a separate constant voltage driver.

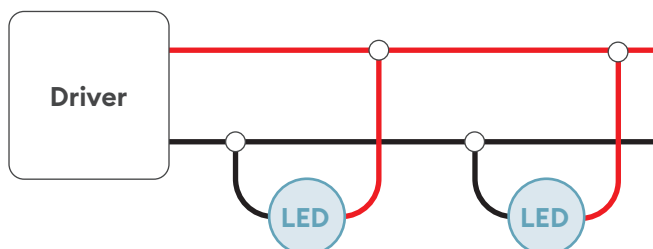

Building regulations

Specifically related to the UK, the following building regulations should be complied with, where appropriate.

Part B - Fire protection

When a hole is cut into a fire barrier (e.g. a fire rated ceiling), an appropriately fire-resistant luminaire must be used to block the hole from any pathway in the event of a fire in the room. All Collingwood downlights are fire rated and designed around our patented fire-resistant technology.

Part C - Moisture protection

When a hole is cut in an insulation barrier (e.g. a ceiling tile or plaster ceiling), air and moisture can travel into the ceiling void. Part C rated downlights can assist in energy saving by preventing heat loss from a room. The H4 Pro range are the only Part C rated adjustable downlights available in the market.

Part E - Acoustic protection

In multi-floor buildings, such as hotels and apartment blocks, sound can permeate throughout the building causing annoyance to neighbours and colleagues. With a Part E rated downlight, testing is carried out to ensure it is resistant to sound being transferred through partitions.

Part P - Electrical safety

Covers all aspects of proper installation of electrical components. All Collingwood products have been designed to easily allow installation to Part P, but we recommend that they should be installed by a qualified electrician or a suitably competent person.

Part L - Conservation of energy

LEDs are an energy efficient technology, however not all LED products are created equal. Part L ensures that only the most efficient products are installed, so that as little energy as possible is used, and therefore energy bills are lowered.

New or existing Dwellings: each internal light fitting should have lamps with a minimum luminous efficacy of 75 light source lumens per circuit-watt.

Buildings other than dwellings: General lighting, has an average luminaire efficacy of 95 luminaire lumens per circuit-watt
Display lighting, have an average light source efficacy of 80 light source lumens per circuit-watt

SDCM (standard deviation colour matching)

SDCM refers to the colour consistency between light sources. SDCM is a different naming convention for MacAdam Ellipses, both terms are internationally accepted. A SDCM is a scientific term given to light sources that the human eye should not be able to distinguish a difference between in an installation.

Collingwood Lighting commits to ensuring that its illumination products have colour consistency.

SLR / ELR Overview

Single Lighting and Energy Labelling Regulations

The Single Lighting Regulation (SLR) came into effect on the 1st September 2021, across Europe and includes the UK. The Energy Labelling Regulation (ELR) is also came into effect at the same time, which means that, amongst other things, the label has been rescaled from A** - E to A - G. What was an A++ class is now an E class!

The SLR regulations are aimed at improving product performance across the lighting industry, including all types of lighting technology. Energy efficiency requirements mean that Compact Fluorescent Lamps (CFLs) and T8 fluorescent lamps are banned. LED lighting technology is the main option to ensuring compliance with these requirements.

In addition to the product performance requirements, the regulations also encourage elements of the circular economy concept. Light sources and control gears must be produced so that they can be easily removed and replaced with commonly available tools, unless there is a technical justification why this cannot happen (e.g. IP rating).

Collingwood ground lights, would be an example of a product that meets the technical justification. The IP rating required for these fittings means that they are sealed for life and that replacement of the light source would not be acceptable to maintain product performance.

We have designed our products to ensure conformance with these regulations, whilst not compromising on performance, lifetime or warranty.

Please contact us should you have any questions regarding a specific product.

Industry standard pictograms

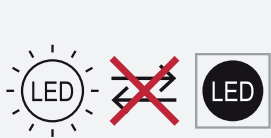

Non-replaceable light source

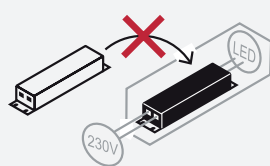

Non-replaceable control gear

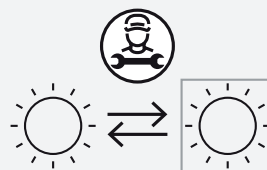

Replaceable light source by a professional

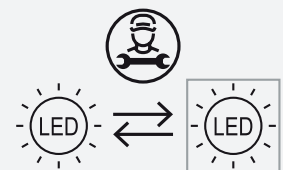

Replaceable (LED only) light source by a professional

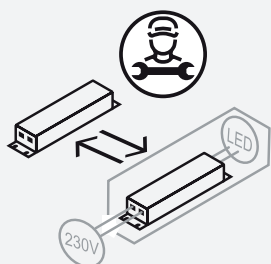

Replaceable control gear by a professional

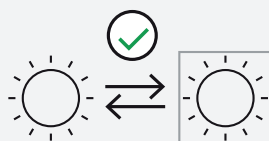

Replaceable light source by an end-user

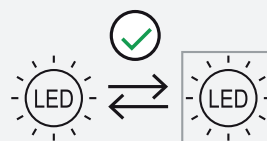

Replaceable (LED only) light source by an end-user

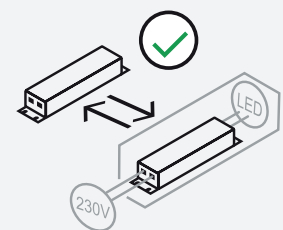

Replaceable control gear by an end-user

CCT (correlated colour temperature)

Choosing a colour temperature:

LEDs make it possible to have a choice of white colours or 'tones'. This allows easy customisation of an area to bring out the best in the materials and design of a room.

With standard white LED lighting, these tones range from warm-yellow to cool-blue white light, with several options in between. The graphic below is a reference that starts at a warm yellow colour on the left and fades into a cool blue colour on the right.

Collingwood Lighting uses the industry standard Correlated Colour Temperature (CCT) rating to describe the tones of white light available.

The standard unit of CCT is the kelvin (K), so CCT is described as a 'temperature'. CCT options range from 6500K cool white, 4000K natural white, 3000K warm white, 2700K warmer white and 2200K ember.

You will find colour consistency across our entire range of products ensuring seamless installations.

It can be tricky to decide what is best for your installation, but our skilled technical sales and lighting design teams are on hand to guide you through choosing the perfect white tone for your room.

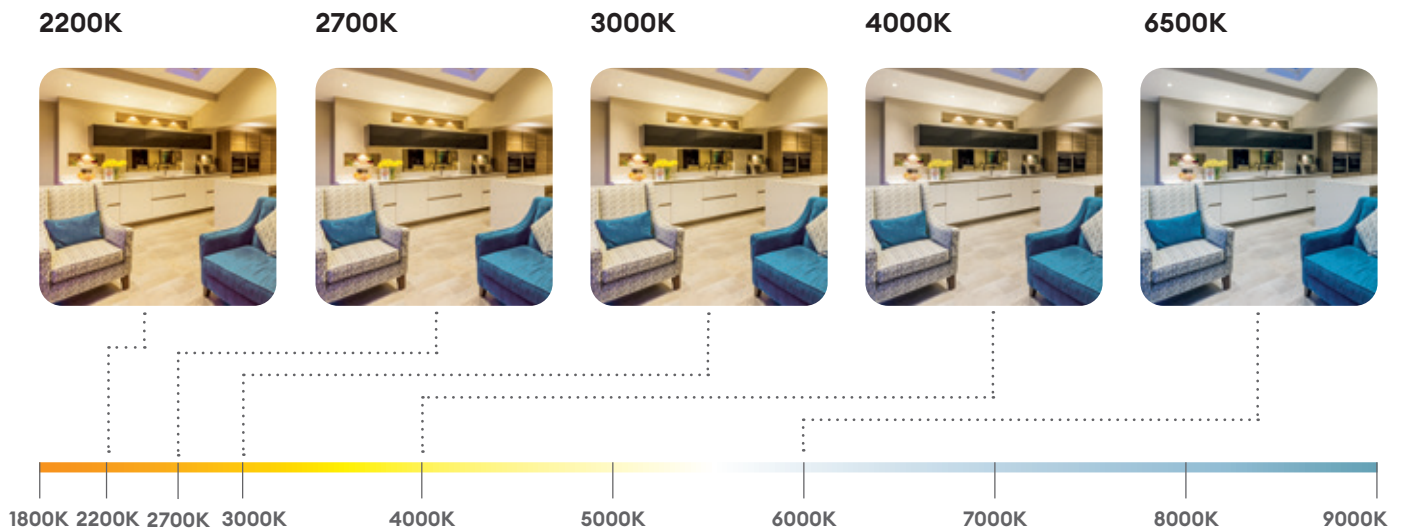

Beam angles

25° A narrow beam angle ideal for illuminating specific areas of interest with pin points of light.

38° The most commonly used beam angle since the introduction of the halogen lamp in the '70s. Ideal for illuminating large areas and space between fittings is normally 1m-1.2m to create an even spread of light at floor level. Commonly used throughout residential and commercial environments.

45° Can be used instead of a 38° beam angle when the ceiling is higher than standard or when looking to achieve a greater spread of light at floor and wall level. Commonly used in the hospitality market.

60° This wider beam angle allows for greater spacing between fittings, up to 1.8m apart, or greater illumination at 1.2m spacings, meaning fewer luminaires are required. Also produces a more even spread of light at floor and wall level. Commonly used throughout residential and commercial environments.

Ideal for high ceilings and illuminating large areas of space
80° and is more commonly used in the commercial sector.

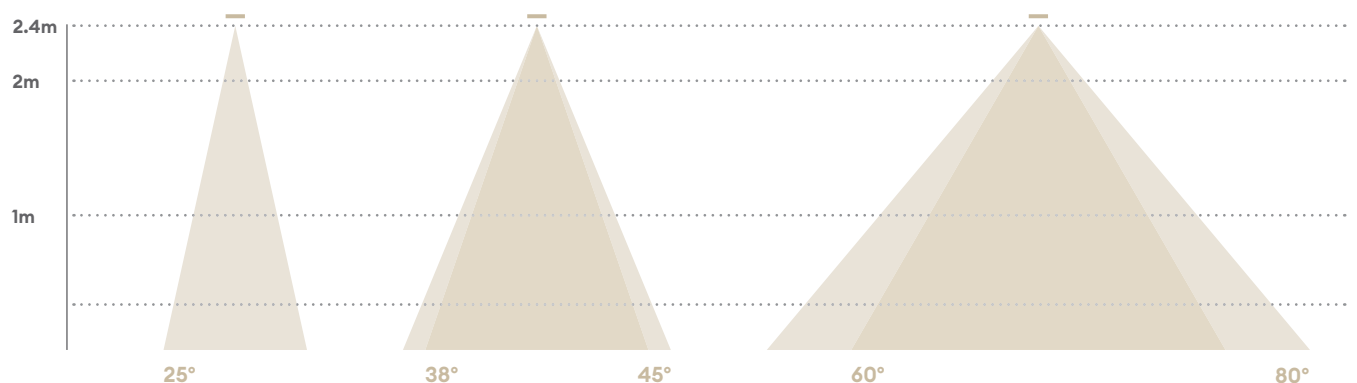

CRI (colour rendering index)

A value given to the quality of a light source with regards to how accurately it can replicate colours compared to natural daylight. CRI is given as a value out of 100, and is stated as the Rendering Index (Ra).

LEDs are generally available with a CRI of between 50Ra and 95Ra, with those in the lower end used for outdoor lighting, and those in the higher end used for professional photography.

It is generally accepted that a CRI of >80Ra is very good and for general indoor lighting, while >90Ra is used in specialised locations, e.g. retail or very high-end hospitality.



Low CRI



High CRI

RGB vs RGBW

Use RGB products to select vivid red, green or blue schemes or mix the three together for even more colour options.

The addition of a white LED in RGBW products provides the option to create pastel shades and white, in addition to the vivid red, green and blue colours.

RGBW can also be run on white, giving you the option of more natural lighting when it is required. Choose from 2700K, 3000K and 4000K.

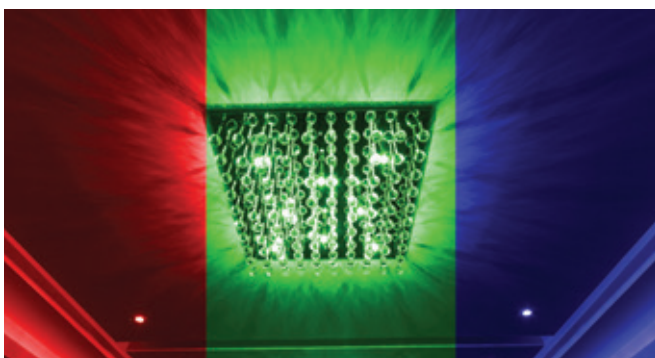

RGB



RGBW

DIALux RELUX®

Collingwood Lighting is partnered with DIALux and RELUX 3D lighting design software which provides fast and accurate calculations and detailed, realistic visualisations of designs.

Our entire e-catalogue is available in our plug-in, giving you the freedom to select any product and add it to your virtual design. This will create an accurate representation of your lighting scheme, giving you the ability to get creative with your design and accomplish the perfect lighting scheme - with no regrets after installation.

LED lifetime / light output

LEDs do not use heat to generate light in the same way as commonly used lights, where 80% of the power used is dissipated as heat. This is why LEDs are referred to as cool to touch and are safer to use, especially in ground light products. However an LED does have an operating temperature within its structure. This heat, if not removed will reduce the light output and product lifetime. This is why LED products have heatsinks or use the body of the product to dissipate the heat as quickly and efficiently as possible.

Many Collingwood LED products have visible heatsinks: these are typically made from anodised aluminium and feature many thin fins. It is essential to have an air gap around the heatsink, as this ensures that heat is quickly removed, which keeps the LED at optimum temperature.

LEDs do naturally lose their ability to produce light over many thousands of hours so Collingwood Lighting publishes the expected lifetime of products within its catalogue. This helps customers to easily determine how long the product will last,

and to calculate how much energy will be saved compared to conventional incandescent lamps over the life of the product. Use the cost savings calculator on our website to see our estimate of how much our lights can save you compared to non-LEDs. Lifetime is stated as the number of hours of operation until the light level emitted from the LEDs has dropped to a specified percentage of the original published values.

For the majority of Collingwood Lighting products, lifetime is stated as 'L70, B10 X hours'. Where, 'L70' means 70% of original light output remains. 'B10' means that 10% of products will have reached this level (i.e. 90% of products will have a light output greater than 70% of published) after 'X' number of hours of operation.

As an example, the majority of Collingwood Lighting products state lifetime as L70, B10 for 70,000 hours. However, as LEDs do naturally lose their ability to emit light, they will continue to operate for many hundreds of hours after this level has been reached, but at an ever-reducing level.

IK rating

Degrees of protection against external mechanical impacts.

Number	Protection	Number	Protection
IK00	Not protected.	IK06	Protected against 1 joules impact.
IK01	Protected against 0.14 joules impact.	IK07	Protected against 2 joules impact.
IK02	Protected against 0.2 joules impact.	IK08	Protected against 5 joules impact.
IK03	Protected against 0.35 joules impact.	IK09	Protected against 10 joules impact.
IK04	Protected against 0.5 joules impact.	IK10	Protected against 20 joules impact.
IK05	Protected against 0.7 joules impact.		

IP rating

The IP rating normally has two numbers:

1. Level of protection from solid objects or materials.
2. Level of protection from liquids (water).

Solid protection

Number	Example	Protection
0		No special protection.
1		Protection from a large part of the body such as a hand (but no protection from deliberate access); from solid objects greater than 50mm in diameter.
2		Protection against fingers or other objects not greater than 80mm in length and 12mm in diameter.
3		Protection from entry by tools, wires etc, with a diameter of 2.5mm or more.
4		Protection against solid bodies larger than 1mm.
5		Protection against dust that may harm equipment.
6		Totally dust-tight.

Liquid protection

Number	Example	Protection
0		No special protection.
1		Protection against condensation.
2		Protection against water droplets deflected up to 15° from vertical.
3		Protection against spray up to 60° from vertical.
4		Protection against water spray from all directions.
5		Protection against low pressure water jets (all directions).
6		Protection against high pressure water jets and waves.
7		Protection against temporary immersion.
8		Protection against prolonged effects of submersion under pressure. Submersion depth to be specified.*
9		Protection against high pressure, high temperature close range jet (8-10 MPa – 80°C) and high temperature water and steam.

IP65

Ingress protection.

*e.g. IP 68 @ 1bar = dust-tight and permanent protection to 1 bar pressure (9m water depth).

Bathroom / pool zones

What IP rating do I need?

Zone 0 \geq IPX7

Only 12V AC rms or 30V ripple-free DC SELV, transformers must be sited outside Zones 0,1,2.

Zone 1 \geq IPX4

Only 25V AC or 60V DC ripple-free SELV. Where water jets are likely to be used for cleaning purposes in communal baths & showers at least IPX5 is required.

Zone 2 \geq IPX4

Protected by 30mA RCD. Where water jets are likely to be used for cleaning purposes in communal baths & showers at least IPX5 is required.

Outside zones 0, 1 & 2

No specific IP rating. Where water jets are likely to be used for cleaning purposes in communal baths & showers at least IPX5 is required.

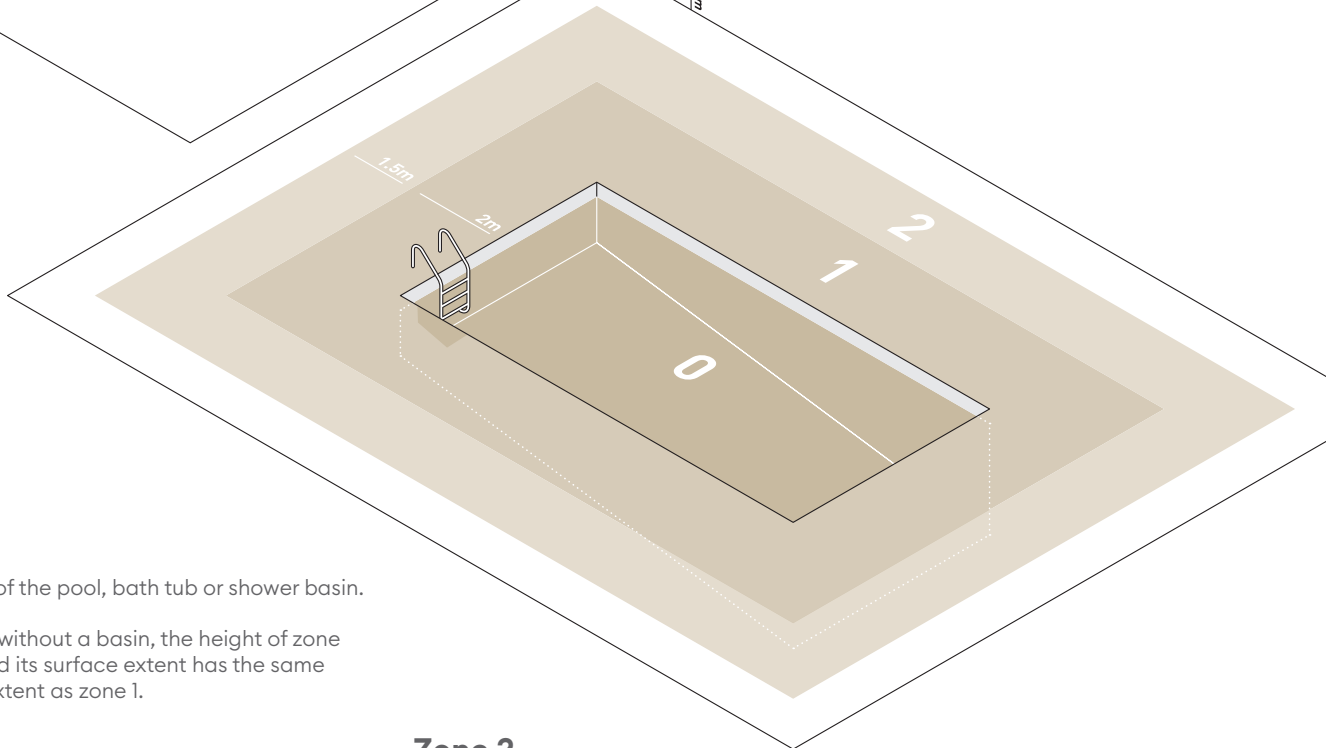
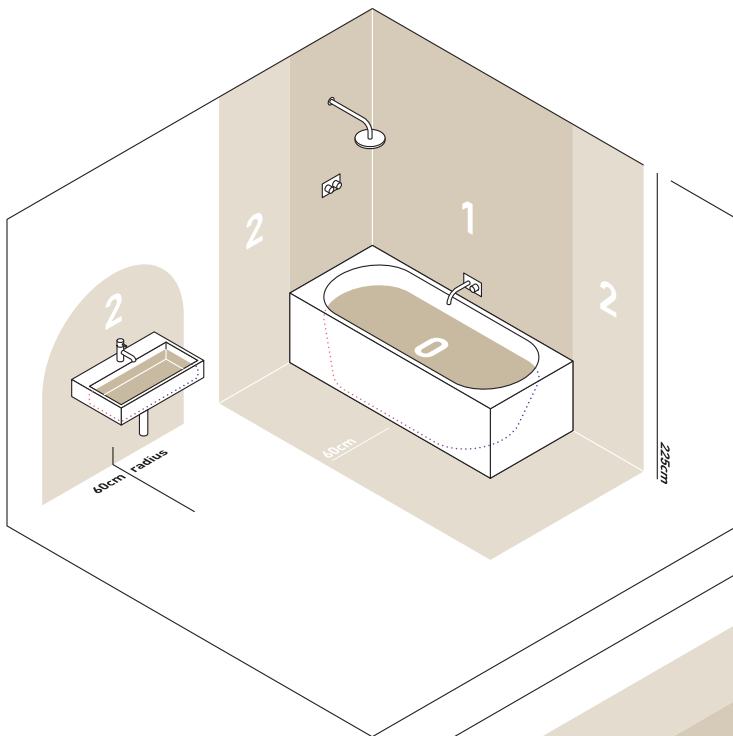

Zone 0

The interior of the pool, bath tub or shower basin.

For showers without a basin, the height of zone 0 is 10cm and its surface extent has the same horizontal extent as zone 1.

Zone 1

This is the three-dimensional space between the following boundaries:

Horizontal plane corresponding to the highest fixed shower head or water outlet or the horizontal plane lying 2.25m above the finished floor level.

Vertical plane circumscribing the bath tub or shower.

Note: For showers without a basin, the limiting vertical plane of zone 1 is at a distance of 1.2m from the centre point of the fixed water outlet on the wall or ceiling.

Zone 2

This is the three-dimensional space between the following boundaries:

Horizontal plane: Between the finished floor level and the highest point of either the highest fixed shower head or water outlet or 2.25m above the finished floor level.

Vertical plane: The parallel vertical surface that is 60cm from the zone 1 border.

Note: For showers without a basin there is no zone 2. An increased zone 1 is provided by the horizontal height of 1.2m.

BLO1DIB27.....	126	FL05BXCS.....	156	GL019SSLG30F.....	30	GL100SS2O40.....	35
BLO1DIB30.....	126	FL05WPCS.....	156	GL019SSLG30S.....	30	GL100SS2W22.....	35
BLO1DIB40.....	126	FL05WXCS.....	156	GL019SSLG40F.....	30	GL100SS2W27.....	35
BLO1DIS30.....	126	FL10BXCS.....	157	GL019SSLG40S.....	30	GL100SS2W30.....	35
BLO1FIB30.....	126	FOUX167N30.....	101	GL019USS22F.....	31	GL100SS2W40.....	35
BLO1FIS30.....	126	FOUX167RGBW.....	189	GL019USS22S.....	31	GL100SS3W22.....	36
BLO1PIB27.....	126	GH220B.....	89	GL019USS27F.....	31	GL100SS3W27.....	36
BLO1PIB30.....	126	GH220D.....	89	GL019USS27S.....	31	GL100SS3W30.....	36
BLO1PIS27.....	126	GH220Z.....	89	GL019USS30F.....	31	GL100SS3W40.....	36
BLO1PIS30.....	126	GL016RGBW.....	186	GL019USS30S.....	31	GL100SS4W22.....	37
BLO1PIS40.....	126	GL016RSS22F.....	45	GL019USS40F.....	31	GL100SS4W27.....	37
BLO3DIB30.....	127	GL016RSS22S.....	45	GL019USS40S.....	31	GL100SS4W30.....	37
BLO3DIS27.....	127	GL016RSS27F.....	45	GL021 27.....	70	GL100SS4W40.....	37
BLO3DIS30.....	127	GL016RSS27S.....	45	GL021 NW.....	70	GL200AX1X30.....	42
BLO3FIB30.....	127	GL016RSS30F.....	45	GL022 27.....	71	GL200AX2130.....	42
BLO3FIS27.....	127	GL016RSS30S.....	45	GL022 NW.....	71	GL200AX2230.....	42
BLO3FIS30.....	127	GL016RSS40F.....	45	GL022 WW.....	71	GL200AX3X30.....	43
BLO3FIS40.....	127	GL016RSS40S.....	45	GL034SS22MF.....	69	GL200AX4X30.....	43
BLO3PIB30.....	127	GL016SQSS27F.....	51	GL034SS22XF.....	67	GL200DX1X27.....	39
BLO3PIS27.....	127	GL016SQSS30F.....	51	GL034SS27MF.....	69	GL200DX1X30.....	39
BLO3PIS30.....	127	GL016SQSS40F.....	51	GL034SS27XF.....	67	GL200DX1X40.....	39
BLO3PIS40.....	127	GL016SSFD22.....	46	GL034SS30MF.....	69	GL200DX2127.....	39
BLSAG3RDCS.....	134	GL016SSFD27.....	46	GL034SS30XF.....	67	GL200DX2130.....	39
BLSAG6RDCS.....	134	GL016SSFD30.....	46	GL034SS40MF.....	69	GL200DX2140.....	39
BLSBK3RDCS.....	134	GL016SSFD40.....	46	GL034SS40XF.....	67	GL200DX2227.....	39
BLSBK6RDCS.....	134	GL016SSHM22.....	50	GL038SS22MF.....	58	GL200DX2230.....	39
BLSCN3RDCS.....	134	GL016SSHM27.....	50	GL038SS22XF.....	58	GL200DX2240.....	39
BLSCN6RDCS.....	134	GL016SSHM30.....	50	GL038SS27MF.....	59	GL200DX3X27.....	40
BOL LED BRACKET.....	128	GL016SSHM40.....	50	GL038SS27XF.....	58	GL200DX3X30.....	40
BOL100X30.....	131	GL016SSLG22F.....	48	GL038SS30MF.....	59	GL200DX4X27.....	40
BOL101X30.....	131	GL016SSLG22S.....	48	GL038SS30XF.....	58	GL200DX4X30.....	40
BOL201X30.....	132	GL016SSLG27F.....	48	GL038SS40MF.....	59	GL200DX4X40.....	40
BOL300X30.....	133	GL016SSLG27S.....	48	GL038SS40XF.....	58	GLTMF147T30.....	61
BOL301X30.....	133	GL016SSLG30F.....	48	GL040RSS22F.....	52	GLTMF165T30.....	61
CCDRVI00DALI.....	182	GL016SSLG30S.....	48	GL040RSS22S.....	52	GLTMS119T30.....	61
CCDRVI00DMX.....	182	GL016SSLG40F.....	48	GL040RSS27F.....	52	GLTMS147T30.....	61
CCDRVI00RF.....	182	GL016SSLG40S.....	48	GL040RSS27S.....	52	GLTMS165T30.....	61
CCDRV200DALI.....	182	GL016USS22F.....	49	GL040RSS30F.....	52	GLTMS193T30.....	61
CCDRV200DMX.....	182	GL016USS27F.....	49	GL040RSS30S.....	52	GLTMS223T30.....	61
CCDRV200RF.....	182	GL016USS30F.....	49	GL040RSS40F.....	52	GLTXS119RGBW.....	192
CCDRV75DALI.....	182	GL016USS40F.....	49	GL040RSS40S.....	52	GLTXS147RGBW.....	192
CCDRV75DMX.....	182	GL018 C 27.....	24	GL040SSFD22.....	53	GLTXS165RGBW.....	192
CCDRV75RF.....	182	GL018 C AB WW.....	24	GL040SSFD27.....	53	GLTXS193RGBW.....	193
CCREMOTEB.....	180	GL018 C NW.....	24	GL040SSFD30.....	53	GLTXS223RGBW.....	193
CCRFCONVWIFI.....	181	GL018 C WW.....	24	GL040SSFD40.....	53	GS220B.....	89
CCWALLRFB.....	180	GL018 SQ WW.....	25	GL040SSHM22.....	56	GS220D.....	89
CCWALLRFW.....	180	GL019E27BL.....	66	GL040SSHM27.....	56	GS220Z.....	89
CF505RGBW.....	185	GL019E27SS.....	66	GL040SSHM30.....	56	H2EXTIA.....	147
COLLINGWOODRGBW APP.....	181	GL019E30BL.....	66	GL040SSHM40.....	56	H2EXTIB.....	147
CR575RGBW.....	185	GL019E30SS.....	66	GL040SSLG22F.....	54	H2EXTIW.....	147
DRV150700.....	206 - 211	GL019RSS22F.....	27	GL040SSLG22S.....	54	JB1.....	212
DRV350700TD.....	206 - 211	GL019RSS22S.....	27	GL040SSLG27F.....	54	JB2.....	212
FL01APCS.....	152	GL019RSS27F.....	27	GL040SSLG27S.....	54	JB3.....	212
FL01AXCS.....	152	GL019RSS27S.....	27	GL040SSLG30F.....	54	JB4.....	212
FL01BPCS.....	152	GL019RSS30F.....	27	GL040SSLG30S.....	54	JB5.....	212
FL01BXCS.....	152	GL019RSS30S.....	27	GL040SSLG40F.....	54	JB6.....	212
FL01WPCS.....	152	GL019RSS40F.....	27	GL040SSLG40S.....	54	JB7.....	212
FL01WXCS.....	152	GL019RSS40S.....	27	GL040USS22F.....	55	LED LYTE 1M EXT.....	119
FL02APCS.....	153	GL019SQSS30F.....	33	GL040USS22S.....	55	LED LYTE 6 WAY EXT.....	119
FL02AXCS.....	153	GL019SQSS40F.....	33	GL040USS27F.....	55	LED LYTE IP 27.....	117
FL02BPCS.....	153	GL019SQSS40S.....	33	GL040USS27S.....	55	LED LYTE IP NW.....	117
FL02BXCS.....	153	GL019SSFD22.....	28	GL040USS30F.....	55	LED LYTE IP T NW.....	118
FL02WPCS.....	153	GL019SSFD27.....	28	GL040USS30S.....	55	LED LYTE IP WW.....	117
FL02WXCS.....	153	GL019SSFD30.....	28	GL040USS40F.....	55	LEDRGBWEXT.....	185
FL03APCS.....	155	GL019SSFD40.....	28	GL040USS40S.....	55	LL1000AT27.....	143
FL03AXCS.....	155	GL019SSHM22.....	32	GL090RGBW.....	187	LL1000AT30.....	143
FL03BPCS.....	155	GL019SSHM27.....	32	GL100SSIW22.....	34	LL1000MT27.....	143
FL03BXCS.....	155	GL019SSHM30.....	32	GL100SSIW27.....	34	LL1000MT30.....	143
FL03WPCS.....	155	GL019SSHM40.....	32	GL100SSIW30.....	34	LL1000WT27.....	143
FL03WXCS.....	155	GL019SSLG22F.....	30	GL100SSIW40.....	34	LL1000WT30.....	143
FL05APCS.....	156	GL019SSLG22S.....	30	GL100SS2O22.....	35	LL500AT27.....	142
FL05AXCS.....	156	GL019SSLG27F.....	30	GL100SS2O27.....	35	LL500AT30.....	142
FL05BPCS.....	156	GL019SSLG27S.....	30	GL100SS2O30.....	35	LL500MT27.....	142

Index

LL500MT30.....	142	ML01 WW.....	116	SPYA3FCS.....	90	WL342NW.....	75
LL500WT27.....	142	OUI3624.....	137	SPYA6DCS.....	91	WL342WW.....	75
LL500WT30.....	142	OUI3824.....	135	SPYA6FCS.....	91		
LSC8227200.....	168	PDCINTI-10V.....	206 - 211	SPYB3DCS.....	92		
LSC8230200.....	168	PLD UNI-DRIVE 350MA.....	206 - 211	SPYB3FCS.....	92		
LSC8240200.....	168	PLD UNI-DRIVE 700MA.....	206 - 211	SPYB6DCS.....	93		
LSC8427400.....	170	PLDM7001I.....	206 - 211	SPYB6FCS.....	93		
LSC8430400.....	170	PR301I.....	184	TUBE/50.....	60		
LSC8440400.....	170	PSI524.....	206 - 211	TUBE/68.....	60		
LSC8527400.....	169	PS3024B.....	206 - 211	TUBE332.....	60		
LSC8530400.....	169	PS7524.....	206 - 211	UL010RGBW.....	190		
LSC8540400.....	169	PSDAL20024.....	206 - 211	UL010SS22XF.....	100		
LSC8627400.....	171	PSDAL350M.....	206 - 211	UL010SS27XF.....	100		
LSC8630400.....	171	PSDAL700M.....	206 - 211	UL010SS30XF.....	100		
LSC8640400.....	171	PSDAL900M.....	206 - 211	UL010SS40XF.....	100		
LSDI2024.....	206 - 211	PSDIM180.....	206 - 211	UL030RGBW.....	191		
LSD6024.....	206 - 211	PSDIM350.....	206 - 211	UL030SS22XF.....	99		
LSNSI2I7B2P.....	164	PSDIM700.....	206 - 211	UL030SS22XS.....	99		
LSNSI2I7E2P.....	164	PSDIM900.....	206 - 211	UL030SS27XF.....	99		
LSNSI2I7EC.....	164	PSDIP10024.....	206 - 211	UL030SS27XS.....	99		
LSNSI2I7L2P.....	164	PSIP15024.....	206 - 211	UL030SS30XF.....	99		
LSNSI2I7MAL.....	162	PSIP25024.....	206 - 211	UL030SS30XS.....	99		
LSNSI2I7MPC.....	162	PSIP35018W.....	206 - 211	UL030SS40XF.....	99		
LSNSI2I7PAL.....	162	PSIP3509W.....	206 - 211	UL030SS40XS.....	99		
LSNSI2I7PFL.....	162	PSIP70018W.....	206 - 211	UY2 CONNECTOR.....	213		
LSNSI2I7PPC.....	162	PSIP70036W.....	206 - 211	WC 5-9.....	212		
LSNSI2I7R2P.....	164	PSMD3024.....	206 - 211	WCR 275 BLACK.....	213		
LSNSI2I7SS.....	164	PSMDIP10024.....	206 - 211	WCR 375 BLACK.....	213		
LSNSI2I7SSF.....	164	RP28020.....	122	WL012G30.....	111		
LSNS7327030.....	172	SL030 F 27.....	80	WL012X30.....	111		
LSNS7327050.....	172	SL030 F NW.....	80	WL041 IP NW.....	115		
LSNS7327100.....	172	SL030 F WW.....	80	WL041 IP WW.....	115		
LSNS7330030.....	172	SL040A F 27.....	81	WL060 NW.....	110		
LSNS7330050.....	172	SL040A F WW.....	81	WL060 WW.....	110		
LSNS7330100.....	172	SL040A S 27.....	81	WL070BNBM27.....	107		
LSNS7340030.....	172	SL040A S NW.....	81	WL070BNBM30.....	107		
LSNS7340050.....	172	SL040A S WW.....	81	WL070BNBM40.....	107		
LSNS7340100.....	172	SL13027.....	80	WL070CNBM27.....	107		
LSNS7527030.....	173	SL13030.....	80	WL070CNBM30.....	107		
LSNS7527050.....	173	SL13040.....	80	WL070RGBW.....	194		
LSNS7530030.....	173	SL220SS22MF.....	83	WL070SNBM27.....	107		
LSNS7530050.....	173	SL220SS22MS.....	83	WL070SNBM30.....	107		
LSNS7540030.....	173	SL220SS22XF.....	82	WL070SNBM40.....	107		
LSNS7540050.....	173	SL220SS22XS.....	82	WL070ZNB27.....	107		
LSNTI3I2B2P.....	164	SL220SS27MF.....	83	WL070ZNB30.....	107		
LSNTI3I2E2P.....	164	SL220SS27MS.....	83	WL075BNBM27.....	109		
LSNTI3I2EC.....	164	SL220SS27XF.....	82	WL075BNBM30.....	109		
LSNTI3I2L2P.....	164	SL220SS27XS.....	82	WL075BNBM40.....	109		
LSNTI3I2MAL.....	163	SL220SS30MF.....	83	WL075SNBM27.....	109		
LSNTI3I2MPC.....	163	SL220SS30MS.....	83	WL075SNBM30.....	109		
LSNTI3I2PAL.....	163	SL220SS30XF.....	82	WL075SNBM40.....	109		
LSNTI3I2PFL.....	163	SL220SS30XS.....	82	WL075ZNB27.....	109		
LSNTI3I2PPC.....	163	SL220SS40MF.....	83	WL075ZNB30.....	109		
LSNTI3I2R2P.....	164	SL220SS40MS.....	83	WL160 27.....	110		
LSNTI3I2SS.....	164	SL220SS40XF.....	82	WL160 NW.....	110		
LSNTI3I2SSF.....	164	SL220SS40XS.....	82	WL160 WW.....	110		
LSNT7327030.....	174	SL230BWB27.....	87	WL220SS22MF.....	108		
LSNT7327050.....	174	SL230BWB30.....	87	WL220SS22MS.....	108		
LSNT7327100.....	174	SL230BWBX27.....	86	WL220SS27MF.....	108		
LSNT7330030.....	174	SL230BWBX30.....	86	WL220SS27MS.....	108		
LSNT7330050.....	174	SL230DWB27.....	87	WL220SS30MF.....	108		
LSNT7330100.....	174	SL230DWB30.....	87	WL220SS30MS.....	108		
LSNT7340030.....	174	SL230DWB30.....	86	WL220SS40MF.....	108		
LSNT7340050.....	174	SL230ZWB30.....	87	WL220SS40MS.....	108		
LSNT7340100.....	174	SL230ZWBX27.....	86	WL339WW.....	72		
LSNT7527030.....	175	SL230ZWBX30.....	86	WL340AB27.....	73		
LSNT7527050.....	175	SLM230SHA30.....	85	WL340ABWW.....	73		
LSNT7530030.....	175	SLM230SHB30.....	85	WL340WW.....	73		
LSNT7530050.....	175	SLX230SHA30.....	84	WL341NW.....	74		
LSNT7540030.....	175	SLX230SHB30.....	84	WL341WW.....	74		
LSNT7540050.....	175	SM28010.....	122	WL34227.....	75		
ML01 27.....	116	SM28020.....	122	WL342AB27.....	75		
ML01 NW.....	116	SPYA3DCS.....	90	WL342AB30.....	75		

Collingwood Lighting Limited terms and conditions of trading

1. Interpretation

- 1.1 In these Conditions the following words have the following meanings:
"Buyer" the person(s), firm or company from whom an order to supply Goods is received by the Company;
"Buyer Materials" any documents or other materials and any data or other information provided by the Buyer relating to the Goods;
"Company" Collingwood Lighting Limited, a company incorporated in England and Wales (company number 900626) whose registered office is at Brooklands House, Sywell Aerodrome, Sywell, Northampton, NN6 0BT.
"Company Materials" any documents or other materials, and any data or other information provided by the Company relating to the Goods;
"Conditions" the standard terms and conditions of sale as set out in this document together with any special terms and conditions agreed in writing between the Buyer and the Company.
"Contract" any contract between the Company and the Buyer for the sale of Goods;
"Delivery Point" the place where delivery of the Goods is to take place under Condition 4.1;
"Goods" any goods (or parts thereof) to be supplied to the Buyer by the Company.
1.2 In these Conditions, references to any statute or statutory provision shall, unless the context otherwise requires, be construed as a reference to that statute or statutory provision as from time to time amended, consolidated, modified, extended, re-enacted or replaced; references to the masculine include the feminine and the neuter and to the singular include the plural and vice versa as the context requires; and headings will not affect the construction of these Conditions.

2. Application of terms

- 2.1 These Conditions apply to all the Company's sales of Goods and any variation to these Conditions and any representations about the Goods shall have no effect unless expressly agreed in writing and signed by a director of the Company.
2.2 No terms or conditions endorsed upon, delivered with or contained in the Buyer's purchase order, confirmation of order or other document will form part of the Contract simply as a result of such document being referred to in the Contract.
2.3 Each order for Goods by the Buyer from the Company shall be deemed to be an offer by the Buyer to purchase Goods subject to these Conditions.
2.4 Orders should be in writing, and should state the Buyer's relevant order number. Verbal orders will be accepted but the Buyer will be responsible for any errors of description or quantity or date of delivery in Goods supplied thereunder.
2.5 No order placed by the Buyer shall be deemed to be accepted by the Company until the Company issues a written acknowledgement or (if earlier) the Company delivers the Goods to the Buyer.
2.6 The Buyer must ensure that the terms of any order or related document are complete and accurate.
2.7 Unless otherwise stated any quotation is valid for a period of 30 days only from its date, provided that the Company has not previously withdrawn it.
2.8 A credit limit applies to every account and will be disclosed on request or will be automatically disclosed if the Buyer's order would cause the credit limit to be exceeded.

3. Description

- 3.1 The description of the Goods shall be as set out in the Company's price list.
3.2 All descriptive matter and advertising issued by the Company and any descriptions or illustrations contained in the Company's documentation are issued or published for the sole purpose of giving an approximate idea of the Goods described in them. They will not form part of this Contract.
3.3 The Buyer should always ensure that the Goods ordered are suitable for the intended purpose before commencing installation, bulk production or investment in tooling.

4. Delivery

- 4.1 Unless otherwise agreed in writing by the Company delivery of the Goods shall take place at the address detailed in the Buyer's order.
4.2 Any dates specified by the Company for delivery of the Goods are intended to be an estimate and time for delivery shall not be made of the essence by notice.
4.3 Subject to the other provisions of these Conditions the Company will not be liable for any loss (including loss of profit), costs, damages, charges or expenses caused directly or indirectly by any delay in the delivery of the Goods (even if caused by the Company's negligence), nor will any delay entitle the Buyer to terminate the Contract.
4.4 If for any reason the Buyer does not accept delivery of any of the Goods, or the Company is unable to deliver the Goods on time because the Buyer has not provided appropriate instructions, documents, licences or authorisations; risk in the Goods will pass to the Buyer (including loss or damage caused by negligence); the Goods will be deemed to have been delivered; and the Company may store the Goods until delivery whereupon the Buyer will be liable for all related costs and expenses (including without limitation storage and insurance).
4.5 The Buyer will provide at its expense at the Delivery Point adequate and appropriate equipment and manual labour for loading the Goods.
4.6 The Company may deliver the Goods by instalments and each instalment shall be treated as a separate Contract so that failure to deliver or defect in one or more instalment shall not entitle the Buyer to reject the other instalments.

5. Non-Delivery

- 5.1 The quantity of any consignment of Goods as recorded by the Company upon despatch from the Company's place of business shall be conclusive evidence of the quantity received by the Buyer.
5.2 The Company shall not be liable for any non-delivery of Goods (even if caused by the Company's negligence) unless written notice is given to the Company within 3 days of the date when the Goods would in the ordinary course of events have been received.
5.3 Any liability of the Company for non-delivery of the Goods shall be limited to replacing the Goods within a reasonable time or issuing a credit note at the pro rata Contract rate against any invoice raised for such Goods.

6. Risk/Title

- 6.1 The Goods are at the risk of the Buyer from the time of delivery.
6.2 Ownership of the Goods shall not pass to the Buyer until the Company has received in full (in cash or cleared funds) all sums due to it from the Buyer on any account.
6.3 Until ownership of the Goods has passed to the Buyer, the Buyer must: hold the Goods on a fiduciary basis as the Company's bailee; store the Goods (at no cost to the Company) separately from all other goods in such a way that they remain readily identifiable as the Company's property; not destroy, deface or obscure any identifying mark or packaging on or relating to the Goods; maintain the Goods in satisfactory condition insured on the Company's behalf for their full price against all risks to the reasonable satisfaction of the Company. (On request the Buyer shall produce the policy of insurance to the Company and hold the proceeds of the insurance referred to in on trust for the Company and not mix them with any other money, nor pay the proceeds into an overdrawn bank account).
6.4 The Buyer may resell the Goods before ownership has passed to it on the following conditions:
6.4.1 any sale shall be effected in the ordinary course of the Buyer's business at full market value; and
6.4.2 any such sale shall be a sale of the Company's property on the Buyer's own behalf and the Buyer shall deal as principal when making such a sale.
6.5 If the Buyer resells any of the Goods on a retail basis it will be responsible for complying with all applicable laws and for the provision of proper labels and instructions as required by the Department of Trade and Industry and/or any other authority for the time being empowered to make any requirements as to the sale or installation of such Goods.
6.6 The Buyer's right to possession of the Goods shall terminate immediately if:
6.6.1 the Buyer has a bankruptcy order made against him or makes an arrangement or composition with his creditors, or otherwise takes the benefit of any relief for insolvent debtors, or (being a body corporate) convenes a meeting of creditors (whether formal or informal), or enters into liquidation except a solvent voluntary liquidation for the purpose of reconstruction or amalgamation, or has a receiver and/or manager, administrator or administrative receiver appointed of its undertaking or any part thereof, or a resolution is passed or a petition presented to any court for the winding up of the Buyer or for the granting of an administration order in respect of the Buyer, or any proceedings are commenced relating to the insolvency or possible insolvency of the Buyer; or
6.6.2 the Buyer suffers or allows any execution, whether legal or equitable, to be levied on his/its property or obtained against him/it, or fails to observe/performs any of his/its obligations under the Contract or any other contract between the Company and the Buyer, or is unable to pay its debts within the meaning of section 123 of the Insolvency Act 1986 or the Buyer ceases to trade; or
6.6.3 the Buyer encumbers or in any way charges any of the Goods.
6.7 The Company shall be entitled to recover payment for the Goods notwithstanding that ownership of any of the Goods has not passed from the Company.
6.8 The Buyer grants the Company, its agents and employees an irrevocable licence at any time to enter any premises where the Goods are or may be stored in order to inspect them, or, where the Buyer's right to possession has terminated, to recover them.

7. Price

- 7.1 Unless otherwise agreed by the Company in writing (and except in cases of obvious error) the price for the Goods shall be the price set out in the Company's price list as in force at the date of invoice.
7.2 Where the Company and the Buyer agree a discount in respect of the Company's price list any such discount will only apply where confirmed by the Company in writing and where payment is received from the Buyer in full within 14 days of it falling due.
7.3 If the Buyer is paying for Goods on a "pro-forma" basis (whether due to slow payment or otherwise) no discount to the price stated in the Company's price list will apply notwithstanding any prior arrangement to the contrary unless the discount is confirmed by a director of the Company in writing.
7.4 The Company reserves the right, by giving notice to the Buyer to increase the price of the Goods to reflect any increase in the cost to the Company which is due to any factor beyond the control of the Company, any change in delivery dates or quantities specified by the Buyer or any delay caused by the instructions of the Buyer or failure of the Buyer to provide adequate information or instructions.
7.5 The price for the Goods shall be exclusive of any value added tax which shall be paid at the rate and in the manner for the time being provided by law.
7.6 Carriage will be paid by the Company on Goods bought in accordance with its current conditions for delivery on the UK mainland. Further charges may apply where alternative delivery terms are agreed.
7.7 A handling charge of £5.50 will be added to orders with a Goods value of less than the current minimum order value stipulated by the Company's sales office from time to time.
7.8 Invoices credited as a result of Buyer error will attract a service charge of 15% if returned within 21 days. Between 22 days and 3 months a charge of 30% will apply.

8. Payment

- 8.1 The price for Goods is due within 30 days of the end of the month in which it is invoiced unless specified differently on the invoice. Time for payment shall be of the essence.
8.2 No payment shall be deemed to have been received until the Company has received cleared funds.
8.3 All payments payable to the Company under the Contract shall become due immediately upon termination of this Contract despite any other provision.
8.4 The Buyer shall make all payments due under the Contract without any deduction whether by way of set-off, counterclaim, discount, abatement or otherwise unless the Buyer has a valid court order requiring an amount equal to such deduction to be paid by the Company to the Buyer.
8.5 If the Buyer fails to pay the Company any sum due pursuant to the Contract the Buyer will be liable to pay interest to the Company on such sum from the due date for payment at the annual rate of 5% above the base lending rate published from time to time by the Bank of England, accruing on a daily basis until payment is made, whether before or after any judgment.

9. Quality

- 9.1 The Company warrants that (subject to the other provisions of these Conditions) upon delivery, the Goods will be of satisfactory quality within the meaning of the Sale of Goods Act 1979.
9.2 The Company shall not be liable for a breach of the warranty in Condition 9.1 unless: the Buyer gives written notice of the defect to the Company, and (if the defect is as a result of damage in transit) to the carrier, within 14 days of delivery; and the Company is given a reasonable opportunity after receiving the notice of examining such Goods and the Buyer (if asked to do so by the Company) returns such Goods to the Company's place of business at the Buyer's expense for the examination to take place.
9.3 The Company shall not be liable for a breach of the warranty in Condition 9.1 if the Buyer makes any further use of such Goods after giving such notice; or the defect arises because the Buyer failed to follow the Company's oral or written instructions as to the storage, installation, commissioning, use or maintenance of the Goods or (if there are none) good trade practice; or the Buyer alters or repairs such Goods without the written consent of the Company.
9.4 Subject to Conditions 9.2 and 9.3, if any of the Goods do not conform with the warranty in Condition 9.1 the Company shall at its option repair or replace such Goods (or the defective part) or refund the price of such Goods at the pro rata Contract rate provided that, if the Company so requests, the Buyer shall, at the Buyer's expense, return the Goods or the part of such Goods which is defective to the Company.
9.5 If the Company complies with Condition 9.4 it shall have no further liability for a breach of the warranty in Condition 9.1 in respect of such Goods.
9.6 Where a defect is discovered the Buyer will inform the Company immediately notwithstanding the expiry of the warranty period in Condition 9.2.

10. Limitation of liability (the buyer's attention is drawn to the provisions of this condition)

- 10.1 Subject to Condition 9, the following provisions of this Condition 10 set out the entire financial liability of the Company (including any liability for the acts or omissions of its employees, agents and sub-contractors) in respect of any breach of these Conditions and any representation, statement or tortious act or omission including negligence arising under or in connection with the Contract.
10.2 All terms implied by statute or common law (save for the conditions implied by section 12 of the Sale of Goods Act 1979) are, to the fullest extent permitted by law, excluded from the Contract.
10.3 Nothing in these Conditions excludes or limits the liability of the Company for death or personal injury caused by the Company's negligence or for fraudulent misrepresentation.
10.4 Subject to Conditions 10.2 and 10.3:
10.4.1 the Company's total liability in contract, tort (including negligence or breach of statutory duty), misrepresentation or otherwise, arising in connection with the performance or contemplated performance of this Contract shall be limited to the price paid by the Buyer; and
10.4.2 the Company shall not be liable to the Buyer for any indirect or consequential loss or damage (whether for loss of profit, loss of business, depletion of goodwill or otherwise), costs, expenses or other claims for consequential compensation (howsoever caused) which arise out of or in connection with the Goods.
10.5 The Buyer warrants that any installation of the Goods will be performed by properly trained staff and agrees that it shall be solely responsible for any use to which the Goods are put after delivery.

11. Intellectual property

- 11.1 The property and any copyright or other intellectual property rights in any Buyer Materials shall belong to the Buyer and any Company Materials shall, unless otherwise agreed in writing between the Buyer and the Company, belong to the Company, subject only to a licence in favour of the Buyer to use the Company Materials for the purposes of receiving the Goods.

12. Force majeure

- 12.1 The Company reserves the right to defer the date of delivery or to cancel the Contract or reduce the volume of the Goods ordered by the Buyer (without liability to the Buyer) if it is prevented from or delayed in the carrying on of its business due to circumstances beyond the reasonable control of the Company including, without limitation, acts of God, governmental actions, war or national emergency, riot, civil commotion, fire, explosion, flood, epidemic, lock-outs, strikes or other labour disputes (whether or not relating to either party's workforce), or restraints or delays affecting carriers or inability or delay in obtaining supplies of adequate or suitable materials.

13. General

- 13.1 Each right or remedy of the Company under the Contract is without prejudice to any other right or remedy of the Company whether under the Contract or not.
13.2 If any provision or part of a provision of the Contract is found by any court or other body of competent jurisdiction to be illegal, invalid, void, voidable, unenforceable or unreasonable it shall be deemed severable and the remaining provisions of the Contract and the remainder of such provision shall continue in full force and effect.
13.3 Failure or delay by the Company in enforcing or partially enforcing any provision of the Contract will not be construed as a waiver of any of its rights under the Contract. Any waiver by the Company of any breach of, or any default under, any provision of the Contract by the Buyer will not be deemed a waiver of any subsequent breach or default and will in no way affect the other terms of the Contract.
13.4 The parties to this Contract do not intend that any term of this Contract will be enforceable by virtue of the Contracts (Rights of Third Parties) Act 1999 by any person that is not a party to it.
13.5 The Buyer shall not be entitled to assign the Contract or any part of it without the prior written consent of the Company. The Company may assign the Contract or any part of it to any person, firm or company.
13.6 The formation, existence, construction, performance, validity and all aspects of the Contract shall be governed by English law and the parties submit to the exclusive jurisdiction of the English courts.



COLLINGWOOD
LIGHTING

Brooklands House, Sywell Aerodrome
Sywell Northampton, NN6 0BT
+44 (0) 1604 495 151
sales@collingwoodgroup.com
collingwoodlighting.com

Published March 2025

